

# MONROE®

## AMORTIGUADORES



# CATÁLOGO



SERVICIO LIGERO / 2023





AMORTIGUADORES

# PROVEEDOR GLOBAL DE EQUIPO ORIGINAL EN PRODUCTOS PARA EL CONTROL DE MANEJO



Somos proveedores líderes a nivel global para fabricantes de vehículos que ofrecen productos de clase mundial desarrollados y probados con los más altos estándares.

Nuestra red global avanzada de control de manejo así como nuestras plantas de ensamble ofrecen continuamente los estándares más altos para el desempeño, la durabilidad y la confiabilidad de nuestros productos.

**El liderazgo que tenemos en Equipo Original es parte de nuestro ADN... y está en nuestro nombre.**

## EL LÍDER EN LA INDUSTRIA

- Monroe es el líder en la industria, cuenta con más del 50% de participación en el mercado de **Aftermarket de Norte América.**
- Presencia global, Monroe opera **más de 30 fábricas en seis continentes.**
- Monroe el proveedor de **Equipo Original de más de 30 fabricantes de vehículos**, incluyendo:

- |                  |                       |
|------------------|-----------------------|
| - BMW            | - Nissan              |
| - Chrysler       | - Freightliner        |
| - Ford           | - Suzuki              |
| - General Motors | - Toyota              |
| - Lexus          | - Volvo               |
| - Mazda          | - Volkswagen          |
| - Mitsubishi     | - International Truck |

## COBERTURA

- Monroe cuenta con la mejor cobertura del mercado en un 94%
- Monroe es el proveedor que ofrece una línea completa de productos de control de manejo, con diversas aplicaciones, que incluyen:
- Servicio Pesado
- Amortiguadores para unidades de carga
- Amortiguador de cajuela
- Amortiguador de Dirección
- Bases de Amortiguador
- Suspensiones Autonivelables

## RECONOCIMIENTO DE MARCA

Monroe refuerza el mensaje de reemplazo recomendado por medio de la publicidad y campañas promocionales que llaman la atención de los consumidores ayudan a incrementar el tráfico en su negocio, **ofreciendo oportunidades adicionales para recomendar y cerrar más ventas.**

En Monroe estamos tan seguros de la calidad y la tecnología de los productos Premium en control de manejo, que **los invitamos a probarlos por 90 días**, si no cumplen con sus expectativas devuélvalos y le reemplazaremos con los productos de su preferencia.

Para mayores informes, vea la página VI del catálogo.



MONROE OFRECE UN PROGRAMA COMPLETO DE MERCADOTECNIA

# MONROE

AMORTIGUADORES



## EL SOPORTE QUE TÚ DEMANDAS

MONROE OFRECE EL MEJOR Y MÁS AMPLIO PROGRAMA DE LA INDUSTRIA PARA TU NEGOCIO

INSPECCIONE SUS  
AMORTIGUADORES Y STRUTS CADA  
**60,000 KMS.**

### CAMPAÑAS DE CONCIENTIZACIÓN AL CONSUMIDOR

Monroe refuerza su campaña de recomendar la inspección de **amortiguadores y struts cada 60,000 Km.** y la inspección del triángulo de seguridad por medio de campañas publicitarias y concientización al consumidor, esto le ayuda a poder recomendar y realizar más ventas.



### MEJORE SU SEGURIDAD Y SU EXPERIENCIA

Instale nuestros productos en su vehículo y **pruébelos durante 90 días.** le garantizamos que usted notará la diferencia experimentando la mejor sensación de manejo.

Si por alguna razón estos productos no cumplen con sus expectativas devuélvalos y le reemplazaremos con los productos de su preferencia de igual o menor precio, incluyendo el costo por la instalación.



### UN ESPECTRO DE TECNOLOGÍAS

Con las últimas tecnologías mundiales de válvulas de equipo original, los productos Monroe para el control de manejo están diseñados con la tecnología adecuada para cada vehículo y así para **proporcionar un control adicional para mejorar su experiencia de manejo.**



### MEDIOS DIGITALES

Conozca nuestra amplia cobertura a través de nuestra página web **Monroe México**, consulte nuevos lanzamientos y las características de nuestros producto en nuestro catálogo electrónico.



VISITE: [www.drivparts.com](http://www.drivparts.com)  
[www.monroe.com.mx](http://www.monroe.com.mx)



¡SÍGANOS EN FACEBOOK! Monroe México

# TECNOLOGÍAS INNOVADORAS



## MONROE OESPECTRUM

**Diseñado para un Control Excepcional  
Para: TODO tipo de vehículo**

Con la más reciente tecnología a nivel global de equipo original específica para cada uno de los vehículos proporcionando un control mejorado mientras reduce la rudeza que se experimenta al conducir en caminos irregulares.

Disponible:  
Auto de Pasajeros  
Camionetas  
Monotubo (Monotubo desde Equipo Original)  
Cartuchos  
Unidades Electrónicas (Aplicaciones selectas)

Garantía Comercial:  
Cuatro años o 300,000 kms.  
Garantía "Siente la Diferencia"  
Prueba Libre de Riesgo durante 90 días.

Serie: 5xxx, 37xxx, 39xxx, 7xxx



## MONROE REFLEX

**Diseñado para mejorar la Estabilidad y Control  
Para: Camionetas, SUVs y Vans**

Proporciona estabilidad mejorada al reducir la transferencia de peso al virar y al frenar, control mejorado bajo todas las condiciones de manejo.

Disponible:  
Camionetas  
SUVs y Vans  
Monotubo (Monotubo desde Equipo Original)

Garantía Comercial:  
Cuatro años o 300,000 kms.

Garantía "Siente la Diferencia"  
Prueba Libre de Riesgo durante 90 días.

Serie: 911xxx



## MONROE GAS MAGNUM

**Diseñado para un Manejo Firme  
Para: Camioneta Ligera y de Peso Completo**

Ingeniería aplicada para un control firme sin dureza al conducir. Con más del doble de capacidad para aceite que los amortiguadores convencionales.

Disponible:  
Camionetas

Garantía Comercial:  
Cuatro años o 300,000 kms.

Garantía "Siente la Diferencia"  
Prueba Libre de Riesgo durante 90 días.

Serie: 34xxx



## MONROE MONRO-MATIC

**Diseñado para un Manejo estilo Equipo Original  
Para: Auto de Pasajeros y Camionetas**

Proporcionan un ideal balance entre confort y control para todas las condiciones de manejo.

Disponible:  
Auto de Pasajeros  
Camionetas

Monro-Matic PLUS

Garantía Comercial:  
Cuatro años o 300,000 kms.

Serie: 31xxx, 32xxx, 33xxx y 80xxx

Monro-Matic HIDRÁULICO

Garantía Comercial:  
Dos años o 150,000 kms.

Serie: 1xxx, 2xxx, 3xxx, MCxxx y MWxxxx



## AMORTIGUADORES



### MONROE MAGNUM

**Amortiguadores de Dirección**  
**Para: Camioneta Ligera y de Peso Completo**

Actuando como un amortiguador horizontal, ayuda a reducir las vibraciones que van del sistema de dirección al conductor.

Disponible:  
Camionetas

Garantía Comercial:  
Cuatro años o 300,000 kms.

Serie: SCxxx y SAxxx

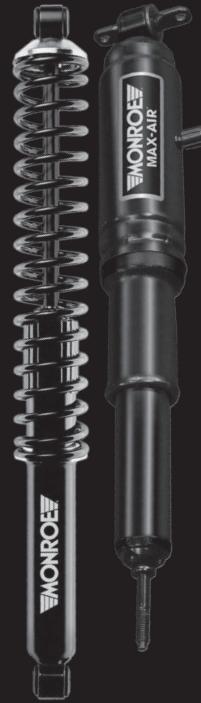

### MONROE LOAD-ADJUSTING Y MAX-AIR

**Diseñado para mantener la altura del vehículo**  
**Para: Vehículos que llevan peso extra o remolques**

Proporcionan un control mejorado bajo condiciones de peso extra o al remolcar sin comprometer el confort al conducir.

Disponible:  
Auto de Pasajeros  
Camionetas

Diseñados para brindar apoyo y mantener la altura de manejo hasta con 1,000 libras de peso adicional.

MAX-AIR ( Unidades ajustables con aire)

Garantía Comercial:  
Dos años o 50,000 kms.

Serie: Maxxx

LOAD-ADJUSTING (Unidades con resorte incluido)

Garantía Comercial: Dos años o 150,000 kms.

Serie: 58xxxx



### MONROE ROAD-MATIC

**Diseñados para el confort y control**  
**Para: Autos de pasajeros y camionetas**

Una alternativa económica de reemplazo confiable.

El fluido multigrado reduce la fricción y asegura una reacción suave del amortiguador o strut.

Brinda un desempeño en las necesidades de Equipo Original.

Disponible:  
Autos de pasajero  
Camionetas. (antes de garantía comercial)

Garantía comercial:  
Dos años o 100,000 kms

Serie: 250XXX Y 400XXX

### MONROE BASES DE AMORTIGUADOR

**Diseñadas para reducir el ruido y las vibraciones**  
**Para: Auto de Pasajeros, Camionetas, SUVs y Vans**

Al reemplazar sus amortiguadores debe utilizar bases de amortiguador para completar el servicio, diseñadas para reducir el ruido y las vibraciones, nuestra línea completa le proporcionará cobertura de equipo original de última generación.



Disponible:  
Auto de Pasajeros  
Camionetas, SUVs y Vans

Garantía Comercial:  
Dos años o 50,000 kms.

Serie: 90xxxx

# ÍNDICE

Cómo leer el catálogo Monroe	007
Números de parte retirados de catálogo	008
Números de parte obsoletos hasta agotar existencias	009
Números nuevos en catálogo	010
Índice por modelo	020
Simbología	027
Aplicaciones Monroe auto y camioneta	028
Aplicaciones Rancho amortiguadores para camionetas y SUV	149
Índice progresivo de aplicaciones	167
Tabla de medidas	232
Intercambios	254
Instrucciones importantes para la instalación	266
Puntos sorprendentes Monroe	269
Garantía automóviles y camionetas	270
Formato de Solicitud de Garantía	271



**AMORTIGUADORES**  
**Catálogo 2023**



## Como leer el catálogo Monroe

El catálogo cuenta con un índice por **MODELO** para encontrar la aplicación (vehículo) que está buscando. Los vehículos están ordenados en el catálogo por orden alfabético dentro de su marca.

• Por ejemplo, el auto March, puede encontrarlo dentro de la marca Nissan, ordenado de forma alfabética. Después del orden alfabético, los vehículos están ordenados por fecha, comenzando por los modelos más nuevos.

• Por ejemplo, primero encontrará las aplicaciones para los autos **Fusion Ikon 2013-2016**, después los que corresponden a los autos **Fusion 2010-2012 y así sucesivamente**.

Finalmente podrá encontrar la aplicación que necesita acomodada en su columna correspondiente por línea, sin embargo, tome en cuenta que:

**A) Los amortiguadores OESpectrum y Reflex se encuentran en las mismas columnas, encontrando primero el número correspondientes a OESpectrum y debajo el número correspondiente a Reflex.**

**B) Los amortiguadores Gas Magnum, las bases de Amortiguadores y Cubre Polvo se encuentran en la misma columna. (Los números de parte de Bases de Amortiguadores y Cubre Polvo se pueden identificar de acuerdo con el símbolo correspondiente).**

**C) De igual manera, los amortiguadores Monro-Matic Plus y Monro-Matic Hidráulico se encuentran en las mismas columnas, encontrando primero el número correspondiente a Monro-Matic Plus y debajo el número correspondiente a Monro-Matic Hidráulico.**

**D) Los amortiguadores RoadMatic, Load Adjusting y Max-Air se encuentran en la misma columna, encontrando primero el número correspondiente a Load Adjusting y abajo el número Max-Air. ( El número RoadMatic se identifica por contar con 6 dígitos 25XXXXX, 40XXXX)**

**E) Algunos números de parte tienen alguna característica especial por lo que le recomendamos observe las notas al pie de cada página**

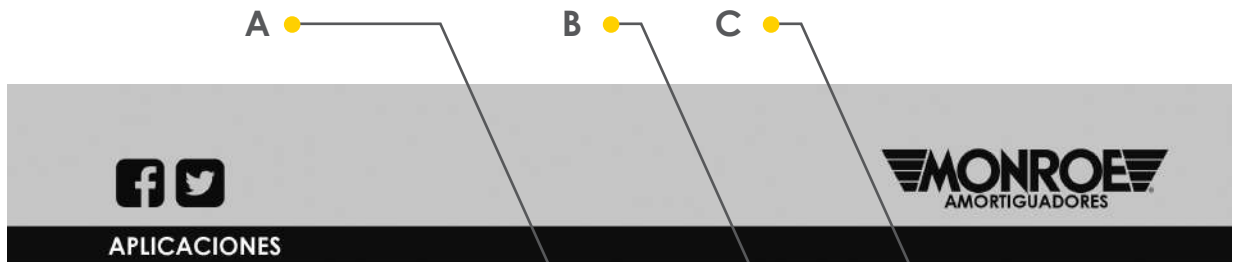

**DODGE — Pickup Ram 1500 (Cont.)**

2013-17	4WD Ram 1500 — c/ Suspension de Aire Exc. Off Road Suspension	—	911197	—	—	—	—	—	—
2019	4WD (1/2 Ton) Ram 1500 Classic — Exc. Susp. de Aire	72292	911299	907930	34795	—	—	—	—
	Kit de Bujes de Brazo de Control de la Susp.	—	—	908962	550060	—	—	—	—
	Asiento de Resorte Superior Para Remolque	—	—	907931	—	—	—	—	MA837
2009-18	4WD (1/2 Ton) Ram 1500 — Exc. Susp. de Aire	72292	911299	907930	34795	—	—	—	—
	Kit de Bujes de Brazo de Control de la Susp.	—	—	908962	550060	—	—	—	—
	Asiento de Resorte Superior Para Remolque	—	—	907931	—	—	—	—	MA837

● Nuevo número de parte

■ Número de parte bajo pedido especial

Ⓛ Unidad Premium que son considerados con vástago de extensión lenta.

Ⓜ Puede que se requiera el juego de piezas AK27 para reemplazar los tornillos y las tuercas originales del montaje inferior si están dañados o si no es posible reutilizarlos.

Ⓝ El compresor de resorte NO ES necesario para reemplazar los struts en este vehículo.

Ⓞ Solo utilice con Struts Monroe

E



## NÚMEROS DE PARTE RETIRADOS DEL CATÁLOGO

1196	63973	71679	72415	73036	907905
1198	71034	71682	72427	73037	907906
5508	71035	71683	72429	73245	907907
5535	71036	71760	72430	73267	907919
5633	71037	71771	72432	73453	907935
5669	71057	71779	72436	550061	907945
5782	71064	71798	72441	553022	907948
5945	71101	71822	72442	801020	907951
5959	71107	71837	72448	801022	907953
32103	71108	71838	72449	801347	907955
32228	71109	71858	72455	801358	907959
32230	71133	71881	72456	801437	907960
32299	71134	71882	72457	801438	907962
32317	71145	71888	72458	801451	907972
32344	71148	71921	72464	801579	907989
32371	71239	71922	72466	801592	907998
32384	71246	71940	72467	801593	908911
32393	71247	71941	72471	801594	908918
32394	71266	71973	72484	801597	908923
32545	71282	71980	72495	801598	908943
32592	71291	71993	72498	801831	908968
33152	71296	71994	72499	801860	908969
33153	71356	72113	72505	801880	908971
33191	71367	72116	72506	801942	908980
34671	71369	72122	72507	802117	908982
34693	71370	72124	72565	802123	908989
34774	71372	72126	72566	802276	908990
34780	71375	72130	72585	901903	908992
34806	71398	72135	72586	901913	909904
34929	71401	72141	72590	901926	909907
37038	71419	72171	72606	901999	909910
37051	71438	72183	72611	902927	909937
37060	71441	72184	72615	902936	909938
37090	71442	72195	72629	902937	909946
37095	71447	72201	72630	902941	909948
37130	71448	72202	72653	902947	909998
37132	71457	72206	72655	902948	911035
37144	71470	72236	72656	902954	911080
37146	71471	72244	72694	902999	911086
37149	71479	72250	72705	903914	911102
37150	71490	72251	72718	903924	911103
37155	71491	72266	72737	903926	911104
37196	71492	72268	72741	903933	911133
37206	71526	72282	72742	903957	911167
37220	71527	72284	72747	903991	911188
37233	71568	72285	72752	904919	911195
37247	71569	72304	72771	904927	911509
39014	71570	72331	72897	904939	911510

39042	71574	72336	72898	904942	911519
39043	71578	72337	72912	904963	911522
39050	71579	72340	72914	904971	911523
39113	71582	72344	72917	905923	911534
39137	71583	72348	72920	905968	MA826
39138	71585	72349	72980	906935	MW015
39139	71586	72350	72981	906938	MW751
40202	71587	72357	72987	906945	MW779
40211	71618	72359	72988	906961	SC2936
58620	71656	72394	73002	906997	SC2939
58640	71670	72397	73003	907900	
58651	71673	72414	73035	907901	





## NÚMEROS DE PARTE OBSOLETOS HASTA AGOTAR EXISTENCIAS

NÚMEROS DE PARTE OBSOLETOS CON REEMPLAZO					
No. de parte	Reemplazo	No. de parte	Reemplazo	No. de parte	Reemplazo
911102	34776	801347	71347	801594	71594
911103	34777	801358	71358	802123	72123
911522	34766	801593	71593	802276	72276
911523	34769				



## NUEVOS NÚMEROS EN CATÁLOGO

NÚM. PARTE	MARCA	APLICACIÓN	MOD.	POSICIÓN
------------	-------	------------	------	----------

OESPECTRUM AMORTIGUADOR					
5549	Chevrolet	Spark	2016-2022	Trasero	
5550	Honda	Insight	2010-2014	Trasero	
5551	Kia	Optima	2017-2020	Trasero	
	Hyundai	Sonata	2015-2019	Trasero	
5552	Nissan	Maxima	2016-2022	Trasero	
5553	Volkswagen	Jetta	2011-2014	Trasero	
5555	Toyota	Avalon	2019-2022	Trasero	
		Camry	2020-2022	Trasero	
5556	Mazda	6	2014-2017	Trasero	
		CX-5	2019-2021	Trasero	
5558	Mitsubishi	Mirage	2014-2017	Trasero	
5559	Honda	Accord	2018-2022	Trasero	
5560	Ford	C-Max	2013-2018	Trasero	
5561	Chevrolet	Cruze LS	2016-2019	Trasero	
		Volt	2016-2019	Trasero	
		Elantra	2017-2019	Trasero	
5562	Hyundai	Elantra	2017-2019	Trasero	
5566	Toyota	Yaris	2015-2018	Trasero	
37377	Kia	Sorento	2014-2015	Trasero	
		Hyundai	Santa Fe	2013-2018	Trasero
		Santa Fe Sport	2013-2018	Trasero	
37379	Kia	Sorento	2014-2015	Trasero	
		Hyundai	Santa Fe	2013-2018	Trasero
		Santa Fe Sport	2013-2018	Trasero	
37380	Jeep	Gladiator	2020-2022	Delantero	
		Wrangler	2018-2022	Delantero	
37382	Honda	CR-V	2017-2022	Trasero	
37387	Honda	Odyssey	2018-2022	Trasero	
37388	Ford	Ranger	2019-2022	Trasero	
37389	Ford	Edge	2015-2022	Trasero	
37390	Buick	Envision	2016-2020	Trasero	
	Chevrolet	Equinox	2018-2022	Trasero	
37390	GMC	Terrain	2018-2021	Trasero	
37392	Ford	EcoSport	2018-2021	Trasero	
37394	Jeep	Cherokee Limited	2019-2022	Trasero	

OESPECTRUM STRUT					
72639	Hyundai	Veracruz	2007-2012	Delantero	
73021	Jeep	Renegade	2015-2022	Delantero Der.	
73022	Jeep	Renegade	2015-2022	Delantero Izq.	
73023	Jeep	Renegade	2015-2018	Trasero Der.	
73024	Jeep	Renegade	2015-2018	Trasero Izq.	
73047	Hyundai	Santa Fe	2007-2009	Delantero	
73048	Nissan	Armada	2017-2022	Delantero	
		INFINITI	QX80	2014-2022	Delantero
		QX56	2011-2013	Delantero	

NÚM. PARTE	MARCA	APLICACIÓN	MOD.	POSICIÓN
------------	-------	------------	------	----------

OESPECTRUM STRUT				
73066	Kia	Soul	2014-2019	Delantero Der.
73067	Kia	Soul	2014-2019	Delantero Izq.
73068	Subaru	Forester	2014-2018	Delantero Der.
73069	Subaru	Forester	2014-2018	Delantero Izq.
73070	Subaru	XV Crosstrek	2013-2015	Delantero Der.
		Crosstrek	2016-2017	Delantero Der.
73071	Subaru	XV Crosstrek	2013-2015	Delantero Izq.
		Crosstrek	2016-2017	Delantero Izq.
73072	Kia	Optima	2016-2020	Delantero Der.
	Hyundai	Sonata	2015-2019	Delantero Der.
73073	Kia	Optima	2016-2020	Delantero Izq.
		Hyundai	Sonata	2015-2019
73074	Nissan	Rogue Sport	2017-2022	Delantero Der.
		Rogue	2014-2020	Delantero Der.
73075	Nissan	Rogue Sport	2017-2022	Delantero Izq.
		Rogue	2014-2020	Delantero Izq.
73076	Toyota	Tacoma	2016-2022	Delantero
73079	Subaru	Legacy	2013-2014	Delantero Der.
73080	Subaru	Legacy	2013-2014	Delantero Izq.
73081	Honda	Civic	2016-2022	Delantero
		Insight	2019-2022	Delantero
73082	Honda	Accord Crosstour	2010-2011	Delantero
		Crosstour	2012-2015	Delantero
73083	Honda	Crosstour	2012-2015	Delantero
73084	Subaru	Forester	2014-2017	Trasero
73085	Subaru	XV Crosstrek	2013-2015	Trasero
73086	Honda	Crosstour	2012-2015	Trasero
73087	Honda	Accord Crosstour	2010-2011	Trasero
		Crosstour	2012-2015	Trasero
73088	Toyota	Highlander	2014-2019	Delantero Der.
73089	Toyota	Highlander	2014-2019	Delantero Izq.
73090	Buick	LaCrosse	2017-2019	Delantero Der.
73091	Buick	LaCrosse	2017-2019	Delantero Izq.
73092	Toyota	Sienna	2015-2020	Delantero Der.
73093	Toyota	Sienna	2015-2020	Delantero Izq.
73094	Toyota	Sienna	2015-2020	Delantero Der.
73095	Toyota	Sienna	2015-2020	Delantero Izq.
73097	Honda	CR-V	2017-2022	Delantero Der.
73098	Honda	CR-V	2017-2022	Delantero Izq.
73099	Hyundai	Elantra	2017-2020	Delantero Der.
73100	Hyundai	Elantra	2017-2020	Delantero Izq.
73116	Chevrolet	Cheyenne	2019-2021	Delantero
	Chevrolet	Silverado 1500 LTD	2022-2022	Delantero
	Chevrolet	Silverado 1500	2019-2022	Delantero
	GMC	Sierra 1500 Limited	2022-2022	Delantero
	GMC	Sierra 1500	2019-2022	Delantero



## NUEVOS NÚMEROS EN CATÁLOGO

NÚM. PARTE	MARCA	APLICACIÓN	MOD.	POSICIÓN
------------	-------	------------	------	----------

### REFLEX AMORTIGUADOR

911547	Toyota	Tacoma	2016-2022	Trasero
--------	--------	--------	-----------	---------

### MONROMATIC PLUS AMORTIGUADOR

33200	Ford	Escape	2008-2012	Trasero
	Mercury	Mariner	2008-2011	Trasero
	Mazda	Tribute	2008-2011	Trasero
33202	Ford	Edge	2007-2010	Trasero
	Lincoln	MKX	2007-2010	Trasero
33203	Nissan	Versa	2007-2012	Trasero
		Tiida	2007-2012	Trasero
33204	Nissan	Murano	2009-2014	Trasero
33205	Nissan	Sentra	2007-2012	Trasero
33206	Ford	Edge	2011-2014	Trasero
	Lincoln	MKX	2011-2015	Trasero
33207	Saturn	Ion	2003-2007	Trasero
33208	Toyota	Tundra	2000-2006	Trasero
33209	Kia	Rio	2006-2011	Trasero
		Rio5	2006-2011	Trasero
	Hyundai	Accent	2006-2011	Trasero
	Dodge	Attitude	2006-2011	Trasero
33210	Mazda	3	2012-2013	Trasero
33212	Toyota	Sequoia	2001-2007	Trasero
33213	Toyota	Tundra	2000-2006	Trasero
33215	Nissan	Pathfinder	1999-2004	Trasero
	INFINITI	QX4	1999-2003	Trasero
33216	Dodge	Dart	2013-2016	Trasero
33217	Nissan	Murano	2003-2007	Trasero
		Titan	2004-2015	Trasero
33218	Nissan	Titan XD	2016-2022	Trasero
		Titan	2004-2015	Trasero
33219	Toyota	Prius	2010-2015	Trasero
		Prius Plug-In	2013-2015	Trasero
33221	Chrysler	300	2005-2010	Trasero
	Dodge	Challenger	2009-2010	Trasero
		Charger	2006-2010	Trasero
33222	Nissan	Magnum	2005-2008	Trasero
		Xterra	2005-2015	Trasero
33223	Nissan	Pathfinder Armada	2004-2004	Trasero
	Nissan	Armada	2005-2015	Trasero
33224	Nissan	Maxima	2004-2008	Trasero
33225	Nissan	Titan	2004-2015	Trasero
33226	Acura	RDX	2007-2012	Trasero

### ROADMATIC AMORTIGUADOR

250001	Nissan	Pickup D21 (Estacas)	1994-2008	Delantero
--------	--------	----------------------	-----------	-----------

NÚM. PARTE	MARCA	APLICACIÓN	MOD.	POSICIÓN
------------	-------	------------	------	----------

### ROADMATIC AMORTIGUADOR

250004	Ford	Explorer	1995-2001	Trasero
250005	Ford	Explorer	1991-1994	Delantero
250006	Ford	Explorer Sport	2001-2003	Delantero
		Explorer Sport Trac	2001-2005	Delantero
		Explorer	1995-2001	Delantero
		Ranger	1998-2011	Delantero
250007	Mercury	Mountaineer	1997-2001	Delantero
	Mazda	B3000	1998-2008	Delantero
250007		Ford	B4000	1998-2009
	Bronco II		1984-1990	Trasero
	Ranger		1983-1997	Trasero
	Ranger		1998-2011	Trasero
250007	Mazda	B2300	1994-2009	Trasero
		B2500	1998-2001	Trasero
		B3000	1994-2007	Trasero
		B4000	1994-2004	Trasero
250008	Ford	Explorer Sport	2001-2003	Delantero
		Explorer Sport Trac	2001-2005	Delantero
		Explorer	1995-2003	Delantero
250008	Mercury	Mountaineer	1997-2000	Delantero
250010	Ford	Focus	2012-2018	Trasero
250012	Suzuki	XL-7	2007-2009	Trasero
	Chevrolet	Captiva Sport	2008-2013	Trasero
	Chevrolet	Equinox	2005-2017	Trasero
	Chevrolet	Captiva	2008-2016	Trasero
	GMC	Terrain	2010-2017	Trasero
	Pontiac	Torrent	2006-2009	Trasero
	Saturn	Vue	2002-2010	Trasero
250013	Dodge	Nitro	2007-2012	Trasero
250013	Jeep	Liberty	2002-2012	Trasero
250014	Chevrolet	LUV	1998-2005	Trasero
250015	Chevrolet	Malibu	2004-2008	Trasero
250016	Chevrolet	LUV	1997-2005	Delantero
250017	Dodge	Ram 1500	1994-2001	Delantero
		Ram 2500	1994-2002	Delantero
		Ram 3500	1994-2002	Delantero
250018	Dodge	Ram 1500	1994-2001	Trasero
		Ram 2500	1994-2002	Trasero
		Ram 3500	1994-2002	Trasero
250019	Toyota	RAV4	2006-2018	Trasero
250020	Buick	Enclave	2008-2017	Trasero
	Chevrolet	Traverse	2009-2017	Trasero
	GMC	Acadia Limited	2017-2017	Trasero
		Acadia	2007-2016	Trasero
Saturn	Outlook	2007-2010	Trasero	



## NUEVOS NÚMEROS EN CATÁLOGO

NÚM. PARTE	MARCA	APLICACIÓN	MOD.	POSICIÓN
<b>ROADMATIC AMORTIGUADOR</b>				
250021	Kia	Rio	2006-2011	Trasero
		Rio5	2006-2011	Trasero
	Hyundai	Accent	2006-2011	Trasero
	Dodge	Attitude	2006-2011	Trasero

NÚM. PARTE	MARCA	APLICACIÓN	MOD.	POSICIÓN
<b>ROADMATIC STRUT</b>				
400008	Nissan	Sentra	2007-2012	Delantero Der.
400009	Nissan	Sentra	2007-2012	Delantero Izq.
400010	Chrysler	Cirrus	2007-2010	Delantero Der.
		Sebring	2007-2010	Delantero Der.
		200	2011-2014	Delantero Der.
	Dodge	Avenger	2008-2014	Delantero Der.
400011	Chrysler	Cirrus	2007-2010	Delantero Izq.
		Sebring	2007-2010	Delantero Izq.
		200	2011-2014	Delantero Izq.
	Dodge	Avenger	2008-2014	Delantero Izq.
400012	Ford	C-Max	2013-2018	Delantero Der.
		Focus	2012-2013	Delantero Der.
400013	Ford	C-Max	2013-2018	Delantero Izq.
		Focus	2012-2013	Delantero Izq.
400015	Toyota	RAV4	2006-2012	Delantero Der.
400016	Toyota	RAV4	2006-2012	Delantero Izq.
400018	Buick	Enclave	2008-2012	Delantero
	Chevrolet	Traverse	2009-2012	Delantero
	GMC	Acadia	2007-2012	Delantero
	Saturn	Outlook	2007-2010	Delantero
400019	Chevrolet	Malibu	2004-2012	Delantero Der.
	Pontiac	G6	2005-2010	Delantero Der.
	Saturn	Aura	2007-2009	Delantero Der.
400020	Chevrolet	Malibu	2004-2012	Delantero Izq.
	Pontiac	G6	2005-2010	Delantero Izq.
	Saturn	Aura	2007-2009	Delantero Izq.
400021	Seat	Altea	2005-2012	Delantero
	Volkswagen	Bora	2005-2010	Delantero
		Passat CC	2009-2012	Delantero
		Caddy	2014-2020	Delantero
		Golf SportWagen	2010-2013	Delantero
		Eos	2007-2016	Delantero
		CC	2011-2017	Delantero
		Beetle	2012-2019	Delantero
		Rabbit	2006-2009	Delantero
		Jetta	2005-2019	Delantero
		Golf	2010-2014	Delantero
Passat	2006-2022	Delantero		

NÚM. PARTE	MARCA	APLICACIÓN	MOD.	POSICIÓN
<b>ROADMATIC STRUT</b>				
400022	Chrysler	Town & Country	2001-2007	Delantero
		Voyager	2001-2003	Delantero
	Dodge	Caravan	2001-2007	Delantero
		Grand Caravan	2001-2007	Delantero
400032	Audi	A3 Quattro	2006-2013	Delantero
		A3	2005-2013	Delantero
	Volkswagen	Bora	2005-2010	Delantero
		Tiguan Limited	2018-2018	Delantero
		R32	2008-2008	Delantero
		Tiguan	2009-2017	Delantero
		GTI	2006-2014	Delantero
		Jetta	2005-2010	Delantero
		Passat	2006-2010	Delantero
	400033	Dodge	Caliber	2007-2012
2010-2012				Trasero
Jeep		Compass	2007-2010	Trasero
	Patriot	2007-2010	Trasero	
400034	Dodge	Caliber	2007-2012	Delantero Der.
	Jeep	Compass	2007-2010	Delantero Der.
		Patriot	2007-2010	Delantero Der.
400035	Dodge	Caliber	2007-2012	Delantero Izq.
	Jeep	Compass	2007-2010	Delantero Izq.
		Patriot	2007-2010	Delantero Izq.

NÚM. PARTE	MARCA	APLICACIÓN	MOD.	POSICIÓN
<b>BASES DE AMORTIGUADOR</b>				
902050	Acura	TL	2004-2008	Delantero
902051	Cadillac	XTS	2013-2019	Delantero
		SRX	2010-2015	Delantero
902052	Chevrolet	Colorado	2015-2022	Delantero
	GMC	Canyon	2015-2022	Delantero
902053	Dodge	Durango	2011-2015	Delantero
	Jeep	Grand Cherokee	2011-2015	Delantero
902054	Dodge	Journey	2011-2020	Trasero
902055	Honda	Accord	2013-2015	Trasero
902056	Honda	Accord	2013-2015	Delantero
902057	Honda	CR-V	2012-2016	Trasero
902058	Kia	Amanti	2004-2006	Delantero
902059	Mitsubishi	Galant	2004-2011	Trasero
902060	Nissan	Sentra	2013-2019	Delantero Der.
902061	Nissan	Sentra	2013-2019	Delantero Izq.
902062	Toyota	Corolla	2014-2016	Trasero Der.
902063	Toyota	Corolla	2014-2016	Trasero Izq.
902064	Toyota	Venza	2009-2012	Trasero Der.
902065	Toyota	Venza	2009-2012	Trasero Izq.



## NUEVOS NÚMEROS EN CATÁLOGO

NÚM. PARTE	MARCA	APLICACIÓN	MOD.	POSICIÓN
------------	-------	------------	------	----------

### BASES DE AMORTIGUADOR

902066	Subaru	Forester	2009-2013	Trasero
		Impreza	2008-2014	Trasero
902080	Kia	Soul	2010-2013	Delantero
902117	Hyundai	Elantra	2007-2012	Trasero
902123	Ford	Mondeo	2002-2007	Delantero
902125	Peugeot	306	1997-2003	Delantero
902126	Renault	Megane	2004-2010	Delantero
902127	Renault	Stepway	2010-2020	Delantero
		Duster	2011-2020	Delantero
		Logan	2015-2019	Delantero
		Captur	2017-2020	Delantero
	Nissan	Oroch	2018-2020	Delantero
902129	Volkswagen	Transporter	2010-2020	Delantero
		EuroVan	2006-2009	Delantero
902133	BMW	X5	2007-2013	Delantero
902133	BMW	X6	2008-2014	Delantero
902134	Cadillac	SRX	2004-2009	Delantero superior
		STS	2006-2011	Delantero superior
		CTS	2003-2014	Delantero superior
902135	Dodge	Sprinter 2500	2007-2009	Delantero
		Sprinter 3500	2007-2009	Delantero
	Mercedes-Benz	Sprinter 2500	2010-2015	Delantero
		Sprinter 3500	2010-2015	Delantero
902137	Chevrolet	Sonic	2012-2020	Delantero
		Spark	2013-2015	Delantero
902138	Nissan	March	2015-2017	Delantero
		Versa Note	2014-2019	Delantero
		Note	2014-2017	Delantero
		Versa	2012-2022	Delantero
		Micra	2015-2017	Delantero

### KIT DE CONVERSIÓN

90029C	Dodge	Charger	2006-2022	Trasero
		Magnum	2005-2008	Trasero



## ÍNDICE POR MODELO

MODELO	TIPO	MARCA	PÁG.
2	Auto	MAZDA	99
3	Auto	MAZDA	99
4 Runner	SUV	TOYOTA	123
5	Auto	MAZDA	99
6	Auto	MAZDA	99
6i	Auto	MAZDA	100
6S	Auto	MAZDA	100
9-2x	Auto	SAAB	119
9-3	Auto	SAAB	119
9-5	Auto	SAAB	119
128	Auto	BMW	24
135	Auto	BMW	24
200	Auto	CHRYSLER	49
206	Auto	PEUGEOT	114
207	Auto	PEUGEOT	114
300, 300C y 300M	Auto	CHRYSLER	49
300ZX	Auto	NISSAN	105
306	Auto	PEUGEOT	114
307	Auto	PEUGEOT	114
323i	Auto	BMW	25
325i	Auto	BMW	25
328i (E90)	Auto	BMW	25
330i	Auto	BMW	26
335i (E90, 92, 93)	Auto	BMW	26
350 Z	Auto	NISSAN	105
400	Auto	DODGE	53
500L	Auto	FIAT	63
525i	Auto	BMW	26
525iT	Auto	BMW	27
528i	Auto	BMW	27
528iT	Auto	BMW	27
530i	Auto	BMW	27
535i	Auto	BMW	27
540i	Auto	BMW	28
540iT	Auto	BMW	27
545i	Auto	BMW	28
550i	Auto	BMW	28
600	Auto	DODGE	53
626 (Cronos)	Auto	MAZDA	100
645Ci	Auto	BMW	28
700	Auto	RAM	117
740i, 740iL	Auto	BMW	28
1000, 3000	Pickup	DINA	53
A1	Auto	AUDI	24
A3	Auto	AUDI	24

MODELO	TIPO	MARCA	PÁG.
A4	Auto	AUDI	24
A6	Auto	AUDI	24
Acadia	SUV	GMC	78
Acclaim	Auto	PLYMOUTH	114
Accord	Auto	HONDA	83
Accord Crosstour	Auto	HONDA	84
Aerio	Auto	SUZUKI	123
Aerostar (Mini) Van	Van	FORD	63
Alhambra	Van	SEAT	119
Almera	Auto	NISSAN	105
Altea	Auto	SEAT	119
Alfima	Auto	NISSAN	105
Amanti	Auto	KIA	94
Amarok	Pickup	VOLKSWAGEN	133
American	Auto	AMERICAN MOTORS (RAMBLER)	23
Amigo	SUV	ISUZU	91
AMX	Auto	AMERICAN MOTORS (RAMBLER)	23
Aprío	Auto	NISSAN	106
Aries	Auto	DODGE	53
Armada	SUV	NISSAN	106
Aspen	Auto	DODGE	53
Astra	Auto	CHEVROLET	32
Astro (Mini Van)	Van	CHEVROLET	32
Atlantic	Auto	VOLKSWAGEN	133
Atos	Auto	CHRYSLER	49
ATS	Auto	CADILLAC	30
Attitude	Auto	DODGE	53
Avalanche	SUV	CHEVROLET	32
Avalon	Auto	TOYOTA	123
Avenger	Auto	DODGE	53
Aveo	Auto	CHEVROLET	32
Aviator	SUV	LINCOLN	97
Azera	Auto	HYUNDAI	88
Aztek AWD	Pickup	PONTIAC	115
B9 Tribeca	SUV	SUBARU	120
Barracuda	Auto	PLYMOUTH	114
Beat	Auto	CHEVROLET	32
Beetle	Auto	VOLKSWAGEN	133
Beretta	Auto	CHEVROLET	32
Blazer	SUV	CHEVROLET	32
Bonneville	Auto	PONTIAC	115
Bora	Auto	VOLKSWAGEN	133
Brasilia	Auto	VOLKSWAGEN	134
Bronco	SUV	FORD	63



# ÍNDICE POR MODELO

MODELO	TIPO	MARCA	PÁG.
C70	Auto	VOLVO	138
C-Max	Auto	FORD	64
Cabrio	Auto	VOLKSWAGEN	134
Cabriolet	Auto	VOLKSWAGEN	134
Caddy	Van	VOLKSWAGEN	134
Cadenza	Auto	KIA	94
Calais	Auto	OLDSMOBILE	113
Caliber	SUV	DODGE	54
Camaro	Auto	CHEVROLET	33
Camry	Auto	TOYOTA	124
Canyon Pickup	Pickup	GMC	78
Capri y Capri II	Auto	MERCURY	102
Caprice	Auto	CHEVROLET	33
Captiva	SUV	CHEVROLET	34
Captiva Sport	SUV	CHEVROLET	33
Captur	SUV	RENAULT	118
Caravan y Grand Caravan	Van	DODGE	54
Caravelle	Auto	PLYMOUTH	114
Caribe	Auto	VOLKSWAGEN	134
Catera	Auto	CADILLAC	30
Cavalier	Auto	CHEVROLET	34
CC	Auto	VOLKSWAGEN	134
Celebrity	Auto	CHEVROLET	34
Century	Auto	BUICK	29
Challenger	Auto	DODGE	55
Charger	Auto	DODGE	55
Cherokee	SUV	JEEP	92
Chevelle	Auto	CHEVROLET	34
Chevy Nova	Auto	CHEVROLET	34
Chevy Pickup	Pickup	CHEVROLET	34
Chevy, Chevy Joy, Pop y Swing	Auto	CHEVROLET	34
Cimarron	Auto	CADILLAC	30
Cirrus	Auto	CHRYSLER	49
Citation	Auto	CHEVROLET	34
City	Van	HONDA	84
City Express	Van	CHEVROLET	34
Civic	Auto	HONDA	84
CJ	SUV	JEEP	92
Clase C	Auto	MERCEDES BENZ	101
Clase E	Auto	MERCEDES BENZ	101
Clase M (SUV)	SUV	MERCEDES BENZ	102
Clase SLK	Auto	MERCEDES BENZ	102
Clio	Auto	RENAULT	118
Club Wagon	Van	FORD	78

MODELO	TIPO	MARCA	PÁG.
Colorado Pickup	Pickup	CHEVROLET	34
Commander	SUV	JEEP	92
Compass	SUV	JEEP	92
Concorde	Auto	CHRYSLER	50
Contour	Auto	FORD	64
Cooper	Auto	MINI	103
Cordoba	Auto	SEAT	119
Corolla	Auto	TOYOTA	125
Coronet	Auto	DODGE	56
Corsa	Auto	CHEVROLET	35
Corsica	Auto	CHEVROLET	35
Corvette	Auto	CHEVROLET	35
Cougar	Auto	MERCURY	102
Courier Pickup	Pickup	FORD	64
CR-V	SUV	HONDA	85
Crafter	Van	VOLKSWAGEN	134
Crossfox	SUV	VOLKSWAGEN	134
Crosstour	Auto	HONDA	86
Crosstrek	SUV	SUBARU	120
Crown Victoria	Auto	FORD	64
Cruze	Auto	CHEVROLET	35
CTS	Auto	CADILLAC	31
Cube	Auto	NISSAN	106
Cutlass	Auto	OLDSMOBILE	113
Cutlass Ciera	Auto	OLDSMOBILE	113
Cutlass Supreme	Auto	OLDSMOBILE	113
CX-5	SUV	MAZDA	100
CX-7	SUV	MAZDA	100
CX-9	SUV	MAZDA	101
Dakota	Pickup	DODGE	56
Dart	Auto	DODGE	56
Datsun	Auto	NISSAN	106
Daytona	Auto	DODGE	57
Derby	Auto	VOLKSWAGEN	134
Derby Van	Van	VOLKSWAGEN	134
DeVille	Auto	CADILLAC	31
Diplomat	Auto	DODGE	57
Discovery	SUV	LAND ROVER	96
Durango	SUV	DODGE	57
Duster	Auto	PLYMOUTH	114,118
Duster	Auto	RENAULT	114,118
Dynasty	Auto	CHRYSLER	50
Eclipse	Auto	MITSUBISHI	103
EcoSport	SUV	FORD	64
Edge	SUV	FORD	64



## ÍNDICE POR MODELO

MODELO	TIPO	MARCA	PÁG.
Eighty-Eight (88)	Auto	OLDSMOBILE	113
Elantra	Auto	HYUNDAI	88
Eldorado	Auto	CADILLAC	31
Element	Auto	HONDA	86
Enclave	SUV	BUICK	29
Encore	SUV	BUICK	29
Entourage	Van	HYUNDAI	88
Envision	SUV	BUICK	29
Envoy	SUV	GMC	79
Eos	Auto	VOLKSWAGEN	134
Equinox	SUV	CHEVROLET	36
ES330	Auto	LEXUS	97
Escalade	SUV	CADILLAC	31
Escape	SUV	FORD	65
Escort	Auto	FORD	65
Eurosport	Auto	OLDSMOBILE	113
Eurovan TDI	Van	VOLKSWAGEN	134
EX35	SUV	INFINITI	90
Excursion	SUV	FORD	65
Expedition	SUV	FORD	65
Explorer	SUV	FORD	66
Fairline y Fairline 500	Auto	FORD	67
Falcon	Auto	FORD	67
Fiesta	Auto	FORD	67
Fiesta Ikon	Auto	FORD	67
Firebird	Auto	PONTIAC	115
Fit	Auto	HONDA	86
Five Hundred	Auto	FORD	67
FJ Cruiser	SUV	TOYOTA	126
Flex	Auto	FORD	68
Focus	Auto	FORD	68
Forester	SUV	SUBARU	120
Forte	Auto	KIA	94
Freestar (Mini Van)	Van	FORD	69
Freestyle	Van	FORD	69
Frontier Pickup	Pickup	NISSAN	107
Fusion	Auto	FORD	69
FX37	SUV	INFINITI	90
FX50	SUV	INFINITI	90
G3	Auto	PONTIAC	115
G5	Auto	PONTIAC	115
G6	Auto	PONTIAC	115
G20	Auto	INFINITI	90
G25	Auto	INFINITI	90
G35	Auto	INFINITI	90

MODELO	TIPO	MARCA	PÁG.
G37	Auto	INFINITI	90
Galant	Auto	MITSUBISHI	104
Galaxie	Auto	FORD	69
Ghia	Auto	FORD	69
Gol	Auto	VOLKSWAGEN	134
Gol Sedán	Auto	VOLKSWAGEN	135
Golf A2	Auto	VOLKSWAGEN	135
Golf A3	Auto	VOLKSWAGEN	135
Golf A4	Auto	VOLKSWAGEN	135
Golf SportWagen	Auto	VOLKSWAGEN	135
Grand Am	Auto	PONTIAC	116
Grand Cherokee	SUV	JEEP	92
Grand Marquis	Auto	FORD	70, 102
Grand Marquis	Auto	MERCURY	70, 102
Grand Prix	Auto	PONTIAC	116
Grand Vitara	SUV	SUZUKI	123
Gremlin	Auto	AMERICAN MOTORS (RAMBLER)	23
GTi	Auto	VOLKSWAGEN	135
GTO	Auto	PONTIAC	116
GX470	SUV	LEXUS	97
H100	Chasis	HYUNDAI	88
H-100	Van	CHRYSLER	50
HHR	SUV	CHEVROLET	36
Hiace	Van	TOYOTA	126
Highlander	SUV	TOYOTA	126
Hilux	Pickup	TOYOTA	127
Hummer	SUV	HUMMER	87
i10	Auto	DODGE	57
I30, I35	Auto	INFINITI	91
Ibiza	Auto	SEAT	119
Ikon	Auto	FORD	70
Impala	Auto	CHEVROLET	36
Impala Limited	Auto	CHEVROLET	37
Impreza	Auto	SUBARU	121
Insight	Auto	HONDA	87
Integra	Auto	ACURA	23
Intrepid	Auto	DODGE	57
Intrigue	Auto	OLDSMOBILE	113
Ion	Auto	SATURN	119
Javelin	Auto	AMERICAN MOTORS (RAMBLER)	23
Jetta	Auto	VOLKSWAGEN	135
Jetta A2	Auto	VOLKSWAGEN	136
Jetta A3	Auto	VOLKSWAGEN	136
Jetta A4	Auto	VOLKSWAGEN	136





## ÍNDICE POR MODELO

MODELO	TIPO	MARCA	PÁG.
Jetta Clasico	Auto	VOLKSWAGEN	135
Journey	Van	DODGE	58
Juke	SUV	NISSAN	107
KA	Auto	FORD	70
Kangoo	Van	RENAULT	118
Kangoo Express	Van	RENAULT	118
Kicks	SUV	NISSAN	107
Koleos	SUV	RENAULT	118
LaCrosse	Auto	BUICK	29
Laguna	Auto	RENAULT	118
Lancer	Auto	DODGE	58, 104
Lancer	Auto	MITSUBISHI	58, 104
Land Cruiser	SUV	TOYOTA	127
Le Mans	Auto	PONTIAC	116
LeBaron	Auto	CHRYSLER	50
Legacy	Auto	SUBARU	122
León	Auto	SEAT	119
LHS	Auto	CHRYSLER	50
Liberty	SUV	JEEP	93
LLV	Van	CHEVROLET	37, 79
LLV	Van	GMC	37, 79
Logan	Auto	RENAULT	118
LS	Auto	LINCOLN	97
LTD	Auto	FORD	70
LTD II	Auto	FORD	70
Lucino	Auto	NISSAN	107
Lumina	Auto	CHEVROLET	37
Lupo	Auto	VOLKSWAGEN	136
Luv Pickup	Pickup	CHEVROLET	37
M35	Auto	INFINITI	91
M45	Auto	INFINITI	91
Magentis	Auto	KIA	94
Magnum	Auto	DODGE	58
Malibu	Auto	CHEVROLET	38
March	Auto	NISSAN	107
Mariner	SUV	MERCURY	102
Matiz	Auto	CHEVROLET	38, 116
Matiz	Auto	PONTIAC	38, 116
Matrix	Auto	TOYOTA	128
Maverick	Auto	FORD	70
Maxima	Auto	NISSAN	107
MDX	SUV	ACURA	23
Megane, Megane II	Auto	RENAULT	118
Meriva	Auto	CHEVROLET	38
Micra	Auto	NISSAN	108

MODELO	TIPO	MARCA	PÁG.
Mirage	Auto	MITSUBISHI	105
MKC	SUV	LINCOLN	97
MKS	Auto	LINCOLN	98
MKT	SUV	LINCOLN	98
MKX	SUV	LINCOLN	98
MKZ	Auto	LINCOLN	98
Mónaco	Auto	DODGE	58
Mondeo	Auto	FORD	70
Monte Carlo	Auto	CHEVROLET	38
Montero	SUV	MITSUBISHI	105
Monza	Auto	CHEVROLET	38
MR2 Spyder	Auto	TOYOTA	128
Murano	SUV	NISSAN	108
Mustang	Auto	FORD	70
MX-5 Miata	Auto	MAZDA	101
Mystique	Auto	FORD	70, 102
Mystique	Auto	MERCURY	70, 102
Navigator	SUV	LINCOLN	98
Neón	Auto	DODGE	58
New Yorker y Fifth Avenue	Auto	CHRYSLER	51
Nitro	SUV	DODGE	58
Note	Auto	NISSAN	108
NP300	Pickup	NISSAN	109
NP300 Frontier	Pickup	NISSAN	109
Nuevo Gol	Auto	VOLKSWAGEN	136
Nuevo Ibiza	Auto	SEAT	119
NV200	Van	NISSAN	109
Odyssey (Mini Van)	Van	HONDA	87
Omega	Auto	OLDSMOBILE	113
Optima	Auto	KIA	94
Optra	Auto	CHEVROLET	39
Oroch	Pickup	RENAULT	118
Outback	SUV	SUBARU	122
Outlander	SUV	MITSUBISHI	105
Pacifica	SUV	CHRYSLER	51
Palio	Auto	FIAT	63
Partner	Van	PEUGEOT	114
Passat	Auto	VOLKSWAGEN	136
Passat CC	Auto	VOLKSWAGEN	136
Pathfinder	SUV	NISSAN	109
Patriot	SUV	JEEP	93
Pickup	Pickup	ISUZU	91, 109
Pickup	Pickup	NISSAN	91, 109
Pickup 720	Pickup	NISSAN	109
Pickup K y V	Pickup	CHEVROLET	39



## ÍNDICE POR MODELO

MODELO	TIPO	MARCA	PÁG.
Pickup B2600	Pickup	MAZDA	101
Pickup C y R	Pickup	CHEVROLET	39
Pickup Cheyenne	Pickup	CHEVROLET	39
Pickup Compact	Pickup	TOYOTA	128
Pickup D-21	Pickup	NISSAN	109
Pickup D y W	Pickup	DODGE	61
Pickup F650 y F750	Pickup	FORD	76
Pickup Mark LT	Pickup	LINCOLN	98
Pickup Ram 1500	Pickup	DODGE	58
Pickup Ram 2500	Pickup	DODGE	59
Pickup Ram 3500	Pickup	DODGE	60
Pickup Ram 4500	Pickup	DODGE	61
Pickup Ram 5500	Pickup	DODGE	61
Pickup S	Pickup	JEEP	93
Pickup Serie F-100, F-150, Lobo	Pickup	FORD	71
Pickup Serie F-250	Pickup	FORD	72
Pickup Serie F-350	Pickup	FORD	73
Pickup Serie F-450	Pickup	FORD	75
Pickup Serie F-550	Pickup	FORD	75
Pickup Series C, R, K y V	Pickup	GMC	81
Pickup Sierra 1500	Pickup	GMC	79
Pickup Sierra 2500	Pickup	GMC	81
Pickup Sierra 3500	Pickup	GMC	81
Pickup Silverado	Pickup	CHEVROLET	40
Pickup T100	Pickup	TOYOTA	128
Pilot	SUV	HONDA	87
Platina	Auto	NISSAN	109
Pointer	Auto	VOLKSWAGEN	136
Pointer Pickup	Pickup	VOLKSWAGEN	136
Polo	Auto	VOLKSWAGEN	136
Previa (Van)	Van	TOYOTA	129
Prius	Auto	TOYOTA	129
Prius C	Auto	TOYOTA	129
Prius V	Auto	TOYOTA	129
Probe	Auto	FORD	76
PT Cruiser	SUV	CHRYSLER	51
Q45	Auto	INFINITI	91
Quest (Mini Van)	Van	NISSAN	109
QX56	SUV	INFINITI	91
QX70	SUV	INFINITI	91
QX80	SUV	INFINITI	91
Ram Cargo Caravan (C/V)	Van	DODGE	62
Ramcharger	SUV	DODGE	62
Ranchero	Auto	FORD	76

MODELO	TIPO	MARCA	PÁG.
Ranger	Pickup	FORD	76
RAV4	SUV	TOYOTA	129
Regal	Auto	BUICK	30
Reliant	Auto	PLYMOUTH	114
Renegade	Auto	JEEP	93
Ridgeline	SUV	HONDA	87
Rio	Auto	KIA	95
Roadrunner	Auto	PLYMOUTH	115
Rodeo	SUV	ISUZU	91
Rogue	SUV	NISSAN	110
Rondo	Auto	KIA	95
Routan	SUV	VOLKSWAGEN	137
RX330	SUV	LEXUS	97
RX350	SUV	LEXUS	97
RX400H	SUV	LEXUS	97
RX-8	Auto	MAZDA	101
S	Auto	JAGUAR	92
S40	Auto	VOLVO	137
S60	Auto	VOLVO	138
S80	Auto	VOLVO	138
S-10	Pickup	CHEVROLET	43
Sable	Auto	MERCURY	103
Safari	Auto	VOLKSWAGEN	137
Sandero	SUV	RENAULT	118
Santa Fe	SUV	HYUNDAI	88
Savana	Van	GMC	83
Saveiro	Pickup	VOLKSWAGEN	137
Scala	Auto	RENAULT	119
Scenic	Auto	RENAULT	119
Sebring	Auto	CHRYSLER	51, 62
Sebring	Auto	DODGE	51, 62
Sedán	Auto	VOLKSWAGEN	137
Sedona	Van	KIA	95
Sentra	Auto	NISSAN	110
Sequoia	SUV	TOYOTA	130
Serie 1500	Pickup	RAM	117
Serie 2500	Pickup	RAM	117
Serie Promaster	Van	RAM	117
Seville	Auto	CADILLAC	31
Shadow	Auto	DODGE	62
Sharan	Van	VOLKSWAGEN	137
Sienna	Van	TOYOTA	130
Silhouette	Van	OLDSMOBILE	114
Solara	Auto	TOYOTA	132
Sonata	Auto	HYUNDAI	89



# ÍNDICE POR MODELO

MODELO	TIPO	MARCA	PÁG.
Sonic	Auto	CHEVROLET	43
Sonoma 2WD	Pickup	GMC	83
Sonora	SUV	CHEVROLET	43
Sorento	Van	KIA	95
Soul	Auto	KIA	96
Spark	Auto	CHEVROLET	43
Spark Classic	Auto	CHEVROLET	43
Spectra	Auto	KIA	96
Spectra 5	Auto	KIA	96
Spirit	Auto	DODGE	62
Sportage	SUV	KIA	96
SportVan	Van	VOLKSWAGEN	137
SRX	SUV	CADILLAC	31
Stanza	Auto	NISSAN	111
Stepway	Auto	RENAULT	119
Strada	Pickup	FIAT	63
Stratus	Auto	CHRYSLER	51, 62
Stratus	Auto	DODGE	51, 62
STS	Auto	CADILLAC	31
Suburban	SUV	CHEVROLET	43
Sundance	Auto	PLYMOUTH	115
Sunfire	SUV	PONTIAC	116
Swift	Auto	SUZUKI	123
SX4	Auto	SUZUKI	123
Tacoma	Pickup	TOYOTA	132
Tahoe	SUV	CHEVROLET	45
Taurus	Auto	FORD	76
Taurus X	Auto	FORD	76
tC	Auto	SCION	120
Tempo	Auto	FORD	77
Tercel	Auto	TOYOTA	132
Terrain	SUV	GMC	83
Thunderbird	Auto	FORD	77
Tiguan	SUV	VOLKSWAGEN	137
Tiida	Auto	NISSAN	111
Titan Pickup	Pickup	NISSAN	111
TL	Auto	ACURA	23
TLX	Auto	ACURA	23
Toledo	Auto	SEAT	120
Topaz	Auto	FORD	77, 103
Topaz	Auto	MERCURY	77, 103
Torino y Gran Torino	Auto	FORD	77
Tornado	Pickup	CHEVROLET	46
Torrent	SUV	PONTIAC	116
Touareg	SUV	VOLKSWAGEN	137

MODELO	TIPO	MARCA	PÁG.
Town & Country	Van	CHRYSLER	51
Town Car	Auto	LINCOLN	99
Tracker	SUV	CHEVROLET	46
Trailblazer	SUV	CHEVROLET	46
Transit	Van	FORD	77
Transporter	Van	VOLKSWAGEN	137
Traverse	SUV	CHEVROLET	47
Trax	SUV	CHEVROLET	45
Tribeca	SUV	SUBARU	122
Trooper	SUV	ISUZU	91
Tsubame	Auto	NISSAN	111
Tsuru	Auto	NISSAN	112
TSX	Auto	ACURA	23
TT	Auto	AUDI	24
Tucson	SUV	HYUNDAI	89
Tundra	Pickup	TOYOTA	132
Uplander	Van	CHEVROLET	47
Urvan	Van	NISSAN	112
V40	Auto	VOLVO	138
V50	Auto	VOLVO	138
V70	Auto	VOLVO	138
Van 1500 Express, Savana, Modelos G y P	Van	CHEVROLET	47
Van Caravelle	Van	VOLKSWAGEN	137
Van Cargo Van	Van	CHEVROLET	48
Van Combi	Van	VOLKSWAGEN	137
Van Econoline	Van	FORD	78
Van Eurovan	Van	VOLKSWAGEN	137
Van Express Cargo	Van	CHEVROLET	48
Van Ichi Van	Van	NISSAN	112
Van Panel	Van	VOLKSWAGEN	137
Van Ram	Van	DODGE	63
Van Serie E	Van	FORD	78
Van Sprinter	Van	DODGE	63, 102
Van Sprinter	Van	MERCEDES BENZ	63, 102
Van Urvan	Van	NISSAN	112
Van Vanagon	Van	VOLKSWAGEN	137
Van Vanette Panel	Van	NISSAN	112
Veloster	Auto	HYUNDAI	89
Vento	Van	VOLKSWAGEN	137
Venture (Mini Van) AWD	Van	CHEVROLET	48
Venza	SUV	TOYOTA	133
Veracruz	SUV	HYUNDAI	90
Verano	Auto	BUICK	30
Verna	Auto	CHRYSLER	52



## ÍNDICE POR MODELO

MODELO	TIPO	MARCA	PÁG.
Versa	Auto	NISSAN	112
Vibe	Auto	PONTIAC	116
Villager	Van	MERCURY	103
Volare	Auto	PLYMOUTH	115
Voyager y Grand Voyager	Van	CHRYSLER	52
Wagoneer (Grand Wagoneer)	SUV	JEEP	93
Windstar (Mini Van)	Van	FORD	78
Wrangler	SUV	JEEP	94
X	Auto	JAGUAR	92
X3	SUV	BMW	28
X5	SUV	BMW	28
X6	SUV	BMW	28
X-Trail	SUV	NISSAN	113
xB	Auto	SCION	120
XC60	Auto	VOLVO	138
xD	Auto	SCION	120
Xterra	SUV	NISSAN	112
XV Crosstrek	SUV	SUBARU	123
Yaris	Auto	TOYOTA	133
Yukon	SUV	GMC	83
Z3	Auto	BMW	28
Z4	Auto	BMW	28
Zafira	Van	CHEVROLET	49
Zephyr	Auto	LINCOLN	99, 103
Zephyr	Auto	MERCURY	99, 103



## SIMBOLOGÍA

n	Nuevo número de parte
g	Número de parte bajo pedido especial
.	Número de parte hasta agotar existencias
R	Monro-Matic Plus Reforzado
911138 37138	Letras grises indican reemplazo
EL	Unidad Premium que son considerados con vástago de extensión lenta.
H	Unidad Premium hidráulica, el vástago no se extenderá por sí mismo ya que este número de parte no contiene gas.
0	Este número de parte incluye: Base de amortiguador, cubre polvo y tope de rebote
1	Puede que se requiera el juego de piezas AK27 para reemplazar los tornillos y las tuercas originales del montaje inferior si están dañados o si no es posible reutilizarlos.
2	Puede que se requiera el juego de piezas AK28 para reemplazar los tornillos y las tuercas originales del montaje inferior si están dañados o si no es posible reutilizarlos.
3	Puede que se requiera el juego de piezas AK30 para reemplazar los tornillos y las tuercas originales del montaje inferior si están dañados o si no es posible reutilizarlos.
4	Se requiere el juego de adaptadores AK16 para reemplazar amortiguadores neumáticos ajustables en los vehículos equipados con un sistema de nivelación automática.
7	Puede que se requiera el juego de piezas AK23 para reemplazar los tornillos y las tuercas originales del montaje inferior si están dañados o si no es posible reutilizarlos.
8	El compresor de resorte NO ES necesario para reemplazar los struts en este vehículo.
10	Algunos modelos con suspensión de 4", pueden necesitar el número RS6640 para evitar vibraciones.
11	Este es un strut de aire
12	Puede que se requiera el juego de piezas AK77 para reemplazar los tornillos y las tuercas originales del montaje inferior si están dañados o si no es posible reutilizarlos.
15	Excepto en los modelos equipados con una suspensión de resorte neumática trasera.
21	Puede que se requiera el juego de piezas AK37 para reemplazar los tornillos y las tuercas originales del montaje inferior si están dañados o si no es posible reutilizarlos.
22	Se requiere el juego de piezas AK38 para instalar esta unidad.
23	Las monturas del amortiguador son ligeramente más estrechas que los tornillos de montura del coche, lubricación y un esfuerzo es necesario para instalar la unidad.
24	Esto es solo el balero, no es la base de amortiguador completa.
25	Puede que se requiera el juego de piezas AK42 para reemplazar los tornillos y las tuercas originales del montaje inferior si están dañados o si no es posible reutilizarlos.
26	Puede que se requiera el juego de piezas AK41 para reemplazar los tornillos y las tuercas originales del montaje inferior si están dañados o si no es posible reutilizarlos.
29	Este juego de montaje contiene el juego de cubre polvo 63975.
31	Puede que se requiera el juego de piezas AK43 para reemplazar los tornillos y las tuercas originales del montaje inferior si están dañados o si no es posible reutilizarlos.
41	Puede que se requiera el juego de piezas AK50 para reemplazar los tornillos y las tuercas originales del montaje inferior si están dañados o si no es posible reutilizarlos.
42	Puede que se requiera el juego de piezas AK51 para reemplazar los tornillos y las tuercas originales del montaje inferior si están dañados o si no es posible reutilizarlos.
43	Puede que se requiera el juego de piezas AK52 para reemplazar los tornillos y las tuercas originales del montaje inferior si están dañados o si no es posible reutilizarlos.
44	Puede que se requiera el juego de piezas AK53 para reemplazar los tornillos y las tuercas originales del montaje inferior si están dañados o si no es posible reutilizarlos.
46	Se requiere el juego de piezas AK79 para instalar un PAR de estas unidades en esta aplicación.
49	La herramienta especial AK73 está disponible para retirar e instalar esta base de amortiguador.
54	Puede que se requiera el juego de piezas AK68 para reemplazar los tornillos y las tuercas originales del montaje inferior si están dañados o si no es posible reutilizarlos.
56	El balero 901947 está disponible cuando se necesite reemplazar el balero solamente.
57	Se necesitan herramientas especiales para instalar esta unidad.
58	Puede que se requiera el juego de piezas AK58 para reemplazar los tornillos y las tuercas originales del montaje inferior si están dañados o si no es posible reutilizarlos o si NO SON de diseño Cam.
60	Aplicación especial : Este modelo NO necesita una capa debido a los espacios libres.
63	Reemplaza el conjunto del strut que no tiene un corchete de asiento de resorte inferior.
64	Se requiere el juego de adaptadores AK14 para reemplazar el amortiguador neumático ajustable en los vehículos equipados con un sistema de nivelación automática.
66	Procedures for replacing Electronic Adjustable Suspension with non-adjustable product see Appendix A.
70	El balero 901902 está disponible cuando se necesite reemplazar el balero solamente.
71	El balero 901901 está disponible cuando se necesite reemplazar el balero solamente.
72	El balero 901928 está disponible cuando se necesite reemplazar el balero solamente.
77	Se requiere el juego de piezas AK29 para instalar esta unidad cuando es necesario adaptar struts neumáticos a una suspensión no neumática.
89	Puede que se requiera el juego de piezas AK71 para reemplazar los tornillos y las tuercas originales del montaje inferior si están dañados o si no es posible reutilizarlos.
90	Se requiere el juego de piezas AK75 para instalar esta unidad en vehículos equipados con frenos ABS.
97	Puede ser que requiera el juego bases y cubre polvo.
106	El kit del adaptador AK-29 se requiere para instalar esta unidad al adaptar amortiguadores de choque ajustables del aire a los vehículos sin sistema de nivelación posterior.
108	Solo utilice con Struts Monroe
115	Modelos con 31/4" espaciamento entre pernos de montaje más bajos.
116	En la placa de rodamiento de segundo diseño, la tuerca de la vara y el espaciador de E.O. son integradas en un solo componente.
117	Se requiere el juego AK28 para instalar en vehículos con barra de torsión trasera.
122	Esta unidad es un amortiguador convencional NO electrónico
130	Excluye el uso con un brazo de soporte para torre de strut
148	Solo utilice con unidades de suspensión de equipo original.
152	Este amortiguador tiene un asiento de resorte
195	Use solo amortiguadores de Equipo Original ó Número de Parte 5796 con Belgina como país de origen.
200	Requiere de 1 Kit por vehículo.
215	Base de amortiguador y Ensamblaje de balero/Asiento de Resorte (2 piezas)
216	Ensamblaje de base de amortiguador/balero/asiento de resorte (1 pieza)
223	No funciona con EO #31331139437
269	Se requiere kit de montaje 903936 para instalar strut
270	Se requiere kit de montaje 903935 para instalar strut
313	No se utilice con espaciadores del mercado de repuestos.
316	Requiere un soporte adaptador de Rancho
317	Reemplaza número de parte OEM 52014061AA
318	Reemplaza OE #(s) 52014077AB

**MONROE**  
AMORTIGUADORES



# APLICACIONES

## AUTO Y CAMIONETA

### CATÁLOGO 2023



## APLICACIONES



### ACURA — Integra

1994-01	Todos — Exc. Series tipo R	—	—	901940 <sup>®</sup> 63628	901940 <sup>®</sup> 63628	—	—	—	—
---------	----------------------------	---	---	------------------------------	------------------------------	---	---	---	---

### ACURA — MDX

2007-13	Todos — Exc. c/ Susp. Elect. Autoajustable								
	Derecho	72433	37309	907983	—	—	—	—	—
	Izquierdo	72434	37309	907983	—	—	—	—	—

### ACURA — TL

2009-14	Todos								
	Derecho	72693 ■	72692	901940 <sup>®</sup>	901940 <sup>®</sup>	—	—	—	—
	Izquierdo	—	72692	901940 <sup>®</sup>	901940 <sup>®</sup>	—	—	—	—
	Plato de Montaje	—	—	902034 ■	—	—	—	—	—
	Aislador de Resorte Superior	—	—	909922 63628	—	—	—	—	—
2006-08	Todos	72322	—	901940 <sup>®</sup>	—	—	801372	—	—
	Plato de Montaje	—	—	902050 ● 63628	—	—	—	—	—
2004-05	Todos	72322	—	901940 <sup>®</sup>	901940 <sup>®</sup>	—	801372	—	—
	Plato de Montaje	—	—	902050 ● 63628	— 63629	—	—	—	—

### ACURA — TLX

2015-20	Todos								
	Derecho	72970	—	—	—	—	—	—	—
	Izquierdo	72971	—	—	—	—	—	—	—
				63638					

### ACURA — TSX

2009-14	Todos								
	Derecho	72770 ■	72692	901940 <sup>®</sup>	901940 <sup>®</sup>	—	—	—	—
	Izquierdo	—	72692	901940 <sup>®</sup>	901940 <sup>®</sup>	—	—	—	—
	Plato de Montaje Derecho	—	—	909918	—	—	—	—	—
	Plato de Montaje Izquierdo	—	—	909917	—	—	—	—	—
	Aislador de Resorte Superior	—	—	909922 63628	— 63628	—	—	—	—
2004-08	Todos	72322	72324 ■	901940 <sup>®</sup> 63628	901940 <sup>®</sup> 63629	—	—	—	—

### AMERICAN MOTORS (RAMBLER) — American

1964-69	Todos	5819 ■	5818	—	—	—	—	—	—
---------	-------	--------	------	---	---	---	---	---	---

### AMERICAN MOTORS (RAMBLER) — AMX

1978-80	Todos	5809	—	—	—	—	—	—	—
1971-74	Todos	5809	5803	—	—	—	—	—	—

### AMERICAN MOTORS (RAMBLER) — Gremlin

1971-78	Todos — Exc. 1977 c/ Motor de 4 Cil.	5809	—	—	—	—	—	—	—
---------	--------------------------------------	------	---	---	---	---	---	---	---

### AMERICAN MOTORS (RAMBLER) — Javelin

1970-74	Todos	5809	5803	—	—	—	—	—	—
---------	-------	------	------	---	---	---	---	---	---

● Nuevo número de parte

■ Número de parte bajo pedido especial

® Este número de pieza es una marca registrada de Tenneco y no se puede usar ni reproducir sin permiso.

## APLICACIONES

	<b>OESpectrum</b>	<b>GAS-MAGNUM®</b>		<b>MONRO-MATIC PLUS®</b>		<b>ROADMATIC</b>	
	<b>Reflex</b>	BASES DE AMORTIGUADOR CUBREPOLVO		MONRO-MATIC® HIDRÁULICO		LOAD ADJUSTING® MAX-AIR®	

### AUDI — A1

2011-20	Todos	71058	5507	—	—	—	—	—	—
---------	-------	-------	------	---	---	---	---	---	---

### AUDI — A3

2005-13	Todos — Exc. c/ Susp. Electrónica c/ Tope de rebote redondo de 50 mm de diámetro exterior	72312	5611	907949	63636	—	—	400032●	250011
		—	—	—	907947	—	—	—	—
1998-04	Hatchback	71525	5984	904905	904910	—	—	400525	250984
				63631					

### AUDI — A4

2010-16	Todos	71331	71332	904992	904965■	—	—	—	—
2001-09	Cabriolet (Convertible)	71331	71332	904992	904965■	—	—	—	—
Nov 2000-08	Quattro Sedán y Avant Wagon — Inc. Suspensión Deportiva	71331	71332	904992	904965■	—	—	—	—
Feb 1999-	Sedán y Avant Wagon — Inc. Susp. Deportiva	—	—	904992	—	—	—	—	—
Nov 00	Sedán y Avant Wagon Inc. c/ Susp. Deportiva — Exc. Quattro	—	—	904992	—	—	—	—	—
1997-99	Todos	71331	71332	904992	904965■	—	—	—	—

### AUDI — A6

2012-18	Todos	—	—	904992	—	—	—	—	—
2005-11	Sedán y Wagon — Exc. c/ Susp. de Aire o Sport	—	—	—	904965■	—	—	—	—
May 2000-04	Quattro — Sedán y Wagon	71335	71334	904992	—	—	—	—	—
	Sedán y Wagon — Exc. Quattro	71335	39102	904992	904909	—	—	—	—
Ene 1999-	Quattro — Sedán y Wagon	—	71334	904992	—	—	—	—	—
Abr 00	Sedán y Wagon — Exc. Quattro	—	39102	904992	904909	—	—	—	—

### AUDI — TT

2008-15	Todos	—	—	907949	—	—	—	—	—
2000-06	Todos — Exc. Sport y Quattro	—	5996■	904905	904910	—	—	—	—
	Quattro — Exc. c/ Suspensión Sport	—	—	904905	904910	—	—	—	—

### BMW — 128

2008-13	Convertible — Exc. c/ Susp. Deportiva								
	Derecho	72313	5616	903918	—	—	—	—	—
	Izquierdo	72314	5616	903918	—	—	—	—	—
	Convertible — c/ Susp. Deportiva								
	Derecho	72755	5681	903918	—	—	—	—	—
	Izquierdo	72756	5681	903918	—	—	—	—	—

### BMW — 135

2008-13	Convertible — Exc. c/ Susp. Deportiva								
	Derecho	72313	5616	903918	—	—	—	—	—
	Izquierdo	72314	5616	903918	—	—	—	—	—

● Nuevo número de parte

■ Número de parte bajo pedido especial





## APLICACIONES

		GAS-MAGNUM®		MONRO-MATIC PLUS®		ROADMATIC	
		BASES DE AMORTIGUADOR		MONRO-MATIC® HIDRÁULICO		LOAD ADJUSTING	
		CUBREPOLVO				MAX-AIR®	

### BMW — 135 (Cont.)

2008-13 (Cont.)	Convertible — c/ Susp. Deportiva								
	Derecho	72755	5681	903918	—	—	—	—	—
	Izquierdo	72756	5681	903918	—	—	—	—	—

### BMW — 323i

2007-10	Todos — c/ Susp. Deportiva								
	Derecho	72755	—	—	—	—	—	—	—
	Izquierdo	72756	—	—	—	—	—	—	—
				63631					
1999-00	Todos (E46) — Wagon								
	Derecho	71581	5998	903918	904966	—	—	—	—
	Izquierdo	—	5998	903918	904966	—	—	—	—

### BMW — 325i

2007-13	Todos (E90) — Exc. Susp. Deportiva								
	Derecho	72313	5616	903918	—	—	—	—	—
	Izquierdo	72314	5616	903918	—	—	—	—	—
	Aislador de Resorte Inferior	—	—	907967 ■	—	—	—	—	—
2006-13	Todos (E90) — Exc. Susp. Deportiva								
	Derecho	72313	5616	903918	—	—	—	—	—
	Izquierdo	72314	5616	903918	—	—	—	—	—
	Aislador de Resorte Inferior	—	—	907967 ■	—	—	—	—	—
2006	Todos (E90) Sedán — c/ Susp. Deportiva								
	Derecho	72755	5681	903918	—	—	—	—	—
	Izquierdo	72756	5681	903918	—	—	—	—	—
	Aislador de Resorte Inferior	—	—	907967 ■	—	—	—	—	—
2001-05	Todos (E46) — Sedán								
	Derecho	71581	5988	903918	904966	—	—	—	—
	Izquierdo	—	5988	903918	904966	—	—	—	—
	Asiento de Resorte Superior	—	—	907973 ■	—	—	—	—	—
				63631					
1995-97	Todos (E46) — Sedán								
	Derecho	—	5974 ■	902905	901965	—	—	—	—
	Izquierdo	—	5974 ■	902905	901965	—	—	—	—
				63638					

### BMW — 328i (E90)

2007-13	328i (E90) — Exc. Susp. Deportiva, Susp. Electronica y xDrive								
	Derecho	72313	5616	903918	—	—	—	—	—
	Izquierdo	72314	5616	903918	—	—	—	—	—
	Aislador de Resorte Inferior	—	—	907967 ■	—	—	—	—	—
	Aislador de Resorte Superior	—	—	—	907984	—	—	—	—
	328i (E90, 92, 93) — c/ Susp. Deportiva — Exc. c/ Susp. Electrónica y xDrive								
	Derecho	72755	5681	903918	—	—	—	—	—
	Izquierdo	72756	5681	903918	—	—	—	—	—
	Aislador de Resorte Inferior	—	—	907967 ■	—	—	—	—	—
	Montura Superior	—	—	—	907984	—	—	—	—

■ Número de parte bajo pedido especial



## APLICACIONES

	OESpectrum <i>Reflex</i>	GAS-MAGNUM®		MONRO-MATIC PLUS®		ROADMATIC LOAD ADJUSTING®	
		Bases de Amortiguador CUBREPOLVO		MONRO-MATIC® HIDRÁULICO		MAX-AIR®	

### BMW — 330i

2006-07	Todos (E90) — Exc. Susp. Deportiva								
	Derecho	72313	5616	903918	904966	—	—	—	—
	Izquierdo	72314	5616	903918	904966	—	—	—	—
2006	Todos (E90) Sedán —c/ Susp. Deportiva								
	Derecho	72755	5681	903918	904966	—	—	—	—
	Izquierdo	72756	5681	903918	904966	—	—	—	—
	Aislador de Resorte Inferior	—	—	907967■ 63631	—	—	—	—	—
2001-05	Todos (E46) — Sedán								
	Derecho	71581	5988	903918	904966	—	—	—	—
	Izquierdo	—	5988	903918 63631	904966	—	—	—	—

### BMW — 335i (E90, 92, 93)

2007-13	335i (E90, 92, 93) — c/ Susp. Deportiva — Exc. c/ susp. Electrónica y xDrive								
	Derecho	72755	5681	903918	—	—	—	—	—
	Izquierdo	72756	5681	903918	—	—	—	—	—
	Aislador de Resorte Inferior	—	—	907967■	—	—	—	—	—
	Montura Superior	—	—	—	907984	—	—	—	—
2007-15	335i (E90) — Exc. c/ Susp. Deportiva, Susp. Electrónica y xDrive								
	Derecho	72313	5616	903918	—	—	—	—	—
	Izquierdo	72314	5616	903918	—	—	—	—	—
	Aislador de Resorte Inferior	—	—	907967■	—	—	—	—	—
	Montura Superior	—	—	—	907984	—	—	—	—

### BMW — 525i

2004-07	Todos — Exc. c/ Susp. Deportiva								
	Derecho	72731	72746■	—	909908■	—	—	—	—
	Izquierdo	72732	72746■	—	909908■	—	—	—	—
	Todos — c/ Susp. Deportiva								
2001-Sep 03	Derecho	72733	—	—	909908■	—	—	—	—
	Izquierdo	72734	—	—	909908■	—	—	—	—
2001-03	Todos (E39) Sedán — Exc. c/ Sus. Elect. y c/ Susp. de Aire								
	Derecho	71455	71349	903918	—	—	—	—	—
	Izquierdo	71456	71349	903918 63638■	—	—	—	—	—

■ Número de parte bajo pedido especial



## APLICACIONES

		GAS-MAGNUM®		MONRO-MATIC PLUS®		ROADMATIC	
		BASES DE AMORTIGUADOR CUBREPOLVO		MONRO-MATIC® HIDRÁULICO		LOAD ADJUSTING® MAX-AIR®	

### BMW — 525iT

2001- Sep 03	Todos (E39) — Wagon	71455	—	903918	—	—	—	—	—
	Derecho	71456	—	903918	—	—	—	—	—
	Izquierdo			63638 ■	63632				

### BMW — 528i

2008-10	Todos — c/ Susp. Deportiva								
	Derecho	72733	—	—	909908 ■	—	—	—	—
	Izquierdo	72734	—	—	909908 ■	—	—	—	—
	Todos — Exc. c/ Susp. Deportiva								
Sep 1995- Sep 03	Derecho	72731	72746 ■	—	909908 ■	—	—	—	—
	Izquierdo	72732	72746 ■	—	909908 ■	—	—	—	—
Sep 1995- Sep 03	Todos (E39) Sedán — Exc. c/ Susp. Elect. y c/ Susp. de Aire								
	Derecho	71455	71349	903918	—	—	—	—	—
	Izquierdo	71456	71349	903918	—	—	—	—	—
				63638 ■					

### BMW — 528iT

Sep 1995-00	Todos Wagon — Exc. c/ Susp. Elect. y c/ Susp. de Aire								
	Derecho	71455	—	903918	—	—	—	—	—
	Izquierdo	71456	—	903918	—	—	—	—	—
				63638 ■	63632				

### BMW — 530i

2004-07	Todos — c/ Susp. Deportiva								
	Derecho	72733	—	—	909908 ■	—	—	—	—
	Izquierdo	72734	—	—	909908 ■	—	—	—	—
	Todos — Exc. c/ Susp. Deportiva								
2001-03	Derecho	72731	72746 ■	—	909908 ■	—	—	—	—
	Izquierdo	72732	72746 ■	—	909908 ■	—	—	—	—
2001-03	Todos (E39) Sedán — Exc. c/ Susp. Elect. y c/ Susp. de Aire								
	Derecho	71455	71349	903918	—	—	—	—	—
	Izquierdo	71456	71349	903918	—	—	—	—	—
				63638 ■					

### BMW — 535i

2011-16	Todos — Exc. Susp. Electrónica	—	—	—	909908 ■	—	—	—	—
2011-17	Todos GT — Exc. Susp. Electrónica	—	—	—	909908 ■	—	—	—	—
2008-10	Todos — c/ Susp. Deportiva								
	Derecho	72733	—	—	909908 ■	—	—	—	—
	Izquierdo	72734	—	—	909908 ■	—	—	—	—
	Todos — Exc. c/ Susp. Deportiva								
2008-10	Derecho	72731	72746 ■	—	909908 ■	—	—	—	—
	Izquierdo	72732	72746 ■	—	909908 ■	—	—	—	—

### BMW — 540iT

2000- Oct 03	Todos (E39) Wagon — Exc. c/ Susp. Elect. Ajustable	—	—	63638 ■	63632	—	—	—	—
-----------------	--	---	---	---------	-------	---	---	---	---

■ Número de parte bajo pedido especial



## APLICACIONES

### BMW — 540i

Sep 1995 - Sep 03	Todos (E39) Sedán — Exc. c/ Susp. Elect.	—	71349	—	—	—	—	—	—
				63638■					

### BMW — 545i

2004-05	Todos — c/ Susp. Deportiva								
	Derecho	72733	—	—	909908■	—	—	—	—
	Izquierdo	72734	—	—	909908■	—	—	—	—
	Todos — Exc. c/ Susp. Deportiva								
	Derecho	72731	72746■	—	909908■	—	—	—	—
	Izquierdo	72732	72746■	—	909908■	—	—	—	—

### BMW — 550i

2006-10	Todos — c/ Susp. Deportiva								
	Derecho	72733	—	—	909908■	—	—	—	—
	Izquierdo	72734	—	—	909908■	—	—	—	—
	Todos — Exc. c/ Susp. Deportiva								
	Derecho	—	72746■	—	909908■	—	—	—	—
	Izquierdo	—	72746■	—	909908■	—	—	—	—

### BMW — 645Ci

2004-05	Todos — Exc. c/ Susp. Elect.	—	—	—	909908■	—	—	—	—
---------	------------------------------	---	---	---	---------	---	---	---	---

### BMW — 740i, 740iL

1994-01	Todos (E38) Sedán — Exc. c/ Susp. Elect.	—	—	63638■	—	—	—	—	—
---------	--	---	---	--------	---	---	---	---	---

### BMW — X3

2004-11	Todos								
	Derecho	72547	39107	903918■	—	—	—	—	—
	Izquierdo	72548	39107	903918■	—	—	—	—	—

### BMW — X5

2014-18	Todos — Exc. Susp. Electrónica								
	Derecho	72944	5516	—	—	—	—	—	—
	Izquierdo	72944	5517	—	—	—	—	—	—
2007-13	Todos — 3.0L Exc.c/ Nivelación Automática, Susp. Electrónica y c/ Tercer Fila de Asientos.								
	Derecho	72916	37346	902133●	—	—	—	—	—
	Izquierdo	72916	37347	902133●	—	—	—	—	—
2000-06	Todos — Exc. Susp. De Aire	—	39051	—	—	—	—	—	—

### BMW — X6

2015-19	Todos — Exc. Susp. Electrónica								
	Derecho	72944	5516	—	—	—	—	—	—
	Izquierdo	72944	5517	—	—	—	—	—	—
2008-16	Todos	—	—	902133●	—	—	—	—	—

### BMW — Z3

1996-02	(E36) Todos — Exc. c/ Susp. Deportiva	—	5999	902905■	901965■	—	—	—	—
---------	---------------------------------------	---	------	---------	---------	---	---	---	---

### BMW — Z4

2003-08	Todos — Exc. Paquete M	—	5677	—	—	—	—	—	—
---------	------------------------	---	------	---	---	---	---	---	---

● Nuevo número de parte

■ Número de parte bajo pedido especial



## APLICACIONES

				BASES DE AMORTIGUADOR CUBREPOLVO		MONRO-MATIC HIDRÁULICO		LOAD ADJUSTING MAX-AIR	

### BUICK — Century

1997-05	Todos								
	Derecho	71661	71662	902973	902968	801661	801662	—	—
	Izquierdo	71661	71662	902973	902969	801661	801662	—	—
	Aislador de Resorte Superior	—	—	—	904941	—	—	—	—
	Aislador de Resorte Inferior	—	—	904943	—	—	—	—	—
				63622					
1985-96	Todos	—	5897	901934	901951	—	33108	—	—
				63622					
1982-84	Todos — Exc. c/ Susp. HD y Deportiva	—	5897	901934	—	—	—	—	—
				63622					

### BUICK — Encore

2013-22	Todos								
	Derecho	72934	5699	—	—	—	—	—	—
	Izquierdo	72935	5699	—	—	—	—	—	—

### BUICK — Enclave

2013-17	Todos	72949	37315	907986	—	—	33193	—	250020
	Aislador de Resorte Superior	—	—	909923	—	—	—	—	—
	Aislador de Resorte Inferior	—	—	909924	—	—	—	—	—
	Para Remolque	—	—	—	—	—	—	—	MA833
				63631					
2008-12	Todos	72518	37315	907986	—	—	33193	400018	250020
	Aislador de Resorte Superior	—	—	909923	—	—	—	—	—
	Aislador de Resorte Inferior	—	—	909924	—	—	—	—	—
	Para Remolque	—	—	—	—	—	—	—	MA833
				63631					

### BUICK — Envision

2016-20	Todos	—	37390	—	—	—	—	—	—
---------	-------	---	-------	---	---	---	---	---	---

### BUICK — LaCrosse

2017-19	Todos — Exc. Susp. Elect. Ajustable								
	Derecho	73090	—	—	—	—	—	—	—
	Izquierdo	73091	—	—	—	—	—	—	—
2016	AWD — Exc. c/ Susp. Elect.								
	Derecho	—	5647	907987	907925	—	—	—	—
	Izquierdo	72516	5647	907987	907924	—	—	—	—
				63621					
	FWD — Exc. c/ Susp. Elect.								
	Derecho	72528	5647	907987	—	—	—	—	—
	Izquierdo	72529	5647	907987	—	—	—	—	—
				63621					
2010-15	AWD — Exc. c/ Susp. Elect. Y Paq. Performance								
	Derecho	—	5647	907987	—	—	—	—	—
	Izquierdo	72516	5647	907987	—	—	—	—	—
				63621					

- Nuevo número de parte
- Número de parte bajo pedido especial

® Este número de pieza es una marca registrada de Tenneco y no se puede usar ni reproducir sin permiso.

## APLICACIONES

	<b>OESpectrum</b>	<b>GAS-MAGNUM®</b>		<b>MONRO-MATIC PLUS®</b>		<b>ROADMATIC</b>	
	<b>Reflex</b>	BASES DE AMORTIGUADOR CUBREPOLVO		MONRO-MATIC® HIDRÁULICO		LOAD ADJUSTING® MAX-AIR®	

### BUICK — LaCrosse (Cont.)

2010-15 (Cont.)	FWD — Exc. c/ Susp. Elect. Y Paq. Performance								
	Derecho	72528	5647	907987	—	—	—	—	—
	Izquierdo	72529	5647	907987 63621	—	—	—	—	—

### BUICK — Regal

2015-17	AWD — Exc. c/ Susp. Activa								
	Derecho	—	5662■	907987	908925	—	—	—	—
	Izquierdo	—	5662■	907987 63631	908924	—	—	—	—
	FWD — Exc. c/ Susp. Activa	—	5662■	907987 63631	—	—	—	—	—
2011-14	Todos — Exc. c/ Susp. Activa								
	Derecho	—	5662■	907991	908925	—	—	—	—
	Izquierdo	—	5662■	907991 63631	908924	—	—	—	—
1988-96	Todos	—	—	901921	—	—	—	—	—

### BUICK — Verano

2012-17	Todos — c/ VIN posterior a #C4141115								
	Derecho	72663	5689	908995	908993	—	—	—	—
	Izquierdo	72664	5689	908995 63631	908993	—	—	—	—

### CADILLAC — ATS

2016-18	Base y Luxury c/ AWD	—	5664	—	—	—	—	—	—
	Base y Luxury c/ RWD — Exc. Modelos V y Premium RWD c/ Susp. Magnetic Ride Control								
	Derecho	72631	5664	—	—	—	—	—	—
	Izquierdo	72632	5664	—	—	—	—	—	—
2013-15	Base, Luxury, Premium y Performance c/ AWD	—	5664	909909	—	—	—	—	—
	Base, Luxury y Performance c/ RWD Exc. Modelos V y Premium RWD c/ Susp. Magnetic Ride Control								
	Derecho	72631	5664	909909	—	—	—	—	—
	Izquierdo	72632	5664	909909	—	—	—	—	—

### CADILLAC — Catera

1997-01	Todos	71503	—	903932 63619	—	—	—	—	—
---------	-------	-------	---	-----------------	---	---	---	---	---

### CADILLAC — Cimarron

1983-88	Cimarron — Todos	—	5896	— 63622	901951	—	—	—	—
---------	------------------	---	------	------------	--------	---	---	---	---

■ Número de parte bajo pedido especial



## APLICACIONES

	OESpectrum <i>Reflex</i>		GAS-MAGNUM® BASES DE AMORTIGUADOR CUBREPOLVO		MONRO-MATIC PLUS® MONRO-MATIC® HIDRÁULICO		ROADMATIC LOAD ADJUSTING® MAX-AIR®	

### CADILLAC — CTS

2014-19	RWD — c/ Base, Modelos Luxury — Exc. Susp. Electrónica y Susp. Performance Derecho	—	5539 ■	909909	—	—	—	—	—
	Izquierdo	73038 ■	5539 ■	909909	—	—	—	—	—
	AWD — c/ Base, Modelos Luxury — Exc. Susp. Electrónica y Susp. Performance	—	5539 ■	909909	—	—	—	—	—
2008-13	RWD — Exc. c/ Magna Ride y Nivomat	—	39114	902134 ●	—	—	—	—	—
	AWD — Exc. Magna Ride	72922 ■	—	902134 ●	—	—	—	—	—
2003-07	Todos — c/ Suspensión FE1	—	39114	902134 ●	—	—	—	—	—

### CADILLAC — DeVille

1985-90	RWD	5801	5802	—	—	32066	—	—	—
1977-84	Todos	5801	5802	—	—	32066	—	—	—

### CADILLAC — Eldorado

1955-64	Todos	—	—	—	—	—	31125	—	—
---------	-------	---	---	---	---	---	-------	---	---

### CADILLAC — Escalade

2015-16	Todos	—	—	902035	—	—	—	—	—
	Aislador Superior	—	—	907942	—	—	—	—	—
2007-14	Todos — c/ Susp. Electrónica (Z55) Exc. Magnetic Ride Control (Z95) y Rin de 22" Aislador Superior	40047	40050	—	—	—	—	—	—
	Todos — c/ Susp. Electrónica (Z55) y Rin de 22" Exc. Magnetic Ride Control (Z95) Aislador de Resorte Superior	40049	40052	—	—	—	—	—	—
	Todos — c/ Susp. Electrónica (Z55) y Rin de 22" Exc. Magnetic Ride Control (Z95) Aislador de Resorte Superior	—	—	907942	—	—	—	—	—
2002-06	2WD y AWD — Todos 4 Puertas c/ Susp. Electrónica	40044	40034	—	—	—	—	—	—
2007-13	EXT — Todos c/ Susp. Electrónica y Rin de 22" Exc. Magnetic Ride Control (Z95)	40049	40052	—	—	—	—	—	—
2002-06	EXT — Todos c/ Susp. Electrónica	40044	—	—	—	—	—	—	—
	EXT — Todos Exc. c/ Susp. Electrónica	911505	911506	—	—	—	—	—	—
1999-00	Todos	—	37086	34798	34763	32263R	—	—	—
	Para Remolque	—	—	—	—	—	—	—	58612 ■

### CADILLAC — Seville

1976-79	Todos	5840	—	—	—	32132	—	250132	MA780 ■ □
---------	-------	------	---	---	---	-------	---	--------	-----------

### CADILLAC — SRX

2016	Exc. c/ Susp. Electrónica.	72909	37350	—	—	—	—	—	—
2010-15	Exc. c/ Susp. Electrónica.	72909	37350	902051 ●	—	—	—	—	—
2004-09	Todos c/ Susp. FE 1	39134	—	902134 ●	—	—	—	—	—

### CADILLAC — STS

2005-09	Todos c/ Susp. Autonivelable — Exc. Susp. Electrónica, Magnetic Ride Control y AWD	39135	40056	902134 ●	—	—	—	—	—
---------	--	-------	-------	----------	---	---	---	---	---

● Nuevo número de parte

■ Número de parte bajo pedido especial

R Monro-Matic Plus Reforzado

□ Se requiere el juego de adaptadores AK16 para reemplazar amortiguadores neumáticos ajustables en los vehículos equipados con un sistema de nivelación automática.

## APLICACIONES

	<b>OESpectrum</b>	<b>GAS-MAGNUM®</b>		<b>MONRO-MATIC PLUS®</b>		<b>ROADMATIC</b>	
	<b>Reflex</b>	BASES DE AMORTIGUADOR CUBREPOLVO		MONRO-MATIC® HIDRÁULICO		LOAD ADJUSTING® MAX-AIR®	

### CHEVROLET — Astra

2000-08	Todos	—	5659	906908	—	—	—	—	—
	Todos Exc. c/ Frenos ABS								
	Derecho	72892	5659	906908	—	72892	—	—	—
	Izquierdo	72893	5659	906908	—	72893	—	—	—

### CHEVROLET — Astro (Mini Van)

1985-05	2WD	37063	37064	—	—	32066	32212	—	—
1990-05	AWD	37062	37064	—	—	32254	32212	—	—

### CHEVROLET — Avalanche

2007-13	2WD y 4WD 1500 — Exc. c/ Susp. Electrónica	39104	911506	905910	—	—	—	—	—
	Aislador Superior y Cubrepolvo	—	—	907942	—	—	—	—	—
	Todos — c/ Susp. Electrónica y Rin de 22" Exc. Magnetic Ride Control (Z95)	40049	40052	—	—	—	—	—	—
2002-06	2WD y 4WD 1500 — Exc. c/ Susp. Electrónica	911505	911506	—	—	—	—	—	—
	2WD y 4WD 1500 — c/ Susp. Electrónica	40044	40050	—	—	—	—	—	—
	2WD y 4WD 2500 — Todos	37181 911181	—	34504	—	32350R	32345R	—	—

### CHEVROLET — Avalanche Amortiguador de Dirección

								<b>Sin Soporte</b>	<b>Con Soporte</b>
2002-06	2500 2WD y 4WD							SC2963	—

### CHEVROLET — Aveo

2004-18	Todos								
	Derecho	72295	5794	905906	905981	—	—	400295	250794
	Izquierdo	72296	5794	905906	905981	—	—	400296	250794

### CHEVROLET — Beat

2017-20	Todos								
	Derecho	73019	5537	—	—	—	—	—	—
	Izquierdo	73020	5537	—	—	—	—	—	—

### CHEVROLET — Beretta

1996	Todos	—	5970	904912 <sup>[7]</sup>	901951	—	—	—	—
				63621					
1995	Todos	—	5970	904912 <sup>[7]</sup>	901951	—	—	—	—
				63621					
1992-94	Todos	—	5896	—	901951	—	—	—	—
				63621					
1987-91	Todos	—	5896	901929	901951	—	—	—	—
				63622					

### CHEVROLET — Blazer

1994-05	2WD — Exc Trailblazer 2002-05	37129	37021	—	—	32300	32186	250300	250186
	Para Remolque	—	—	—	—	—	—	—	58523■
	Para Remolque	—	—	—	—	—	—	—	MA759
1983-93	2WD	37019	37021	—	—	32132	32186	250132	250186

■ Número de parte bajo pedido especial

R Monro-Matic Plus Reforzado

[7] El balero 901928 está disponible cuando se necesite reemplazar el balero solamente.





## APLICACIONES

		GAS-MAGNUM®		MONRO-MATIC PLUS®		ROADMATIC	
		BASES DE AMORTIGUADOR CUBREPOLVO		MONRO-MATIC® HIDRÁULICO		LOAD ADJUSTING® MAX-AIR®	

### CHEVROLET — Blazer (Cont.)

1994-05	4WD — Exc. c/ Paquete ZR2 Para Remolque Para Remolque	37099 — —	37021 — —	— — —	— — —	32194 — —	32186 — —	250194 — —	250186 58523■ MA759
1994-03	4WD — 2 Puertas c/ Paquete ZR2	911514	—	—	—	—	—	—	—
1983-93	4WD Para Remolque Para Remolque	37099 — —	37021 — —	— — —	— — —	32194 — —	32186 — —	250194 — —	250186 58523■ MA759
1973-90	4WD — Inc. Modelos Jimmy	37040	37041	34944	34824	—	—	—	—
1969-72	4WD — Inc. Modelos Jimmy	—	—	34944	34822	—	—	—	—

### CHEVROLET — Blazer Amortiguador de Dirección

		Sin Soporte	Con Soporte
1983-05	S-10 4WD	SC2937	—
1973-91	4WD — Reemplaza # de E.O. 3196958, 4941313, 4984618, 4993563 y 22002710	SC2913	—

### CHEVROLET — Camaro

2016 - 18	Modelo SS Exc. Magnetic Ride Control Derecho Izquierdo	73055■ 73056■	5543 5543	— —	— —	— —	— —	— —	— —
2016	Todos — c/ Motor V6 L4 Exc. Magnetic Ride Control Derecho Izquierdo	73053■ 73054■	5543 5543	— —	— —	— —	— —	— —	— —
2013-15	Todos — c/ Motor V6 Derecho Izquierdo	— 72913	73029 73029	🔧907991 🔧907991 Ⓞ63621	🔧907992 🔧907992	— —	— —	— —	— —
	Todos — c/ Motor V8 Exc. ZL1 y SS, c/ Paquete de alto desempeño y Motor 7.0L Derecho Izquierdo	— 72915	73030 73030	🔧907991 🔧907991 Ⓞ63621	🔧907992 🔧907992	— —	— —	— —	— —
2010-12	Todos c/ Motor V6	—	73029	—	—	—	—	—	—
1993-02	Todos — Inc. Z-28 Asiento de Resorte Inferior	72362 —	5867 —	— 904962■	— —	— —	— —	— —	— —
1982-92	Todos — Inc. Z-28	71728 <sup>8</sup> <sub>26</sub>	5867	—	—	—	—	—	—
1970-81	Todos — Inc. Z-28	5801	5831	—	—	32066	—	—	—

### CHEVROLET — Caprice

1966-81	Todos	5801	5802	—	—	32066	—	—	—
---------	-------	------	------	---	---	-------	---	---	---

### CHEVROLET — Captiva Sport

2012-15	Sport — Todos Derecho Izquierdo	72526 72527	37359 37359	🔧906956 🔧906956 Ⓞ63630	— —	— —	— —	400026 400027	— —
---------	---------------------------------------	----------------	----------------	------------------------------	--------	--------	--------	------------------	--------

■ Número de parte bajo pedido especial

<sup>8</sup> El compresor de resorte NO ES necesario para reemplazar los struts en este vehículo.

<sup>26</sup> Puede que se requiera el juego de piezas AK41 para reemplazar los tornillos y las tuercas originales del montaje inferior si están dañados o si no es posible reutilizarlos.



## APLICACIONES

### CHEVROLET — Captiva

2008-11	Todos								
	Derecho	72526	—	906956	—	—	—	400026	—
	Izquierdo	72527	—	906956 63630	—	—	—	400027	—

### CHEVROLET — Cavalier

2000-05	Todos	—	71281	—	902949 <sup>®</sup>	—	801281	—	—
	Aislador de Resorte Inferior	—	—	904940■ 63619	—	—	—	—	—
1995-99	Primer Diseño	—	71281	904912 <sup>72</sup>	902949 <sup>®</sup>	—	801281	—	—
	Aislador de Resorte Inferior	—	—	904940■ 63619	—	—	—	—	—
1992-94	Todos	—	5896	901929 63620	901951	—	—	—	—
1984-91	Todos	—	5896	—	901951	—	—	—	—
				63622					

### CHEVROLET — Celebrity

1985-90	Todos	—	5897	901934 63622	901951	—	33108	—	—
1984	Todos — Exc. Susp. HD y Susp. Deportiva	—	5897 <sup>46</sup>	901934	—	—	33108	—	—
1982-83	Todos	—	5897 <sup>46</sup>	901934 63622	—	—	33108	—	—

### CHEVROLET — Chevelle

1973-77	Todos	5840	5802	—	—	32132	—	250132	—
1968-72	Todos	5840	5802	—	—	—	—	—	—

### CHEVROLET — Chevy, Chevy Joy, Pop y Swing

1993-12	Todos	—	—	906907	—	MW004	3147	400004	250147
---------	-------	---	---	--------	---	-------	------	--------	--------

### CHEVROLET — Chevy Nova

1975-79	Todos	5840	5931	—	—	32132	—	250132	—
---------	-------	------	------	---	---	-------	---	--------	---

### CHEVROLET — Chevy Pickup

1993-05	Todos	—	—	—	—	MW004	3155	400004	—
---------	-------	---	---	---	---	-------	------	--------	---

### CHEVROLET — Citation

1985	Todos	—	5897	901934 63622	901951	—	33108	—	—
1982-84	Todos — Exc. Mod. 1984 c/ Susp. HD	—	5897 <sup>46</sup>	901934 63622	—	—	33108	—	—

### CHEVROLET — City Express

2015-18	Todos								
	Derecho	72668	37334	—	—	—	—	—	—
	Izquierdo	72669	37334	—	—	—	—	—	—

### CHEVROLET — Colorado Pickup

2015-22	2WD — Exc. ZR2	72919	37351	902052●	—	—	—	—	—
---------	----------------	-------	-------	---------	---	---	---	---	---

● Nuevo número de parte

■ Número de parte bajo pedido especial

® Este número de pieza es una marca registrada de Tenneco y no se puede usar ni reproducir sin permiso.

<sup>46</sup> Se requiere el juego de piezas AK79 para instalar un PAR de estas unidades en esta aplicación.

<sup>72</sup> El balero 901928 está disponible cuando se necesite reemplazar el balero solamente.



## APLICACIONES

	<b>OESpectrum</b>	<b>GAS-MAGNUM®</b>		<b>MONRO-MATIC PLUS®</b>		<b>ROADMATIC</b>	
	<b>Reflex</b>	BASES DE AMORTIGUADOR CUBREPOLVO		MONRO-MATIC® HIDRÁULICO		LOAD ADJUSTING® MAX-AIR®	

### CHEVROLET — Colorado Pickup (Cont.)

2004-12	2WD — Todos c/ Susp. Delantera de Resorte Aislador de Resorte Superior	71353	911228	—	—	—	—	—	—
		—	—	909921	—	—	—	—	—
	2WD — Todos c/ Susp. Delantera de Barra de Torsión Aislador de Resorte Superior	911229	911230	—	—	33178	33179	—	—
		—	—	909921	—	—	—	—	—
2015-18	4WD — Exc. ZR2	72919	37351	—	—	—	—	—	—
2004-12	4WD Aislador de Resorte Superior	911229	911230	—	—	—	—	—	—
		—	—	909921	—	—	—	—	—

### CHEVROLET — Corsa

2001-08	Sedán								
	Derecho	71026	5785	906908	—	—	3147	400000	250147
	Izquierdo	71027	5785	906908	—	—	3147	400001	250147
	Hatchback								
	Derecho	71026	5778	—	—	—	—	400000	—
	Izquierdo	71027	5778	—	—	—	—	400001	—

### CHEVROLET — Corsica

1995-96	Todos	—	5970	904912	901951	—	—	—	—
				63621					
1992-94	Todos	—	5896	—	901951	—	—	—	—
				63621					
1987-91	Todos	—	5896	901929	901951	—	—	—	—
				63622					

### CHEVROLET — Corvette

1997-04	Todos — Exc. c/ Control de Manejo Selectivo Magnetico F55	5602	5603	—	—	—	—	—	—
1988-96	Todos	5892	5939	—	—	—	—	—	—
1984-87	Todos	5892	5893	—	—	—	—	—	—
1962-82	Todos Para Remolque	5906	5850	—	—	—	—	—	MA785
		—	—	—	—	—	—	—	

### CHEVROLET — Cruze

2016-19	Modelos LT y Premier								
	Derecho	73062	5561	—	—	—	—	—	—
	Izquierdo	73063	5561	—	—	—	—	—	—
2016-17	Modelos L, LS								
	Derecho	73060	5561	—	—	—	—	—	—
	Izquierdo	73061	5561	—	—	—	—	—	—
2012-15	Todos — Exc. Susp. Deportiva, c/ VIN posterior a #C7239134								
	Derecho	72663	5663	908995	908993	—	—	—	—
	Izquierdo	72664	5663	908995	908993	—	—	—	—
				63631					
2010-12	Todos — Exc. Susp. Deportiva y c/ VIN C7239134 y anterior.								
	Derecho	72626	5663	908995	908993	—	—	—	—
	Izquierdo	72627	5663	908995	908993	—	—	—	—
				63632					

● Nuevo número de parte

■ Número de parte bajo pedido especial

☐ El balero 901928 está disponible cuando se necesite reemplazar el balero solamente.



## APLICACIONES

### CHEVROLET — Cruze (Cont.)

2016	Limited								
	Derecho	72626	5663	☞908995	☞908993	—	—	—	—
	Izquierdo	72627	5663	☞908995	☞908993	—	—	—	—
				☞63631					

### CHEVROLET — Equinox

2018-22	Todos	—	37390●	—	—	—	—	—	—
2010-17	Todos								
	Derecho	72526	911258	☞906956	—	—	—	400026	250012●
	Izquierdo	72527	911258	☞906956	—	—	—	400027	250012●
				☞63630					
2008-09	Todos — Exc. Susp. Sport								
	Derecho	72526	911258	☞906956	—	—	—	400026	250012●
	Izquierdo	72527	911258	☞906956	—	—	—	400027	250012●
				☞63630					
	Todos — c/ Sport								
	Derecho	—	911258	☞906956	—	—	—	—	250012●
	Izquierdo	—	911258	☞906956	—	—	—	—	250012●
				☞63630					
2007	Todos								
	Derecho	72526	911258	☞906956	—	—	—	400026	250012●
	Izquierdo	72527	911258	☞906956	—	—	—	400027	250012●
2005-06	Todos								
	Derecho	72209	911258	☞905980	—	—	—	—	250012●
	Izquierdo	72210	911258	☞905980	—	—	—	—	250012●

### CHEVROLET — HHR

2006-11	Todos — Exc. SS	72179	5779	☞905907	—	—	—	—	—
				☞63619					

### CHEVROLET — Impala

2014-20	Todos								
	Derecho	72976	5647	☞907987	☞908925	—	—	—	—
	Izquierdo	72977	5647	☞907987	☞908924	—	—	—	—
				☞63631					
2012-13	Taxi y Patrulla								
	Derecho	—	—	—	553023	—	—	—	—
	Izquierdo	—	—	☞902973®	☞902968	—	—	—	—
				—	553023	—	—	—	—
				☞902973®	☞902969	—	—	—	—
	Aislador de Resorte Superior	—	—	—	904941■	—	—	—	—
	Aislador de Resorte Inferior	—	—	904943■	904941■	—	—	—	—
				☞63622	☞63622				
2010-13	Sedán								
	Derecho	71661	—	☞902973®	☞902968	801661	801662	—	—
	Izquierdo	71661	—	☞902973®	☞902969	801661	801662	—	—
	Aislador de Resorte Superior	—	—	—	904941■	—	—	—	—
	Aislador de Resorte Inferior	—	—	904943■	904941■	—	—	—	—
				☞63622	☞63622				

● Nuevo número de parte

■ Número de parte bajo pedido especial

® Este número de pieza es una marca registrada de Tenneco y no se puede usar ni reproducir sin permiso.



## APLICACIONES

### CHEVROLET — Impala (Cont.)

2000-09	Sedán — Exc. Patrulla, Modelos c/ Rines de 17" o 18"								
	Derecho	71661	71662	902973®	902968	801661	801662	—	—
	Izquierdo	71661	71662	902973®	902969	801661	801662	—	—
	Aislador de Resorte Superior	—	—	—	904941■	—	—	—	—
	Aislador de Resorte Inferior	—	—	904943■	904941■	—	—	—	—
				63622	63622				
2000-05	Patrulla y Taxi								
	Derecho	—	71671	902973®	902969	—	—	—	—
	Izquierdo	—	71671	902973®	902968	—	—	—	—
	Aislador de Resorte Inferior	—	—	904943■	904941■	—	—	—	—
				63622	63622				
1994-96	SS	5906	5966■	—	—	—	—	—	—
1982-85	Todos — Exc. Patrulla	5801	5955■	—	—	—	—	—	—
1965-81	Todos — Exc. Patrulla	5801	5802	—	—	32066	—	—	—

### CHEVROLET — Impala Limited

2014-16	Patrulla y Taxi								
	Derecho	—	—	—	553023	—	—	—	—
	Izquierdo	—	—	902973®	902968	—	—	—	—
	Aislador de Resorte Inferior	—	—	902973®	902969	—	—	—	—
				904943■	904941■	—	—	—	—
				63622	63622				
	Sedán Exc. Patrulla y Taxi								
	Derecho	72903	—	902973®	902968	—	—	—	—
	Izquierdo	72903	—	902973®	902969	—	—	—	—
	Aislador de Resorte Inferior	—	—	904943■	904941■	—	—	—	—
				63622	63622				

### CHEVROLET — LLV

1987-95	Todos	—	—	34945	34934	—	—	—	—
---------	-------	---	---	-------	-------	---	---	---	---

### CHEVROLET — Lumina

1997-01	Todos								
	Derecho	—	71663	901921	902968	—	—	—	—
	Izquierdo	—	71663	901921	902969	—	—	—	—
1995-96	Todos								
	Derecho	—	71972	901921	902968	—	—	—	—
	Izquierdo	—	71972	901921	902969	—	—	—	—
1989-96	Van — Exc. c/ Sist. de Autonivelación Trasero	—	—	901934	901951	—	—	—	—
				63622					
	Van — c/ Sist. de Autonivelación Tras.	—	—	901934	901951	—	—	—	—
				63622					

### CHEVROLET — Luv Pickup

1997-06	2WD	37047	37029	—	—	32206	31094	250016●	250014●
1981-83	2WD	—	—	—	—	32206	31094	250016●	250014●
1981-82	4WD	—	—	—	—	32113	31094	—	250014●

● Nuevo número de parte

■ Número de parte bajo pedido especial

® Este número de pieza es una marca registrada de Tenneco y no se puede usar ni reproducir sin permiso.



## APLICACIONES

	<b>OESpectrum</b> <i>Reflex</i>		<b>GAS-MAGNUM®</b> BASES DE AMORTIGUADOR CUBREPOLVO		<b>MONRO-MATIC PLUS®</b> MONRO-MATIC® HIDRÁULICO		<b>ROADMATIC</b> LOAD ADJUSTING® MAX-AIR®	

### CHEVROLET — Malibu

2016-22	Todos								
	Derecho	73051	5547	—	—	—	—	—	—
	Izquierdo	73052	5547	—	—	—	—	—	—
2014-15	Todos								
	Derecho	72910	5647	907987	—	—	—	—	—
	Izquierdo	72911	5647	907987	—	—	—	—	—
2013	Todos								
	Derecho	72528	5647	907987	—	—	—	—	—
	Izquierdo	72529	5647	907987	—	—	—	—	—
2008-12	Todos — Exc. Híbrido								
	Derecho	72199	5778	905908	907990	—	—	—	—
	Izquierdo	72200	5778	905909	907990	—	—	—	—
				63619					
2008-09	Híbrido								
	Derecho	72199	5521	905908	907990	802199	—	400019●	—
	Izquierdo	72200	5521	905909	907990	802200	—	400020●	—
				63619					
2008	Classic LS, Classic LT								
	Derecho	72199	5780	905908	—	—	33195	—	250015●
	Izquierdo	72200	5780	905909	—	—	33195	—	250015●
				63619					
2006-07	Todos								
	Derecho	72199	5780	905908	—	—	33195	—	250015●
	Izquierdo	72200	5780	905909	—	—	33195	—	250015●
				63619					
2004-05	Todos — Exc. Modelo Clásico								
	Derecho	72199	5780	905908	—	—	33195	—	250015●
	Izquierdo	72200	5780	905909	—	—	33195	—	250015●
				63619					
1999-03	Todos	—	71686	—	—	—	—	—	—
				63622	63619				
1997-98	Primer Diseño	—	—	—	—	—	—	—	—
				63622	63619				

### CHEVROLET — Matiz

2011-15	Todos								
	Derecho	72602	5661	—	—	—	—	400002	250003
	Izquierdo	72603	5661	—	—	—	—	400003	250003

### CHEVROLET — Meriva

2003-08	Todos								
	Derecho	71026	—	—	—	MW004	33159	400004	—
	Izquierdo	71027	—	—	—	MW004	33159	400004	—

### CHEVROLET — Monte Carlo

1997-99	Todos								
	Derecho	—	71663	901921	902969	—	—	—	—
	Izquierdo	—	71663	901921	902968	—	—	—	—
				63622	63620				
1973-88	Todos	5840	5802	—	—	32132	—	250132	—

### CHEVROLET — Monza

1993-12	Todos	—	—	906907	—	MW004	3147	400004	250147
---------	-------	---	---	--------	---	-------	------	--------	--------

● Nuevo número de parte



## APLICACIONES

### CHEVROLET — Optra

2006-10	Todos	—	72451			—	—	—	—
	Derecho	—	72450			—	—	—	—
	Izquierdo	—	72450			—	—	—	—

### CHEVROLET — Pickup Cheyenne

2021-22	LT y RST	73116●	911150	—	—	—	—	—	—
	High Country — Exc. Susp. Elect. Ajustable	73116●	911150	—	—	—	—	—	—
2020	Todos — Exc. Trail Boss	73116●	911150	—	—	—	—	—	—
2019	Modelo Nuevo — Exc. Custom Trail Boss	73116●	911150	—	—	—	—	—	—
2017-18	Todos — Exc. Susp. Elect. Ajustable	—	911150	—	—	—	—	—	—
2007-16	Todos — Exc. Susp. Elect. Ajustable	39105	911150	—	—	—	—	—	—

### CHEVROLET — Pickup C y R

1987-99	2WD (1/2 Ton) C-1500 — Todos	911050	911044	34983	34985	32224R	32225R	250224	—
1973-87	2WD (1/2 Ton) C-10, R-10 — Todos	37049	37041	34817	34824	1414	1415	—	—
1963-72	2WD (1/2 Ton) C-10 — Todos Exc. c/ Susp. Trasera de Resorte	37049	—	34817	34803	33033R 1414	31000 1412	—	250001●
1987-00	2WD (3/4 Ton) C-2500 — Todos Exc. Modelos HD	911050	911044	34983	34985	32224R	32225R	250224	—
	2WD (3/4 Ton) C-2500 — Todos Modelos HD c/ 8,600 lb. PBV	911050	911044	34741	34985	32362R	32225R	—	—
1973-89	2WD (3/4 Ton) C-20, R-20, R-2500 — Todos	37049	37041	34817	34824	33033R	33084R	—	—
1992-00	2WD (1 Ton) C-3500 — Todos	911050	911044	34741	34985	32362R	32225R	—	—
1973-91	2WD (1 Ton) C-30, R-30, R-3500 — Todos	—	—	34817	34960	33033R	—	—	—

### CHEVROLET — Pickup C y R Amortiguador de Dirección

		Sin Soporte	Con Soporte
1960-87	C-10 — Todos	SC2915	SA1932
1960-86	C-20 — Todos	SC2915	SA1932
1960-91	C-30 — Todos	SC2915	SA1932

### CHEVROLET — Pickup K y V

1987-99	4WD (1/2 Ton) K-1500 — Todos Monotubo para Alto Desempeño	911043 911511	911044 911512	34798 —	34985 —	32263R —	32225R —	— —	— —
1981-87	4WD (1/2 Ton) K-10 y V-10 — Todos c/ Susp. Quad Delantero Interior (2 requeridos)	—	37041	34910	34824	33086R	33084R	—	—
	Delantero Exterior (2 requeridos)	37040	37041	34944	34824	—	—	—	—
1973-87	4WD (1/2 Ton) K-10 y V10 — Todos Exc. Susp. Quad	37040	37041	34944	34824	—	—	—	—
1987-00	4WD (3/4Ton) K-2500 — Todos Exc. c/ 8,600 lb. PBV	911043	911044	34798	34985	32263R	32225R	—	—

● Nuevo número de parte

R Monro-Matic Plus Reforzado



## APLICACIONES

	<b>OESpectrum</b>	<b>GAS-MAGNUM®</b>	<b>MONRO-MATIC PLUS®</b>		<b>ROADMATIC</b>	
	<b>Reflex</b>	BASES DE AMORTIGUADOR CUBREPOLVO	MONRO-MATIC® HIDRÁULICO		LOAD ADJUSTING® MAX-AIR®	

### CHEVROLET — Pickup K y V (Cont.)

1987-00 (Cont.)	4WD (3/4Ton) K-2500 — Todos c/ 8,600 lb. PBV	911190■	911044	34799	34985	32373R	32225R	—	—
1981-86	4WD (3/4 Ton) K-20 y V-20 — Todos c/ Susp. Quad	—	37041	34910	34824	—	—	—	—
	Delantero Interior (2 requeridos)	37040	37041	34944	34824	—	—	—	—
1973-86	4WD (3/4 Ton) K-20 — Todos	37040	37041	34944	34824	—	—	—	—
	Exc. c/ Susp. Quad	—	—	34944	34822	—	—	—	—
1969-72	4WD (3/4 Ton) K-20 — Todos	—	—	34944	34822	—	—	—	—
1987-00	4WD (1 Ton) K-3500 — Todos	911190■	911044	34799	34985	32373R	32225R	—	—
1977-91	4WD (1 Ton) V-30, V-3500, K-30 — Todos	—	—	34919■	34920■	—	—	—	—

### CHEVROLET — Pickup K y V Amortiguador de Dirección

		Sin Soporte	Con Soporte
1987-99	K-1500 4WD - Todos s/ Amortiguador de Dirección de E.O.	SC2942	—
1970-72	K-10 — Todos	SC2916	—
1960-69	K-10 1/2 Ton 4WD	SC2917 <sup>[33]</sup> <sup>[34]</sup> <sup>[33]</sup>	—
	K-20 3/4 Ton 4WD	SC2917 <sup>[33]</sup> <sup>[34]</sup> <sup>[33]</sup>	—

### CHEVROLET — Pickup Silverado

2019-22	2WD (1/2 Ton) 1500 — Exc. Susp. Electronica y LD	73116●	911533	—	—	—	—	—	—
2019	Para Remolque	—	—	—	—	—	—	—	58654
	Para Remolque	—	—	—	—	—	—	—	MA834■
2019	2WD (1/2 Ton) 1500 LD — Exc. Z95	39112	911533	902035	552001	—	—	—	—
	Magnetic Ride Control	—	—	907942	—	—	—	—	—
2014-18	Aislador Superior y Cubrepolvo	—	—	—	—	—	—	—	58654
	Para Remolque	—	—	—	—	—	—	—	MA834■
2014-18	2WD (1/2 Ton) 1500 — Exc. Z95	39112	911533	902035	552001	—	—	—	—
	Magnetic Ride Control	—	—	907942	—	—	—	—	—
2007-13	Aislador Superior y Cubrepolvo	—	—	—	—	—	—	—	58654
	Para Remolque	—	—	—	—	—	—	—	MA834■
2007-13	2WD (1/2 Ton) 1500 — Exc. 1500	39105	911533	905910	552001	—	—	—	—
	HD y Suspensión Electronica	—	—	907942	—	—	—	—	—
2014	Aislador Superior y Cubrepolvo	—	—	—	—	—	—	—	58654
	Para Remolque	—	—	—	—	—	—	—	MA834■
2014	2WD (1/2 Ton) 1500 — Todos	39112	—	—	—	—	—	—	—
2007-13	2WD (1/2 Ton) 1500 — Exc. 1500	39105	911533	905910	—	—	—	—	—
	HD y c/ Suspensión Electrónica	—	—	907942	—	—	—	—	—
2007-13	Aislador Superior y Cubrepolvo	—	—	—	—	—	—	—	—
	Para Remolque	—	—	—	—	—	—	—	—

● Nuevo número de parte

■ Número de parte bajo pedido especial

R Monro-Matic Plus Reforzado

[33] Se venden los cilindros como cilindros de repuesto para los juegos de estabilizador de dirección.

[34] Juego de fuelle SA-19XX está disponible para el uso con nuestros cilindros de estabilizador de dirección.





## APLICACIONES

				BASES DE AMORTIGUADOR		MONRO-MATIC HIDRÁULICO		LOAD ADJUSTING	
				CUBREPOLVO				MAX-AIR	

### CHEVROLET — Pickup Silverado (Cont.)

2005-07	2WD (1/2 Ton) 1500HD — Todos Crew Cab c/ Susp. Delantera de Barra de Torsión Exc. c/ Sist. de Manejo Elect. Para Remolque	37181 911181	37164 911164	34504	34960	32350R	32341	—	—
		—	—	—	—	—	—	—	58638■
1999-07	2WD (1/2 Ton) 1500 — Serie Clásica Exc. Modelos HD y c/ Control de Manejo Electrónico Monotubo para Alto Desempeño Para Remolque Para Remolque	911149 911503	911150 911504	34675	34676	32326R	32327R	—	—
		—	—	—	—	—	—	—	58636■ MA828
2001-03	2WD (1/2 Ton) 1500HD — Todos Crew Cab c/ Susp. Delantera de Barra de Torsión Para Remolque	37181 911181	37164 911164	34504	34690	32350R	32341	—	—
		—	—	—	—	—	—	—	58638■
2020-22	4WD (1/2 Ton) 1500 — Exc. Susp. Electrónica, LD y TrailBoss Para Remolque Para Remolque	73116●	911533	—	—	—	—	—	—
		—	—	—	—	—	—	—	58654 MA834■
2019	4WD (1/2 Ton) 1500 LD Aislador Superior y Cubrepolvo Para Remolque Para Remolque	39112	911533	■902035 ■907942	552001	—	—	—	—
		—	—	—	—	—	—	—	58654 MA834■
2014-18	4WD (1/2 Ton) 1500 — Exc. Paq. Z95 Aislador Superior y Cubrepolvo Para Remolque Para Remolque	39112	911533	■902035 ■907942	552001	—	—	—	—
		—	—	—	—	—	—	—	58654 MA834■
2007-13	4WD (1/2 Ton) 1500 Todos — Exc. 1500HD y Suspensión Electrónica Aislador Superior y Cubrepolvo Para Remolque Para Remolque	39105	911533	■905910 ■907942	552001	—	—	—	—
		—	—	—	—	—	—	—	58654 MA834■
2005-07	4WD (1/2 Ton) 1500HD — Todos Crew Cab y Clásica Exc. c/ Control de Manejo Para Remolque	911181	911164	34504	34690	32350R	32341R	—	—
		—	—	—	—	—	—	—	58638■
2000-07	4WD (1/2 Ton) 1500 Todos — c/ ZX3 o c/ FW1 Sistema de Manejo Electrónico y Clásico Exc. Modelos HD	40038■	—	—	—	—	—	—	—
1999-07	4WD (1/2 Ton) 1500 Todos — Exc. 1500HD y c/ Control de Manejo Electrónico Monotubo para Alto Desempeño Para Remolque	911151 911501	911152 911502	34677	34678	32328R	32329R	—	—
		—	—	—	—	—	—	—	58637■

● Nuevo número de parte

R Monro-Matic Plus Reforzado

■ Número de parte bajo pedido especial



## APLICACIONES

### CHEVROLET — Pickup Silverado (Cont.)

1999-07 (Cont.)	4WD (1/2 Ton) 1500 Todos — c/ Paquete Off-Road Z71 Exc. HD y c/ Control de Manejo Elect.	911501	911502	—	—	—	—	—	—
2016-18	2WD (3/4 Ton) 2500HD — Todos c/ 10,000 lb. PBV	911447	—	34810	34811	—	—	—	—
2011-18	2WD (3/4 Ton) 2500HD — Todos c/ 9,200 lb. PBV	911447	911303	34810	34811	—	—	—	—
2000-10	2WD (3/4 Ton) 2500HD — Todos c/ 9,200 lb. PBV	911181	911164	34504	34690	32350R	32341R	—	—
1999-04	2WD (3/4 Ton) 2500 — Todos Hasta 8,600 lb. PBV Exc. c/ Paq. Quadrasteer Para Remolque	37163	37164 911164	34689	34690	32340R	32341R	—	—
2016-18	4WD (3/4 Ton) 2500HD — Todos c/ 10,000 lb. PBV	911447	911303	34810	34811	—	—	—	—
2011-18	4WD (3/4 Ton) 2500HD — Todos c/ 9,200 lb. PBV	911447	911303	34810	34811	—	—	—	—
2000-10	4WD (3/4 Ton) 2500HD — Todos c/ 9,200 lb. PBV	911181	911164	34504	34690	32350R	32341R	—	—
1999-04	4WD (3/4 Ton) 2500 — Todos Hasta 8,600 lb. PBV Exc. c/ Paq. Quadrasteer Para Remolque	911181	911164	34504	34690	32350R	32341R	—	—
2011-18	2WD (1 Ton) 3500HD — Chassis Cab	911447	—	34810	34812	—	—	—	—
	2WD (1 Ton) 3500HD — Exc. Chassis Cab	911447	911303	34810	34811	—	—	—	—
2001-10	2WD (1 Ton) 3500 — Todos c/ Susp. Delantera Independiente	911181	911168	34504	34694	32350R	32345R	—	—
1991-03	2WD (1 Ton) 3500HD — Todos c/ Eje de Viga Delantero en I	—	—	34755	34756	—	—	—	—
2011-18	4WD (1 Ton) 3500HD — Chassis Cab.	911447	—	34810	34812	—	—	—	—
	4WD (1 Ton) 3500HD — Exc. Chassis Cab.	911447	911303	34810	34811	—	—	—	—
2001-10	4WD (1 Ton) 3500 — Todos Inc. Chassis Cab.	911181	911168	34504	34694	32350R	32345R	—	—

### CHEVROLET — Pickup Silverado Amortiguador de Dirección

		Sin Soporte	Con Soporte
2011-16	2500 HD 3/4 Ton. 2WD — Reemplaza # OEM 25888044	SC2969	—
2011-15	2500 HD 3/4 Ton. 4WD — Reemplaza # OEM 25888044	SC2969	—
2000-10	2500 HD c/ Paq. 11,400lbs. PBV — Reemplaza # de E.O. 15059138 y 15155638 — Inc. Chassis Cab	SC2963	—
2011-15	3500 1 Ton. 2WD — Reemplaza # OEM 25888044	SC2969	—
2011-14	3500 1 Ton. 4WD — Reemplaza # OEM 25888044	SC2969	—
2001-10	3500 c/ Paq. 11,400lbs. PBV — Reemplaza # de E.O. 15059138 y 15155638 — Inc. Chassis Cab	SC2963	—
1992-96	Pickup 3500HD Series — Reemplaza # OEM 22064629	SC2956 <sup>34</sup>	

■ Número de parte bajo pedido especial

R Monro-Matic Plus Reforzado

<sup>34</sup> Juego de fuelle SA-19XX está disponible para el uso con nuestros cilindros de estabilizador de dirección.



## APLICACIONES

				BASES DE AMORTIGUADOR CUBREPOLVO		MONRO-MATIC HIDRÁULICO			

### CHEVROLET — S-10

1994-05	2WD — Todos Monotubo para Alto Desempeño	37129	37021	—	—	32300	32186	250300	250186
1982-93	2WD — Todos	37019 <sup>60</sup>	37021	—	—	32132	32186	250132	250186
1994-05	4WD Todos — Exc. c/ Paquete ZR2 Monotubo para Alto Desempeño	37099	37021	—	—	32194 1401	32186	250194	250186
		911514	911517	—	—	—	—	—	—
1994-03	4WD — Todos c/ Paquete ZR2	911514	—	—	—	—	—	—	—
1983-93	4WD — Todos	37099	37021	—	—	32194 1401	32186	250194	250186
	Monotubo para Alto Desempeño	911514	911517	—	—	—	—	—	—

### CHEVROLET — Sonic

2012-20	Todos	—	5520	902137● 63631	—	—	—	—	—
---------	-------	---	------	------------------	---	---	---	---	---

### CHEVROLET — Sonora

2001-06	4 Puertas 2WD y 4WD — Exc. c/ Paq. Z55 o c/ ZW7 Suspensión Autonivelable	911178	911166	34501	34692	32347R	32348R	—	—
	4 Puertas 2WD y 4WD — c/ Paq. Z55	40044	40034	—	—	—	—	—	—
	4 Puertas 2WD y 4WD — c/ Paq. ZW7 Suspensión Nivomat Auto Nivelable	911178	40210■	34501	—	32347R	—	—	—

### CHEVROLET — Spark

2017-22	Todos	—	5549●	— 63632	—	—	—	—	—
2016	Todos — Exc. EV	—	5549●	— 63632	—	—	—	—	—
2011-15	Todos								
	Derecho	73019	5537	902137●	—	—	—	—	—
	Izquierdo	73020	5537	902137●	—	—	—	—	—

### CHEVROLET — Spark Classic

2016-17	Todos								
	Derecho	73019	5537	—	—	—	—	—	—
	Izquierdo	73020	5537	—	—	—	—	—	—

### CHEVROLET — Suburban

2019	2WD (1/2 Ton) 1500 — LD Aislador Superior	39112	911506	902035 907942	—	—	—	—	—
2015-18	2WD (1/2 Ton) 1500 — Todos Exc. Z95 Magnetic Ride Control y Z85 Chasis de mayor capacidad Aislador Superior	39112	911506	902035 907942	—	—	—	—	—

● Nuevo número de parte

■ Número de parte bajo pedido especial

R Monro-Matic Plus Reforzado

<sup>60</sup> Aplicación especial : Este modelo NO necesita una capa debido a los espacios libres.



## APLICACIONES

		<b>GAS-MAGNUM®</b> BASES DE AMORTIGUADOR CUBREPOLVO		<b>MONRO-MATIC PLUS®</b> MONRO-MATIC® HIDRÁULICO		<b>ROADMATIC</b> LOAD ADJUSTING® MAX-AIR®	

### CHEVROLET — Suburban (Cont.)

2015-18 (Cont.)	2WD (1/2 Ton) 1500 — Todos c/ Z85 Chasis de mayor capacidad — Exc. Z95 Magnetic Ride Control Aislador Superior	39112	—	902035	—	—	—	—	—
		—	—	907942	—	—	—	—	—
2007-14	2WD (1/2 Ton) 1500 — Todos Exc. c/ Susp. Z55 y Susp. Nivomat Aislador Superior y Cubrepolvo	39104	911506	905910	—	—	—	—	—
		—	—	907942	—	—	—	—	—
	2WD (1/2 Ton) 1500 — Todos c/ Susp. Electrónica (Z55) y Rin de 22" Exc. Magnetic Ride Control (Z95)	40049	40052	—	—	—	—	—	—
2000-06	2WD (1/2 Ton) 1500 — Todos Exc. c/ Susp. Z55 y c/ Susp. Nivomat Monotubo para Alto Desempeño	911178	911166	34501	34692	32347R	32348R	—	—
		911505	911506	—	—	—	—	—	—
	2WD (1/2 Ton) 1500 — Todos c/ Susp. Z55	40044	40050	—	—	—	—	—	—
	2WD (1/2 Ton) 1500 — Todos c/ Susp. Nivomat — Exc. c/ Susp. Z55 Monotubo para Alto Desempeño	911178	40209■	34501	—	32347R	—	—	—
		911505	—	—	—	—	—	—	—
1995-99	2WD (1/2 Ton) 1500 — Todos	911178	911166	—	—	32347R	32348R	—	—
1987-91	2WD (1/2 Ton) R-1500 — Todos	37049	37041	34817	34824	1414	1415	—	—
1973-91	2WD (1/2 Ton) C-10 y R-10 — Todos	37049	37041	34817	34824	1414	1415	—	—
2001-13	2WD (3/4) 2500 — Todos c/ Susp. Delantera de Barra de Torsión — Exc. c/ Susp. Z55	911181	—	34504	—	32350R	—	—	—
2000-01	2WD (3/4 Ton) 2500 — Todos c/ Susp. Delantera de Resorte — Exc. c/ Susp. Z55	37163	—	34689	—	32340R	—	—	—
1992-99	2WD (3/4 Ton) 2500 — Todos — Exc. Modelos HD	911050	911085	34983	34762	32224R	32264R	250224	—
	2WD (3/4 Ton) 2500 — Todos Modelos HD y c/ 8,500 lb. PBV	911050	911085	34741	34762	32362R	32264R	—	—
2019	4WD (1/2 Ton) 1500 — LD Aislador Superior	39112	911506	902035	—	—	—	—	—
		—	—	907942	—	—	—	—	—
2015-18	4WD (1/2 Ton) 1500 — Todos Exc. Z95 Magnetic Ride Control y Z85 Chasis de mayor capacidad Aislador Superior	39112	911506	902035	—	—	—	—	—
		—	—	907942	—	—	—	—	—
	4WD (1/2 Ton) 1500 — c/ Z85 Chasis de mayor capacidad — Exc. Z95 Magnetic Ride Control Aislador Superior	39112	—	902035	—	—	—	—	—
		—	—	907942	—	—	—	—	—

■ Número de parte bajo pedido especial

R Monro-Matic Plus Reforzado



## APLICACIONES

	<b>OESpectrum</b>	<b>GAS-MAGNUM®</b>	<b>MONRO-MATIC PLUS®</b>		<b>ROADMATIC</b>	
	<b>Reflex</b>	<b>BASES DE AMORTIGUADOR</b> CUBREPOLVO	<b>MONRO-MATIC® HIDRÁULICO</b>		<b>LOAD ADJUSTING®</b> MAX-AIR®	

### CHEVROLET — Suburban (Cont.)

2007-14	4WD (1/2 Ton) 1500 Todos — Exc. c/ Susp. Z55 y c/ Susp. Nivomant Aislador Superior y Cubrepolvo	39104	911506	905910	—	—	—	—	—
		—	—	907942	—	—	—	—	—
	4WD (1/2 Ton) 1500 Todos — c/ Susp. Electrónica (Z55) y Rin de 22" — Exc. Magnetic Ride Control (Z95)	40049	40052	—	—	—	—	—	—
2000-06	4WD (1/2 Ton) 1500 Todos — Exc. c/ Susp. Z55 y c/ Susp. Nivomant Monotubo para Alto Desempeño	911178	911166	34501	34692	32347R	32348R	—	—
		911505	911506	—	—	—	—	—	—
	4WD (1/2 Ton) 1500 — Todos c/ Susp. Z55	40044	40050	—	—	—	—	—	—
	4WD (1/2 Ton) 1500 — Todos c/ Paquete Off—Road	911505	911506	—	—	—	—	—	—
1992-99	4WD (1/2 Ton) K-1500 — Todos c/ Paquete Off—Road	911511	—	—	—	—	—	—	—
	4WD (1/2 Ton) K-1500 — Todos Monotubo para Alto Desempeño	911043 911511	—	34798	34763	—	—	—	—
1973-91	4WD (1/2 Ton) 1500 Todos — Exc. c/ Susp. Quad	37040	37041	34944	34824	—	1415	—	—
1969-72	4WD (1/2 Ton) K-10 Series	37040	—	34944	34822	—	—	—	—
2000-13	4WD (3/4) 2500 Todos — Exc. c/ Susp. Z55 y c/ Paq. QuadraSteer	911181	911168	34504	34694	32350R	32345R	—	—
1992-99	4WD (3/4 Ton) 2500, K-2500 —Todos	911043	—	34798	34763	—	—	—	—
1973-91	4WD (3/4 Ton) 2500 Todos — Exc. c/ Susp. Quad	37040	37041	34944	34824	—	—	—	—
1969-72	4WD (3/4 Ton) 2500 — Todos	—	—	34944	34822	—	—	—	—

### CHEVROLET — Suburban Amortiguador de Dirección

		Sin Soporte	Con Soporte
1992-99	2WD y 4WD — Todos s/ Amortiguador de Dirección de E.O.	SC2914	—
1960-69	1/2 Ton 4WD — K10 Series	SC2917 <sup>[33]</sup> <sup>[34]</sup> <sup>[33]</sup> <sup>[34]</sup>	—
	3/4 Ton 4WD — K10 Series	SC2917 <sup>[33]</sup> <sup>[34]</sup> <sup>[33]</sup> <sup>[34]</sup>	—

### CHEVROLET — Trax

2013-22	Todos								
	Derecho	72934	5699	—	—	—	—	—	—
	Izquierdo	72935	5699	—	—	—	—	—	—

### CHEVROLET — Tahoe

2015-20	Patrulla	39140	911546■	902035	—	—	—	—	—
	Aislador Superior	—	—	907942	—	—	—	—	—

■ Número de parte bajo pedido especial

R Monro-Matic Plus Reforzado

[33] Se venden los cilindros como cilindros de repuesto para los juegos de estabilizador de dirección.

[34] Juego de fuelle SA-19XX está disponible para el uso con nuestros cilindros de estabilizador de dirección.



## APLICACIONES

		<b>GAS-MAGNUM®</b> BASES DE AMORTIGUADOR CUBREPOLVO		<b>MONRO-MATIC PLUS®</b> MONRO-MATIC® HIDRÁULICO		<b>ROADMATIC</b> LOAD ADJUSTING® MAX-AIR®	

### CHEVROLET — Tahoe (Cont.)

2015-18	Todos — Exc. Paq. Z95 Magnetic Ride Control, Patrulla y Paq. Z95 Chasis de Mayor Capacidad Aislador Superior	39112	911506	■902035	—	—	—	—	—
		—	—	■907942	—	—	—	—	—
	Todos — c/ Paq. Z85 Chasis de Mayor Capacidad — Exc. Paq. Z95 Magnetic Ride Control y Patrulla Aislador Superior	39112	—	■902035	—	—	—	—	—
		—	—	■907942	—	—	—	—	—
2007-14	4 Puertas 2WD y 4WD — Exc. c/ Paquete Z55 o c/ ZW7 Suspensión Autonivelable Aislador Superior y Cubrepolvo	39104	911506	■905910	—	—	—	—	—
		—	—	■907942	—	—	—	—	—
2001-06	4 Puertas 2WD y 4WD — Exc. c/ Paq. Z55 o c/ ZW7 Suspensión Autonivelable	911178	911166	34501	34692	32347R	32348R	—	—
	4 Puertas 2WD y 4WD — c/ Paq. Z55	40044	40034	—	—	—	—	—	—
	4 Puertas 2WD y 4WD — c/ Paq. ZW7 Suspensión Nivomat Auto Nivelable	911178	40210■	34501	—	32347R	—	—	—

### CHEVROLET — Tornado

2011-20	Todos	72994	37366	—	—	—	—	—	—
2004-10	Todos	—	—	906908	—	801050	33159	—	—
	Derecho Izquierdo	—	—	906908	—	801051	33159	—	—

### CHEVROLET — Tracker

2005-08	Todos	71590	—	—	—	—	—	—	—
	Derecho Izquierdo	71591	—	—	—	—	—	—	—
1998-04	Todos	71590	37070	—	—	—	32316	—	—
	Derecho Izquierdo	71591	37070	—	—	—	32316	—	—
	c/ Motor de 2.0 y 2.5 Litros	—	—	■904932	—	—	—	—	—
1998	Todos — c/ Frenos ABS	71590	37070	—	—	—	32316	—	—
	Derecho Izquierdo	71591	37070	—	—	—	32316	—	—
	Todos — Exc. c/ Frenos ABS	—	37070	—	—	—	32316	—	—
1989-92	Todos — Exc. c/ Frenos ABS	—	37070	—	—	—	32316	—	—

### CHEVROLET — Trailblazer

2002-09	2WD y 4WD — Todos c/ Susp. de Aire Trasera Para Remolque	71341	37242	■904968	—	—	—	—	—
		—	—	—	—	—	—	—	58644■
	2WD y 4WD — Todos c/ Susp. de Resorte Trasera	71341	37241	■904968	—	—	—	—	—

■ Número de parte bajo pedido especial

R Monro-Matic Plus Reforzado



## APLICACIONES

				BASES DE AMORTIGUADOR CUBREPOLVO		MONRO-MATIC HIDRÁULICO		LOAD ADJUSTING MAX-AIR	

### CHEVROLET — Traverse

2013-17	Todos	72949	37315	907986	—	—	33193	—	250020●
	Aislador de Resorte Superior	—	—	909923	—	—	—	—	—
	Aislador de Resorte Inferior	—	—	909924	—	—	—	—	—
	Para Remolque	—	—	—	—	—	—	—	MA833■
				63631					
2009-12	Todos	72518	37315	907986	—	—	33193	400018●	250020●
	Aislador de Resorte Superior	—	—	909923	—	—	—	—	—
	Aislador de Resorte Inferior	—	—	909924	—	—	—	—	—
	Para Remolque	—	—	—	—	—	—	—	MA833■
				63631					

### CHEVROLET — Uplander

2005-09	FWD — Exc. c/ Sist. Autonivelable de Aire y AWD	72231	37156	902973®	—	—	32333	—	—
	Aislador de Resorte Inferior	—	—	904943■	—	—	—	—	—
	Para Remolque	—	—	—	—	—	—	—	MA824
					63622				

### CHEVROLET — Van 1500 Express, Savana, Modelos G y P

2003-14	(1/2 Ton) 1500 Express, Savana, Modelos G Todos AWD — Inc. Sportvan, Rally y Vandura c/ Susp de Barra de Torsión Delantera	911256	911085	—	34762	—	32264R	—	—
	(1/2 Ton) 1500 Express, Savana, Modelos G Todos AWD — Inc. Sportvan, Rally y Vandura c/ Susp. de Resorte Delantera	911255	911085	—	34762	—	32264R	—	—
1996-02	(1/2) 1500 Express, Savana, Modelos G — Todos Inc. Sportvan, Rally y Vandura — Exc. c/ 8,600 lb. PBV	911050	911085	34983	34762	32224R	32264R	250224	—
1973-84	(1/2 Ton) P-10 Step Van Todos — Exc. Modelos HD	37049	37041	34817	34824	33033R 1414	33084R 1415	—	—
1967-72	(1/2 Ton) P-10 Step Van — Todos	37049	37040	34817	34944	33033R	—	—	—
1963-66	(1/2 Ton) P-10 Step Van — Todos	37049	—	34817	34803	33033R 1414	31000 1412	—	250001●
2003-18	(3/4 Ton) 2500 Express, Savana, Modelos G — Todos Inc. Sportvan, Rally y Vandura	911257	—	34530	34763	32362R	—	—	—
1996-02	(3/4 Ton) 2500 Express, Savana, Modelos G — Todos Inc. Sportvan, Rally y Vandura — Exc. c/ 8,600 lb. PBV	—	—	34741	34763	32362R	—	—	—
1978-95	(1/2 y 3/4 Ton) G—10, G—20 Express, Savana, Modelos G — Todos Inc. Sportvan, Rally y Vandura	—■	37091	34839	34910	—	33086R	—	—
1973-89	(3/4 Ton) P—20 Step Van — Todos Exc. Modelos HD	37049	37041	34817	34824	33033R 1414	33084R 1415	—	—
1968-72	(3/4 Ton) P—20 Step Van — Todos	37049	—	34817	34803	33033R	31000	—	250001●

- Nuevo número de parte
- Número de parte bajo pedido especial
- R Monro-Matic Plus Reforzado

® Este número de pieza es una marca registrada de Tenneco y no se puede usar ni reproducir sin permiso.



## APLICACIONES

	<b>OESpectrum</b>	<b>GAS-MAGNUM®</b>	<b>MONRO-MATIC PLUS®</b>		<b>ROADMATIC</b>			
	<b>Reflex</b>	■ BASES DE AMORTIGUADOR ● CUBREPOLVO	MONRO-MATIC® HIDRÁULICO		LOAD ADJUSTING® MAX-AIR®			

### CHEVROLET — Van 1500 Express, Savana, Modelos G y P (Cont.)

2003-08	(1 Ton) 3500 Express, Savana, Modelos G — Todos Inc. Sportvan, Rally y Vandura — Exc. Cutaway Van	911257	—	34530	34763	32362R	—	—	—
2009-15	(1 Ton) 3500 Cutaway Van — Todos c/ Resortes traseros pequeños	911257	—	34530	34532	32362R	—	—	—
1996-02	(1 Ton) 3500 Express, Savana, Modelos G — Todos Inc. Sportvan, Rally y Vandura — Exc. Doble Rodado Trasero	—	—	34741	34763	32362R	—	—	—
	(1 Ton) 3500 Express, Savana, Modelos G — Todos Inc. Sportvan, Rally y Vandura c/ Doble Rodado Trasero	—	—	34741	34756	32362R	—	—	—
1993-96	(1 Ton) 3500 HD Express, Savana, Modelos G — Todos c/ Susp. Delantera Independiente — Inc. Sportvan, Rally y Vandura	—	—	34736	—	32361R	—	—	—
1992-95	(1 Ton) G-30, G-3500 Express, Savana, Modelos G — Todos Inc. Sportvan, Rally y Vandura (G39)	—	—	34839	—	—	—	—	—
1979-95	(1 Ton) G-30, G-3500 Express, Savana, Modelos G — Todos Inc. Sportvan, Rally y Vandura c/ Doble Rodado Trasero	—	—	34839	—	—	—	—	—
1986-99	(1 Ton) P-30, P-3500 Step Van — Todos c/ Eje Delantero Recto	—	—	34912	34960	—	—	—	—

### CHEVROLET — Van 1500 Express, Savana, Modelos G y P Amortiguador de Dirección

		Sin Soporte	Con Soporte
1993-96	Van 30HD c/ Eje Delantero Recto (P42-P62) — Reemplaza # de E.O. 220644062 y 22046454	SC2913	—

### CHEVROLET — Van Express Cargo

2009-14	Todos	—	—	—	34531	32362R	—	—	—
---------	-------	---	---	---	-------	--------	---	---	---

### CHEVROLET — Van Cargo Van

1997-00	Todos	911050	911085	34983	34762	32224R	32264R	250224	—
---------	-------	--------	--------	-------	-------	--------	--------	--------	---

### CHEVROLET — Venture (Mini Van) AWD

2002-04	AWD	71661	—	■902973®	—	801661	—	—	—
	Aislador de Resorte Inferior	—	—	■904943■	—	—	—	—	—
1997-05	Todos — Exc. AWD c/ Sist. de Autonivelación Trasero	71661	37156	■902973®	—	801661	32333	—	—
	Aislador de Resorte Inferior	—	—	■904943■	—	—	—	—	—
	Para Remolque	—	—	—	—	—	—	—	MA824 <sup>[106]</sup>

■ Número de parte bajo pedido especial

R Monro-Matic Plus Reforzado

® Este número de pieza es una marca registrada de Tenneco y no se puede usar ni reproducir sin permiso.

<sup>[106]</sup> El kit del adaptador AK-29 se requiere para instalar esta unidad al adaptar amortiguadores de choque ajustables del aire a los vehículos sin sistema de nivelación posterior.





## APLICACIONES

### CHEVROLET — Zafira

2000-07	Todos	—	—	906908	—	801023	33154	—	—
	Derecho	—	—	906908	—	801024	33154	—	—
	Izquierdo	—	—	—	—	—	—	—	—

### CHRYSLER — 200

2015-17	Todos	72932	5514	—	—	—	—	—	—
	Derecho	72933	5514	—	—	—	—	—	—
	Izquierdo	—	—	—	—	—	—	—	—
2011-14	Sedán								
	Derecho	71130	71126	906958	906959	—	—	400010●	400023
	Izquierdo	71131	71126	906958	906959	—	—	400011●	400023
	Aislador de Resorte Superior	—	—	908983	—	—	—	—	—
				63631	63629				
	Convertible								
	Derecho	72332	—	906958	906959	—	—	—	—
	Izquierdo	72333	—	906958	906959	—	—	—	—
	Aislador de Resorte Superior	—	—	908983	—	—	—	—	—
				63631	63629				

### CHRYSLER — 300, 300C y 300M

2011-22	300 RWD — Exc. SRT	72665	5797	905966	905970	—	—	—	—
				63632					
	300 AWD	72899	5797	—	905970	—	—	—	—
				63632					
2005-10	300C AWD — Exc. c/ Suspensión Trasera Nivomat	72254	5612	—	905969	—	—	—	—
	Aislador de Resorte Inferior	—	—	906995■	—	—	—	—	—
	300C RWD — Exc. c/ Susp. Performance y Susp. Trasera Nivomat	72248	5797	905966	905969	802248	—	—	—
	Aislador de Resorte Inferior	—	—	906995■	—	—	—	—	—
	300C RWD c/ Susp. Performance — Exc. Susp. Trasera Nivomat	72408	5629	905966	905970	802248	33221●	—	—
	Aislador de Resorte Inferior	—	—	906995■	—	—	—	—	—
	300 RWD c/ Suspensión Trasera Nivomat — Exc. Susp. Performance	72248	40212	905966	905959	—	—	—	—
	Aislador de Resorte Inferior	—	—	906995■	—	—	—	—	—
1999-04	300M — Todos								
	Derecho	71667	71669	—	—	—	—	—	—
	Izquierdo	71668	71669	—	—	—	—	—	—
	Aislador de Resorte Superior	—	—	905989■	—	—	—	—	—
				63619	63618				

### CHRYSLER — AtoS

2000-12	Todos	72890	5695	—	—	—	—	401052	251022
	Derecho	72891	5695	—	—	—	—	401053	251022
	Izquierdo	—	—	—	—	—	—	—	—

### CHRYSLER — Cirrus

2007-10	Todos — Exc. Convertible	71130	71126	906958	906959	—	—	400010●	400023
	Derecho	71131	71126	906958	906959	—	—	400011●	400023
	Izquierdo	—	—	—	—	—	—	—	—
2001-06	Sedán y Convertible (JR)	71565 <sup>EL</sup>	71311 <sup>EL</sup>	901940 <sup>®</sup>	901940 <sup>®</sup>	801565	801311	—	—

● Nuevo número de parte

■ Número de parte bajo pedido especial

® Este número de pieza es una marca registrada de Tenneco y no se puede usar ni reproducir sin permiso.

EL Unidad Premium que son considerados con vástago de extensión lenta.

## APLICACIONES

	<b>OESpectrum</b>	<b>GAS-MAGNUM®</b>	<b>MONRO-MATIC PLUS®</b>		<b>ROADMATIC</b>			
	<b>Reflex</b>	BASES DE AMORTIGUADOR CUBREPOLVO	MONRO-MATIC® HIDRÁULICO		LOAD ADJUSTING® MAX-AIR®			

### CHRYSLER — Cirrus (Cont.)

2001-05	Coupé (ST)								
	Derecho	72147	71313	904957	902923	—	—	—	—
	Izquierdo	72148	71313	904957	902923	—	—	—	—
				63631	63636				
1999-00	Convertible (JX)	71565 <sup>EL</sup>	71311 <sup>EL</sup>	901940®	—	801565	801311	—	—
1996-98	Convertible (JX)	71897 <sup>EL</sup>	—	901940®	—	—	—	—	—

### CHRYSLER — Concorde

1998-04	Todos — Exc. R/T								
	Derecho	71667	71669	—	—	—	—	—	—
	Izquierdo	71668	71669	—	—	—	—	—	—
	Aislador de Resorte Superior	—	—	905989■	—	—	—	—	—
				63619	63618				
1993-97	Todos	—	—	—	—	—	—	—	—
				63619	63618				

### CHRYSLER — Dynasty

1988-93	Todos — c/ Sist. Automático de Nivelación Trasera	—	—	901908	—	—	—	—	—
	Asiento y Aislador de Resorte Superior	—	—	904916	—	—	—	—	—
				63620					
	Todos — Exc. c/ Sist. Autom. de Nivelación Trasera	—	5948	901908	—	—	—	—	—
	Asiento y Aislador de Resorte Superior	—	—	904916	—	—	—	—	—
				63620					

### CHRYSLER — H-100

2002-12	Todos	—	—	34793	34803	—	—	—	—
1981-83	Todos	5829	5837	—	—	31176	—	—	—

### CHRYSLER — LeBaron

1989-95	Coupé y Convertible — Exc. c/ Susp. Electrónica Ajustable	—	5962	901908	—	—	33095	—	—
	Asiento y Aislador de Resorte Superior	—	—	904916	—	—	—	—	—
				63621					
1989-94	Sedán ( 4 Puertas ) — Exc. c/ Susp. Elect. Ajustable	72589 <sup>RI</sup>	5962	901908	—	—	33095	—	—
	Asiento y Aislador de Resorte Superior	—	—	904916	—	—	—	—	—
				63621					
1977-81	Todos	5829	5837	—	—	—	—	—	—

### CHRYSLER — LHS

1998-01	Todos								
	Derecho	71667	71669	—	—	—	—	—	—
	Izquierdo	71668	71669	—	—	—	—	—	—
	Aislador de Resorte Superior	—	—	905989■	—	—	—	—	—
				63619	63618				
1994-97	Todos	—	—	—	—	—	—	—	—
				63619	63618				

■ Número de parte bajo pedido especial

® Este número de pieza es una marca registrada de Tenneco y no se puede usar ni reproducir sin permiso.

EL Unidad Premium que son considerados con vástago de extensión lenta.

RI Puede que se requiera el juego de piezas AK37 para reemplazar los tornillos y las tuercas originales del montaje inferior si están dañados o si no es posible reutilizarlos.



## APLICACIONES

		GAS-MAGNUM®		MONRO-MATIC PLUS®		ROADMATIC	
		BASES DE AMORTIGUADOR CUBREPOLVO		MONRO-MATIC® HIDRÁULICO		LOAD ADJUSTING® MAX-AIR®	

### CHRYSLER — New Yorker y Fifth Avenue

1988-93	New Yorker y Fifth Avenue - Exc. c/ Sist. Autonivelable de Aire Trasero	—	5948	☞901908	—	—	—	—	—
	Asiento y Aislador de Resorte Superior	—	—	☞904916	—	—	—	—	—
				☎63620					
1986-87	New Yorker y Fifth Avenue - Todos	72589 <sup>21</sup>	5962	☞901908	—	—	33095	—	—
	Asiento y Aislador de Resorte Superior	—	—	☞904916	—	—	—	—	—
				☎63622					
1984-85	New Yorker y Fifth Avenue - Todos	—	—	—	—	—	33095	—	—
				☎63622					

### CHRYSLER — Pacifica

2004-08	Todos	—	—	☞905911	—	802130	—	—	—
	Asiento de Resorte Superior	—	—	☞908959	—	—	—	—	—
	Aislador de Resorte Inferior	—	—	☞908958	—	—	—	—	—
				☎63632					

### CHRYSLER — PT Cruiser

2001-10	Wagon y Convertible	71592	5989	—	—	—	—	—	—
				☎63619					

### CHRYSLER — Sebring

2007-10	Todos — Exc. AWD y Convertible								
	Derecho	71130	71126	☞906958	☞906959	—	—	400010●	400023
	Izquierdo	71131	71126	☞906958	☞906959	—	—	400011●	400023
2001-06	Sedán y Convertible	71565 <sup>EL</sup>	71311 <sup>EL</sup>	☞901940 <sup>®</sup>	☞901940 <sup>®</sup>	801565	801311	—	—
2001-05	Coupe								
	Derecho	72147	71313	☞904957	☞902923	—	—	—	—
	Izquierdo	72148	71313	☞904957	☞902923	—	—	—	—
	Plato de Montura	—	—	—	☞909947	—	—	—	—
	Aislador de Resorte Superior	—	—	—	909969■	—	—	—	—
				☎63631	☎63636				

### CHRYSLER — Stratus

1995-97	Todos	71897 <sup>EL</sup>	—	☞901940 <sup>®</sup>	—	—	—	—	—
---------	-------	---------------------	---	----------------------	---	---	---	---	---

### CHRYSLER — Town & Country

2012-16	Todos — Suspensión de Alto Desempeño Exc. c/ Susp. Nivomat	72780	37290	☞906960	—	—	—	—	—
	Para Remolque	—	—	—	—	—	—	—	58648
				☎63631					
	Todos — Exc. c/ Susp. Nivomat o c/. Susp. de Alto Desempeño	71128	37290	☞906960	—	—	—	—	—
	Kit de Conversión	—	90020C■	—	—	—	—	—	—
	Para Remolque	—	—	—	—	—	—	—	58648
2008-11	Todos — Exc. c/ Susp. Nivomat	71128	37290	☞906960	—	—	—	—	—
	Para Remolque	—	—	—	—	—	—	—	58648

● Nuevo número de parte

■ Número de parte bajo pedido especial

® Este número de pieza es una marca registrada de Tenneco y no se puede usar ni reproducir sin permiso.

EL Unidad Premium que son considerados con vástago de extensión lenta.

21 Puede que se requiera el juego de piezas AK37 para reemplazar los tornillos y las tuercas originales del montaje inferior si están dañados o si no es posible reutilizarlos.



## APLICACIONES

	<b>OESpectrum</b>	<b>GAS-MAGNUM®</b>	<b>MONRO-MATIC PLUS®</b>	<b>ROADMATIC</b>
	<b>Reflex</b>	BASES DE AMORTIGUADOR CUBREPOLVO	MONRO-MATIC® HIDRÁULICO	LOAD ADJUSTING® MAX-AIR®

### CHRYSLER — Town & Country (Cont.)

2001-07	Todos — Exc. AWD y c/ Susp. Trasera Nivomat	71572 <sup>[89]</sup>	37123	905911	—	801572	32290	400022●	250290
	Aislador de Resorte Superior	—	—	905972 63619	—	—	—	—	—
	Todos — Todos AWD	71572 <sup>[89]</sup>	—	905911	—	801572	—	400022●	—
	Aislador de Resorte Superior	—	—	905972 63619	—	—	—	—	—
2001-05	Todos — c/ Susp. Trasera Nivomat — Exc. AWD	71572 <sup>[89]</sup>	40201	905911	—	801572	—	400022●	—
				63619					
Mar 1995-00	Todos — c/ Susp. Trasera Nivomat	71964 <sup>[89]</sup>	—	902945	—	—	—	400964	—
				63620					
	Todos — Exc. c/ Susp. Trasera Nivomat	71964 <sup>[89]</sup>	37123	902945	—	801964 <sup>[89]</sup>	32290	400964	250290
				63620					
1990-Feb 95	Todos — Todos Asiento y Aislador de Resorte Superior	72591 <sup>[21]</sup>	37065	901908	—	—	32233	—	—
		—	—	904916	—	—	—	—	—
				63620					

### CHRYSLER — Verna

2000-06	Sedán y Coupé								
	Derecho	71400	71584	903938	903939	—	—	—	—
	Izquierdo	—	—	903938	903939	—	—	—	—
	Aislador de Resorte Inferior	—	—	—	906936■	—	—	—	—
				63619	63619				

### CHRYSLER — Voyager y Grand Voyager

2012-16	Voyager y Grand Voyager — Exc. c/ Susp. Nivomat Para Remolque	71128	37290	906960	—	—	—	—	—
		—	—	—	—	—	—	—	58648
2001-07	Voyager y Grand Voyager — Todos c/ Motor de 4 Cil. Exc. AWD y c/ Susp. Trasera Nivomat	71572 <sup>[89]</sup>	37123	905911	—	801572	32290	400022●	250290
	Aislador de Resorte Superior	—	—	905972 63619	—	—	—	—	—
Mar 1995-00	Voyager y Grand Voyager — Todos c/ Susp. Trasera Nivomat	71964 <sup>[89]</sup>	—	902945	—	801964 <sup>[89]</sup>	—	400964	—
				63620					
	Voyager y Grand Voyager — Todos Exc. c/ Susp. Trasera Nivomat	71964 <sup>[89]</sup>	37123	902945	—	801964 <sup>[89]</sup>	32290	400964	250290
				63620					
1986-94	Voyager y Grand Voyager — Todos	72591 <sup>[21]</sup>	37065	901908	—	—	32233	—	—
	Asiento y Aislador de Resorte Superior	—	—	904916	—	—	—	—	—
				63620					
1984-85	Voyager y Grand Voyager — Todos	—	37065	—	—	—	32233	—	—
				63620					

● Nuevo número de parte

■ Número de parte bajo pedido especial

[21] Puede que se requiera el juego de piezas AK37 para reemplazar los tornillos y las tuercas originales del montaje inferior si están dañados o si no es posible reutilizarlos.

[89] Puede que se requiera el juego de piezas AK71 para reemplazar los tornillos y las tuercas originales del montaje inferior si están dañados o si no es posible reutilizarlos.



## APLICACIONES

	<b>OESpectrum</b>	<b>GAS-MAGNUM®</b>		<b>MONRO-MATIC PLUS®</b>		<b>ROADMATIC</b>	
	<b>Reflex</b>	<b>BASES DE AMORTIGUADOR</b>		<b>MONRO-MATIC® HIDRÁULICO</b>		<b>LOAD ADJUSTING</b>	
		<b>CUBREPOLVO</b>				<b>MAX-AIR®</b>	

### CHRYSLER — Voyager y Grand Voyager (Cont.)

1974-83	Voyager PB—100, PB—150, PB—200, PB—250 Van (1/2 y 3/4 Ton) — Todos	37096	37091	34831	34910	—	—	—	—
	Voyager PB—300, PB—350 Van (1 Ton) — Todos c/ Eje Delantero de 4,000 lb.	—	—	34868	34910	—	—	—	—

### DINA — 1000, 3000

1978-86	D—1000, 3000, 3200 — Todos	—	—	—	—	33033R 1414	33084R 1415	—	—
1985-90	D—3000, 3130 y C—3130 Todos	—	—	34736	34803	33033R 1414	31000 1412	—	250001●

### DODGE — 400

1983	Todos	—	—	Ⓞ63619	—	—	33095	—	—
------	-------	---	---	--------	---	---	-------	---	---

### DODGE — 600

1986-88	Todos	—	—	Ⓜ901908	—	—	33095	—	—
	Asiento y Aislador de Resorte Superior	—	—	Ⓜ904916	—	—	—	—	—
		—	—	Ⓞ63622	—	—	—	—	—
1984- Dic 85	Todos	—	—	—	—	—	33095	—	—
		—	—	Ⓞ63622	—	—	—	—	—
1983	Todos	—	—	Ⓞ63619	—	—	33095	—	—

### DODGE — Aries

1986-89	Todos	—	—	Ⓜ901908	—	—	33095	—	—
	Asiento y Aislador de Resorte Superior	—	—	Ⓜ904916	—	—	—	—	—
		—	—	Ⓞ63622	—	—	—	—	—
1984- Dic 85	Todos	—	—	—	—	—	33095	—	—
		—	—	Ⓞ63622	—	—	—	—	—
1983	Todos	—	—	—	—	—	33095	—	—
		—	—	Ⓞ63619	—	—	—	—	—

### DODGE — Aspen

2006-09	2WD y 4WD — Exc. Híbrido Para Remolque	911259	911260	—	—	32405	32406	—	—
		—	—	—	—	—	—	—	58651
1976-80	Todos	5829	5837	—	—	31176	—	—	—

### DODGE — Attitude

2012-14	Todos	—	—	—	—	—	—	—	—
	Derecho	72706	5672■	Ⓜ902036	—	—	—	—	—
	Izquierdo	72707	5672■	Ⓜ902036	—	—	—	—	—
		—	—	Ⓞ63632	—	—	—	—	—
2006-11	Todos	—	—	—	—	—	—	—	—
	Derecho	72297	5621	Ⓜ906969	Ⓜ906971	—	33209●	400030	250021●
	Izquierdo	72298	5621	Ⓜ906970	Ⓜ906971	—	33209●	400031	250021●

### DODGE — Avenger

2007-14	Todos — Exc. AWD	—	—	—	—	—	—	—	—
	Derecho	71130	71126	Ⓜ906958	Ⓜ906959	—	—	400010●	400023
	Izquierdo	71131	71126	Ⓜ906958	Ⓜ906959	—	—	400011●	400023

● Nuevo número de parte

R Monro-Matic Plus Reforzado

■ Número de parte bajo pedido especial



## APLICACIONES

		<b>GAS-MAGNUM®</b> BASES DE AMORTIGUADOR CUBREPOLVO		<b>MONRO-MATIC PLUS®</b> MONRO-MATIC® HIDRÁULICO		<b>ROADMATIC</b> LOAD ADJUSTING® MAX-AIR®	

### DODGE — Caliber

2007-12	Todos — Exc. Modelo SRT-4								
	Derecho	72367	72401 <sup>EL</sup>	907994	906959	—	—	400034●	400033●
	Izquierdo	72368	72401 <sup>EL</sup>	907994	906959	—	—	400035●	400033●
	Aislador de Resorte Superior	—	—	908970	—	—	—	—	—

### DODGE — Caravan y Grand Caravan

2014-20	Caravan y Grand Caravan SE y SXT — Exc. c/ Susp. Nivomat Trasera	71128	37290	906960	—	—	—	—	—
	Aislador de Resorte Superior	—	—	—	—	—	—	—	—
	Aislador de Resorte Inferior	—	—	—	—	—	—	—	—
	Para Remolque	—	—	—	—	—	—	—	58648
				63631					
	Caravan y Grand Caravan SE y SXT — c/ Susp. Nivomat Trasera	71128	—	906960	—	—	—	—	—
				63631					
2017	Caravan y Grand Caravan GT — Exc. c/ Susp. Trasera Nivomat Para Remolque	72780	37290	906960	—	—	—	—	—
		—	—	—	—	—	—	—	58648
				63631					
	Caravan y Grand Caravan GT — c/ Susp. Trasera Nivomat	72780	—	906960	—	—	—	—	—
				63631					
2012-16	Caravan y Grand Caravan — R/T Exc. c/ Susp. Trasera Nivomat Para Remolque	72780	37290	906960	—	—	—	—	—
		—	—	—	—	—	—	—	58648
				63631					
	Caravan y Grand Caravan — S/T c/ Susp. Trasera Nivomat	72780	—	906960	—	—	—	—	—
				63631					
2013	Caravan y Grand Caravan — Crew, SE y SXT — Exc. c/ Susp. Nivomat Trasera Para Remolque	71128	37290	906960	—	—	—	—	—
		—	—	—	—	—	—	—	58648
				63631					
	Caravan y Grand Caravan — Crew, SE y SXT — c/ Susp. Nivomat Trasera	71128	—	906960	—	—	—	—	—
				63631					
2010-15	Caravan y Grand Caravan — Todos Kit de Conversión	—	90020C■	—	—	—	—	—	—
2008-12	Caravan y Grand Caravan — Todos								
2008-11	Caravan y Grand Caravan Todos — Exc. c/ Susp. Nivomat Para Remolque	71128	37290	906960	—	—	—	—	—
		—	—	—	—	—	—	—	58648
2008-09	Caravan y Grand Caravan — Todos								
2001-07	Caravan Todos — Exc. AWD y c/ Susp. Trasera Nivomat Asiento de Resorte Superior	71572 <sup>Ⓢ</sup>	37123	905911	—	801572	32290	400022●	250290
		—	—	905972	—	—	—	—	—
				63619					

● Nuevo número de parte

■ Número de parte bajo pedido especial

EL Unidad Premium que son considerados con vástago de extensión lenta.

Ⓢ Puede que se requiera el juego de piezas AK71 para reemplazar los tornillos y las tuercas originales del montaje inferior si están dañados o si no es posible reutilizarlos.



## APLICACIONES

		 BASES DE AMORTIGUADOR CUBREPOLVO	 MONRO-MATIC HIDRÁULICO	 LOAD ADJUSTING MAX-AIR

### DODGE — Caravan y Grand Caravan (Cont.)

2001-07 (Cont.)	Caravan — AWD	71572 <sup>[8]</sup>	—	905911	—	801572	—	400022●	—
	Asiento de Resorte Superior	—	—	905972	—	—	—	—	—
	Caravan — c/ Susp. Nivomat	71572 <sup>[8]</sup>	40201	905911	—	801572	—	400022●	—
	Exc. AWD Asiento de Resorte Superior	—	—	905972	—	—	—	—	—
Mar 1995-00	Caravan — Todos Exc. c/ Susp. Trasera Nivomat	71964 <sup>[8]</sup>	37123	902945	—	801964 <sup>[8]</sup>	32290	400964	250290
1986- Feb 95	Caravan — Todos Asiento y Aislador de Resorte Superior	72591 <sup>[21]</sup>	37065	901908	—	—	32233	—	—
				904916	—	—	—	—	—
				63622					

### DODGE — Challenger

2020-22	GT, R/T, SXT — Exc. AWD, Paquete R/T Scat y Susp. Sport Aislador de Resorte Inferior	72665	5797	905966	905970	—	—	—	—
				906995■	—	—	—	—	—
				63632					
2011-19	RWD — Exc. Susp. Electrónica o Performance Aislador de Resorte Inferior	72665	5797	905966	905970	—	—	—	—
				906995■	—	—	—	—	—
				63632					
2009-10	Todos — RT y SRT8	72248	—	905966	905970	802248	—	—	—
				906995■	—	—	—	—	—
				63632					
	Todos — SE y SXT	72248	5629	905966	905969	802248	33221●	—	—
				906995■	—	—	—	—	—
				63632					
2008	Todos — Todos	72248	—	905966	905970	802248	—	—	—
				906995■	—	—	—	—	—
				63632					
1970-74	Todos — Todos	—	—	—	—	32022	32073	—	—

### DODGE — Charger

2011-22	RWD — Exc. Susp. HD, Susp. Trasera Nivomat, Modelos SRT y Patrulla	72665	5797	905966	905970	—	—	—	—
				906995■	—	—	—	—	—
				63632					
	RWD — Kit de Conversión	—	90029C●	—	—	—	—	—	—
	AWD — Exc. GT, Enforcer, SXT Plus	72899	5797	—	905970	—	—	—	—
				63632					
	RWD — Patrulla	—	40212	553014 <sup>[21]</sup>	905970	—	—	—	—
				905966	—	—	—	—	—
				63632					
2014-22	AWD — Patrulla	—	40212	553033●	905970	—	—	—	—
				63632					
2006-10	AWD — Exc. Suspensión Nivomat Aislador de Resorte Inferior	72254	5612	—	905969	—	—	—	—
				906995■	—	—	—	—	—
				63632					
	RWD y c/ Suspensión Nivomat Aislador de Resorte Inferior	72248	40212	905966	905970	802248	—	—	—
				906995■	—	—	—	—	—
				63632					

● Nuevo número de parte

■ Número de parte bajo pedido especial

[21] Puede que se requiera el juego de piezas AK37 para reemplazar los tornillos y las tuercas originales del montaje inferior si están dañados o si no es posible reutilizarlos.

[8] Puede que se requiera el juego de piezas AK71 para reemplazar los tornillos y las tuercas originales del montaje inferior si están dañados o si no es posible reutilizarlos.



## APLICACIONES

		<b>GAS-MAGNUM®</b> BASES DE AMORTIGUADOR CUBREPOLVO		<b>MONRO-MATIC PLUS®</b> MONRO-MATIC® HIDRÁULICO		<b>ROADMATIC</b> LOAD ADJUSTING® MAX-AIR®	

### DODGE — Charger (Cont.)

2006-10 (Cont.)	RWD — Exc. c/ Suspensión Nivomat	72248	5797	905966	905969	802248	—	—	—
	Aislador de Resorte Inferior	—	—	906995■	—	—	—	—	—
	RWD c/ Susp. Performance — Exc. c/ Suspensión Nivomat y Patrulla	72408	5629	905966	905969	—	33221●	—	—
	Aislador de Resorte Inferior	—	—	906995■	—	—	—	—	—
	RWD — Kit de Conversión	—	90029C●	—	—	—	—	—	—
1973-76	Todos	—	—	—	—	32134■	32073	—	—
1966-72	Todos	—	—	—	—	32022	32073	—	—

### DODGE — Coronet

1973-76	Todos	—	—	—	—	32134■	32073	—	—
1962-72	Todos	—	—	—	—	32022	32073	—	—

### DODGE — Dakota

2010 - 12	2WD y 4WD Pickup — Todos	72517	911277	905914	—	—	—	—	—
		—	—	908962	—	—	—	—	—
2009	2WD y 4WD Pickup Todos — Inc. Club Cab	71100	911277	905914	—	—	—	—	—
		—	—	908962	—	—	—	—	—
2006-08	2WD y 4WD Pickup Todos — Inc. Club Cab	71100	911277	905914	—	—	—	—	—
		—	—	907971	—	—	—	—	—
2005	2WD y 4WD Pickup Todos — Inc. Club Cab	71100	911277	905913	—	—	—	—	—
		—	—	907971	—	—	—	—	—
1997-04	2WD Pickup Todos — Inc. Club Cab	37137	37138	34785	34786	32318	32319	—	—
1987-96	2WD Pickup Todos — Inc. Club Cab	37066	37067	—	—	32214	32215	—	—
1997-04	4WD Pickup Todos — Inc. Club Cab	911220	911140	34790	34789	32250	32321	—	—
1987-96	4WD Pickup Todos — Inc. Club Cab	—	—	34790	—	32250	32251	—	—

### DODGE — Dart

2015-16	Todos — Exc. GT								
	Derecho	72641 [1170]	5827	909986	—	—	33216●	—	—
	Izquierdo	72642 [1170]	5827	909987	—	—	33216●	—	—
	Aislador de Resorte Superior	—	—	909988	—	—	—	—	—
	Aislador de Resorte Inferior	—	—	909989	—	—	—	—	—
				63631					
	GT								
	Derecho	72641 [1170]	5827	—	—	—	33216●	—	—
	Izquierdo	72642 [1170]	5827	—	—	—	33216●	—	—
	Aislador de Resorte Inferior	—	—	909989	—	—	—	—	—
				63631					

● Nuevo número de parte

■ Número de parte bajo pedido especial





## APLICACIONES

### DODGE — Dart (Cont.)

2013-14	Todos								
	Derecho	72641	5827	909986	—	—	33216 ●	—	—
	Izquierdo	72642	5827	909987	—	—	33216 ●	—	—
	Aislador de Resorte Superior	—	—	909988	—	—	—	—	—
	Aislador de Resorte Inferior	—	—	909989	—	—	—	—	—
				63631					
1977-89	Todos	5829	5837	—	—	31176	—	—	—
1963-76	Todos	—	—	—	—	32022	31131	—	—

### DODGE — Daytona

1989-93	Todos — Exc. IROC	—	5962	901908	—	—	33095	—	—
	Asiento y Aislador de Resorte Superior	—	—	904916	—	—	—	—	—
				63621					
1986-88	Todos	—	5962	901908	—	—	33095	—	—
	Asiento y Aislador de Resorte Superior	—	—	904916	—	—	—	—	—
				63622					
1984-Dic 85	Todos	—	—	—	—	—	33095	—	—
				63622					

### DODGE — Diplomat

1979-89	Todos	5829	5837	—	—	—	—	—	—
---------	-------	------	------	---	---	---	---	---	---

### DODGE — Durango

2016-22	Todos — Exc. SRT, Special Service, Patrulla, Susp. Sport y Susp. de Nivelación de carga.	—	911304	—	—	—	—	—	—
2011-15	Todos — Exc. Susp. Trasera Nivomat	72546	911304	902053 ●	—	—	—	—	—
2011-16	Todos — c/ Susp. Trasera Nivomat	72546	—	902053 ●	—	—	—	—	—
2004-09	2WD — Todos Para Remolque	911259	911260	—	—	32405	32406	—	—
		—	—	—	—	—	—	—	58651
1999-03	2WD — Todos	37137	37138	34785	34786	32318	32319	—	—
2004-09	4WD — Todos Para Remolque	911259	911260	—	—	—	—	—	—
		—	—	—	—	—	—	—	58651
1998-03	4WD — Todos	911220	911140	34790	34789	32250	32321	—	—

### DODGE — i10

2012-14	Todos								
	Derecho	71061	5510	—	—	—	—	—	—
	Izquierdo	71062	5510	—	—	—	—	—	—

### DODGE — Intrepid

1998-04	Todos — Exc. Modelo R/T								
	Derecho	71667	71669	—	—	—	—	—	—
	Izquierdo	71668	71669	—	—	—	—	—	—
	Aislador de Resorte Superior	—	—	905989 ■	—	—	—	—	—
				63619	63618				
1993-97	Todos	—	—	63619	63618	—	—	—	—

● Nuevo número de parte

■ Número de parte bajo pedido especial



## APLICACIONES

### DODGE — Journey

2020	Todos	—	72896	🚗908984	902054●	—	802896	—	—
2011-19	Todos	—	—	—	—	—	—	—	—
	Derecho	72509	72896	🚗908984	902054●	—	802896	—	—
	Izquierdo	72510	72896	🚗908984	902054●	—	802896	—	—
2009-10	AWD — Exc. Susp. Auto Nivelable	—	—	—	—	—	—	—	—
	Derecho	72509	72895	🚗908984	🚗907995	—	—	—	—
	Izquierdo	72510	72895	🚗908984	🚗907995	—	—	—	—
	Aislador de Resorte Superior	—	—	🚗908983	—	—	—	—	—
					🔧63631				
	FWD — Base y SE sin Paquete Appearance — Exc. Susp. Auto Nivelable	—	—	—	—	—	—	—	—
	Derecho	72509	72894	🚗908984	🚗907995	—	—	—	—
	Izquierdo	72510	72894	🚗908984	🚗907995	—	—	—	—
	Aislador de Resorte Inferior	—	—	🚗908984	—	—	—	—	—
					🔧63631				
	FWD — Base, Crew, R/T, SXT & SE — Exc. Susp. Auto Nivelable	—	—	—	—	—	—	—	—
	Derecho	72509	72511	🚗908984	🚗907995	—	—	—	—
Izquierdo	72510	72511	🚗908984	🚗907995	—	—	—	—	
Aislador de Resorte Inferior	—	—	🚗908984	—	—	—	—	—	
				🔧63631					

### DODGE — Lancer

1986-89	Todos	—	—	🚗901908	—	—	33095	—	—
	Asiento y Aislador de Resorte Superior	—	—	🚗904916	—	—	—	—	—
					🔧63622				
1985-Dic 85	Todos	—	—	—	—	—	33095	—	—
							🔧63622		

### DODGE — Magnum

1978-79	Todos	—	5837	—	—	32134■	—	—	—
---------	-------	---	------	---	---	--------	---	---	---

### DODGE — Mónaco

1974-76	Todos	—	—	—	—	31176	32073	—	—
---------	-------	---	---	---	---	-------	-------	---	---

### DODGE — Neón

2000-05	Todos — Exc. Modelo SRT4	71580	—	—	—	801580	—	—	—
				🔧63619	🔧63619				
1995-99	Todos	—	—	—	—	—	—	—	—
				🔧63619	🔧63621				

### DODGE — Nitro

2007-12	Todos	—	—	—	—	—	—	—	—
	Derecho	71577	37203	🚗905902	—	—	—	400007	250013●
	Izquierdo	71577	37203	🚗905903	—	—	—	400007	250013●

### DODGE — Pickup Ram 1500

2009-10	2WD (1/2 Ton) Ram 1500 — Exc. Tradesman HD Para Remolque	911300	911299	34800	34795 550060	—	—	—	—
		—	—	—	—	—	—	—	MA837

● Nuevo número de parte

■ Número de parte bajo pedido especial



## APLICACIONES

### DODGE — Pickup Ram 1500 (Cont.)

2006-08	2WD (1/2 Ton) Ram 1500 Mega Cab Exc. SRT—10 Para Remolque	911221	911222	34520	34521	—	—	—	—
		—	—	—	—	—	—	—	MA837
2002-08	2WD (1/2 Ton) Ram 1500 Todos — Exc. SRT—10 y Mega Cab Para Remolque	911186	911187	34514	34515	32390R	32391R	—	—
		—	—	—	—	—	—	—	MA837
1994-01	2WD (1/2 Ton) Ram 1500 — Todos	—	—	34776	34777	32277R	32278R	250017●	250018●
2013-17	4WD Ram 1500 — c/ Suspension de Aire Exc. Off Road Suspension	—	911197	—	—	—	—	—	—
2019	4WD (1/2 Ton) Ram 1500 Classic — Exc. Susp. de Aire Kit de Bujes de Brazo de Control de la Susp. Asiento de Resorte Superior Para Remolque	72292	911299	907930	34795 550060	—	—	—	—
		—	—	908962	—	—	—	—	—
		—	—	907931	—	—	—	—	—
		—	—	—	—	—	—	—	MA837
2009-18	4WD (1/2 Ton) Ram 1500 — Exc. Susp. de Aire Kit de Bujes de Brazo de Control de la Susp. Asiento de Resorte Superior Para Remolque	72292	911299	907930	34795 550060	—	—	—	—
		—	—	908962	—	—	—	—	—
		—	—	907931	—	—	—	—	—
		—	—	—	—	—	—	—	MA837
2006-08	4WD (1/2 Ton) Ram 1500 — Exc. MegaCab Para Remolque	71111	911187	905914	34515	—	32391R	—	—
		—	—	907971	—	—	—	—	MA837
2002-05	4WD (1/2 Ton) Ram 1500 — Todos Para Remolque	—	911187	34516	34515	32392R	32391R	—	—
		—	—	—	—	—	—	—	MA837
1994-01	4WD (1/2 Ton) Ram 1500 — Todos	—	—	34778	34777	32279R	32278R	—	250018●

### DODGE — Pickup Ram 1500 Amortiguador de Dirección

		Sin Soporte	Con Soporte
2000-07	4WD — Reemplaza # de E.O. 52106909AB, AC, AD y AE	SC2964	—
1994-97	4WD — Reemplaza # de E.O. 52038276	SC2953	—
1997-99	4WD — Reemplaza # de E.O. 52039280	SC2960	—

### DODGE — Pickup Ram 2500

2014-22	2WD (3/4 Ton) Ram 2500 — Exc. Susp. De Aire	911198	911336	34534	—	—	—	—	—
2003-10	2WD (3/4 Ton) Ram 2500 — Todos	911221	911222	34520	34521	—	—	—	—
1994-02	2WD (3/4 Ton) Ram 2500 — Todos Exc. c/ 8,800 lb PBV	—	—	34776	34777	32277R	32278R	250017●	250018●
	2WD (3/4 Ton) Ram 2500 — Todos c/ 8,800 lb PBV	911191	—	34776	34777	32277R	32278R	250017●	250018●
2014-22	4WD (3/4 Ton) Ram 2500 — Todos Exc. Power Wagon	911198	911336	34534	—	—	—	—	—
2014-16	4WD (3/4 Ton) Ram 2500 — Todos Power Wagon	911198	—	34534	—	—	—	—	—
2003-13	4WD (3/4 Ton) Ram 2500 — Todos Exc. Power Wagon	911223	911222	34522	34521	—	—	—	—
1994-02	4WD (3/4 Ton) Ram 2500 — Todos Exc. c/ 8,800 lb. PBV	—	—	34778	34777	32279R	32278R	—	250018●
	4WD (3/4 Ton) Ram 2500 — Todos c/ 8,800 lb. PBV	911193	911192	34782	34781	32366R	32365R	—	—

● Nuevo número de parte

R Monro-Matic Plus Reforzado



## APLICACIONES

### DODGE — Pickup Ram 2500 Amortiguador de Dirección

		Sin Soporte	Con Soporte
2009-13	4WD	SC2968	—
2000-07	4WD — Reemplaza # de E.O. 52106909AB, AC, AD y AE	SC2964	—
1994-97	4WD — Reemplaza # de E.O. 52038276	SC2953	—
1997-99	4WD — Reemplaza # de E.O. 52039280	SC2960	—

### DODGE — Pickup Ram 3500

2013-22	2WD (1 Ton) Ram 3500 — Todos Exc. Chassis Cab y Susp. De Aire Trasera	911198	911199	—	—	—	—	—	—
2014-22	2WD (1 Ton) Ram 3500 — Todos Chassis y Cab c/ Doble rodado trasero — Exc. Susp. De Aire	—	—	34814■	34816■	—	—	—	—
	2WD (1 Ton) Ram 3500 — Todos Chassis y Cab c/ Ruedas traseras simples — Exc. Susp. De Aire	—	—	34814■	34815■	—	—	—	—
2011-13	2WD (1 Ton) Ram 3500 — Todos Chassis y Cab c/ Doble rodado trasero y Ruedas traseras simples	—	—	34813	—	—	—	—	—
2007-13	2WD (1 Ton) Ram 3500 — Series Chassis Cab	911223	—	34522	34529	—	—	—	—
2003-10	2WD (1 Ton) Ram 3500 — Todos Exc. Chassis Cab	911221	911222	34520	34521	—	—	—	—
1994-02	2WD (1 Ton) Ram 3500 — Todos c/ Susp. Delantera Independiente	911191	911192	34776	34781	32277R	32365R	250017●	—
	2WD (1 Ton) Ram 3500 — Todos c/ Eje Delantero Solido	911193	911192	34782	34781	32366R	32365R	—	—
	2WD (1 Ton) Ram 3500 — Todos Exc. Chassis Cabina	911191	—	34776	34777	32277R	32278R	250017●	250018●
2013-22	4WD (1 Ton) Ram 3500 — Todos Exc. Chassis Cab y Susp. De Aire Trasera	911198	911199	—	—	—	—	—	—
2014-22	4WD (1 Ton) Ram 3500 — Todos Chassis y Cab c/ Doble rodado trasero — Exc. Susp. De Aire	—	—	34814■	34816■	—	—	—	—
	4WD (1 Ton) Ram 3500 — Todos Chassis y Cab c/ Ruedas traseras simples — Exc. Susp. De Aire	—	—	34814■	34815■	—	—	—	—
2011-13	4WD (1 Ton) Ram 3500 — Todos Chassis y Cab c/ Doble rodado trasero y Ruedas traseras simples	—	—	34813	—	—	—	—	—
2007-11	4WD (1 Ton) Ram 3500 — Chassis Cab	911223	—	34522	—	—	—	—	—
2003-12	4WD (1 Ton) Ram 3500 — Todos Exc. Chassis Cab	911223	911222	34522	34521	—	—	—	—
1994-02	4WD (1 Ton) Ram 3500 — Todos	911193	911192	34782	34781	32366R	32365R	—	—

● Nuevo número de parte

R Monro-Matic Plus Reforzado

■ Número de parte bajo pedido especial



## APLICACIONES

### DODGE — Pickup Ram 3500 Amortiguador de Dirección

		Sin Soporte	Con Soporte
2009-13	4WD	SC2968	—
2000-07	2WD y 4WD — Reemplaza # de E.O. 52106909AB, AC, AD y AE	SC2964	—
1994-97	3500 2WD y 4WD — Reemplaza # de E.O. 52038276	SC2953	—
1997-99	3500 2WD y 4WD — Reemplaza # de E.O. 52039280	SC2960	—

### DODGE — Pickup Ram 4500

2009-10	Chassis Cab	—	—	65164 <sup>[3]</sup> <sup>[17]</sup>	65181 <sup>[3]</sup> <sup>[17]</sup>	—	—	—	—
2008	Chassis Cab	—	—	65164 <sup>[3]</sup> <sup>[17]</sup>	65165 <sup>[3]</sup> <sup>[18]</sup>	—	—	—	—

### DODGE — Pickup Ram 4500 Amortiguador de Dirección

		Sin Soporte	Con Soporte
2008-10	Reemplaza # OEM 52855623AC,AD	SC2966	—

### DODGE — Pickup Ram 5500

2009-10	Chassis Cab	—	—	65164 <sup>[3]</sup> <sup>[17]</sup>	65181 <sup>[3]</sup> <sup>[17]</sup>	—	—	—	—
2008	Chassis	—	—	65164 <sup>[3]</sup> <sup>[17]</sup>	65165 <sup>[3]</sup> <sup>[18]</sup>	—	—	—	—

### DODGE — Pickup Ram 5500 Amortiguador de Dirección

		Sin Soporte	Con Soporte
2008-10	Reemplaza # OEM 52855623AC,AD	SC2966	—

### DODGE — Pickup D y W

1972-93	2WD (1/2 Ton) D-100, D-150 — Todos	—	37094	34750	34832	—	—	—	—
1961-71	2WD (1/2 Ton) D-100 — Todos	—	—	—	—	—	31131	—	—
1972-93	2WD (3/4 Ton) D-200, D-250 — Exc. Eje Delantero de 4,000 lb.	37096	37094	34750	34832	32127R	32385R	—	—
	2WD (3/4 Ton) D-200, D-250 — Todos c/ Eje Delantero de 4,000 lb.	—	—	34868	34832	—	—	—	—
1961-71	2WD (3/4 Ton) D-200 — Todos	—	—	—	—	—	31131	—	—
1972-93	2WD (1 Ton) D-300, D-350 — Todos Exc. Eje Delantero de 4,000 lb. y Diesel	—	—	34750	34832	32127R	32385R	—	—
	2WD (1 Ton) D-300, D-350 — Todos c/ Eje Delantero de 4,000 lb. y Diesel	—	—	34868	34832	32376R	32385R	—	—
	4WD (1/2 Ton) W-100, W-150 — Todos	37045■	37046■	34853	34854	—	—	—	—
1992-93	4WD (3/4 Ton) W-200, W-250 — Todos c/ 8,510 lb. PBV y Diesel	—	—	34853	34771	—	—	—	—
1972-93	4WD (3/4 Ton) W-200, W-250 — Todos Exc. c/ 8,510 lb. PBV y Diesel	—	—	34853	34854	—	—	—	—
1992-93	4WD (1 Ton) W-300, W-350 — Todos	—	—	34853	34771	—	—	—	—
1972-91	4WD (1 Ton) W-300, W-350 — Todos	—	—	34853	34854	—	—	—	—

### DODGE — Pickup D y W Amortiguador de Dirección

		Sin Soporte	Con Soporte
1972-93	D-100 y D-150 — Todos	—	SA1932

■ Número de parte bajo pedido especial

R Monro-Matic Plus Reforzado

[3] Puede que se requiera el juego de piezas AK30 para reemplazar los tornillos y las tuercas originales del montaje inferior si están dañados o si no es posible reutilizarlos.



## APLICACIONES

	<b>OESpectrum</b>	<b>GAS-MAGNUM®</b>	<b>MONRO-MATIC PLUS®</b>	<b>ROADMATIC</b>
	<b>Reflex</b>	<b>BASES DE AMORTIGUADOR</b> CUBREPOLVO	<b>MONRO-MATIC® HIDRÁULICO</b>	<b>LOAD ADJUSTING®</b> MAX-AIR®

### DODGE — Pickup D y W (Cont.) Amortiguador de Dirección

		Sin Soporte	Con Soporte
1989-93	D-200 y D-250 — Todos	SC2912	—
1972-88	D-200 y D-250 — Todos	SC2915	SA1932
1989-93	D-300 y D-350 — Todos	SC2912	—
1972-88	D-300 y D-350 — Todos	SC2915	SA1932
1972-93	W-100 y W-150 — Todos	SC2916	—
1959-71	W-100 1/2 Ton 4WD	SC2917 <sup>[33]</sup> <sup>[34]</sup> <sup>[3]</sup>	—
1972-79	W-200 3/4 Ton 4WD	SC2917 <sup>[33]</sup> <sup>[34]</sup> <sup>[3]</sup>	—

### DODGE — Ramcharger

1975-93	2WD — Todos	—	37094	34750	34832	32127R	32385R	—	—
1976-93	4WD — Todos	37045■	37046■	34853	34854	31131	—	—	—
1974-75	4WD — Todos	37045■	37094	34853	34832	31131	32385R	—	—

### DODGE — Ramcharger Amortiguador de Dirección

		Sin Soporte	Con Soporte
1974-93	AW-100 y AW-150	SC2916	—

### DODGE — Ram Cargo Caravan (C/V)

2012-15	Todos — Exc. Susp. Trasera Nivomat. Para Remolque	72780	37290	■906960	—	—	—	—	—
	Todos — c/ Susp. Trasera Nivomat.	72780	—	■906960	—	—	—	—	—
				⊕63631					58648
				⊕63631					

### DODGE — Sebring

2001-05	Coupe								
	Derecho	72147	71313	■904957	■902923	—	—	—	—
	Izquierdo	72148	71313	■904957	■902923	—	—	—	—
	Plato de Montura	—	—	—	■909947	—	—	—	—
	Aislador de Resorte Superior	—	—	—	909969■	—	—	—	—
				⊕63631	⊕63636				

### DODGE — Shadow

1989-94	Todos	72589 <sup>[2]</sup>	5962	■901908	—	—	33095	—	—
	Asiento y Aislador de Resorte Superior	—	—	■904916	—	—	—	—	—

### DODGE — Spirit

1989-95	Todos	72589 <sup>[2]</sup>	5962	■901908	—	—	33095	—	—
	Asiento y Aislador de Resorte Superior	—	—	■904916	—	—	—	—	—

### DODGE — Stratus

2001-05	Coupe								
	Derecho	72147	71313	■904957	■902923	—	—	—	—
	Izquierdo	72148	71313	■904957	■902923	—	—	—	—
	Plato de Montura	—	—	—	■909947	—	—	—	—
	Aislador de Resorte Superior	—	—	—	909969■	—	—	—	—
				⊕63631	⊕63636				

■ Número de parte bajo pedido especial

R Monro-Matic Plus Reforzado

[2] Puede que se requiera el juego de piezas AK37 para reemplazar los tornillos y las tuercas originales del montaje inferior si están dañados o si no es posible reutilizarlos.

[3] Se venden los cilindros como cilindros de repuesto para los juegos de estabilizador de dirección.

[34] Juego de fuelle SA-19XX está disponible para el uso con nuestros cilindros de estabilizador de dirección.



## APLICACIONES

		GAS-MAGNUM®		MONRO-MATIC PLUS®		ROADMATIC	
		BASES DE AMORTIGUADOR CUBREPOLVO		MONRO-MATIC® HIDRÁULICO		LOAD ADJUSTING® MAX-AIR®	

### DODGE — Stratus (Cont.)

1999-06	Todos — JR Sedán	71565 <sup>EL</sup>	71311 <sup>EL</sup>	901940®	901940® 63628	801565	801311	—	—
1995-98	Todos — JR Sedán	71897 <sup>EL</sup>	—	901940®	—	—	—	—	—

### DODGE — Van Ram

1970-03	(1/2 Ton) 1500, B-100, B-150 — Todos	911096■	—	34831	34910	—	33086R	—	—
	(3/4 Ton) 2500, B-200, B-250 — Todos	911096■	—	34831	34910	—	33086R	—	—
	(1 Ton) 3500, B-300, B-350 Todos — Exc. c/ 9,000 PBV y c/ Eje Delantero de 4,000 lb.	911096■	—	34831	34910	—	33086R	—	—
1994-03	(1 Ton) 3500, B-350 — Todos c/ 9,000 lb. PBV	—	—	34794	34910	—	33086R	—	—
1970-93	(1 Ton) B-300, B-350 — Todos c/ Eje Delantero de 4,000 lb.	—	—	34868	34910	—	—	—	—

### DODGE — Van Sprinter

2007-09	(3/4 Ton) 2500 — Todos	—	—	553003 902135●	66415 —	—	—	—	—
2003-06	(3/4 Ton) 2500 — Todos	—	—	553002	66415	—	—	—	—
2007-09	(1 Ton) 3500 — Todos Exc. Doble Rodado Trasero	—	—	553003 902135●	66415 —	—	—	—	—
	(1 Ton) 3500 — Todos c/ Doble Rodado Trasero	—	—	553003	66414	—	—	—	—
2003-06	(1 Ton) 3500 — Todos Exc. Doble Rodado Trasero	—	—	902135●	—	—	—	—	—
	(1 Ton) 3500 — Todos c/ Doble Rodado Trasero	—	—	553002	66417	—	—	—	—

### FIAT — 500L

2014-20	Sedán	—	5538	63631	—	—	—	—	—
---------	-------	---	------	-------	---	---	---	---	---

### FIAT — Strada

2007-16	Todos	71040	—	—	—	—	—	—	—
---------	-------	-------	---	---	---	---	---	---	---

### FIAT — Palio

2003-11	Todos — ABS	71040	5604	906902	—	—	—	—	—
	Derecho	71040	5604	906903	—	—	—	—	—
	Izquierdo	—	—	—	—	—	—	—	—
2003-06	Todos	—	5604	906902	—	—	—	—	—
	Derecho	—	5604	906903	—	—	—	—	—
	Izquierdo	—	—	—	—	—	—	—	—

### FORD — Aerostar (Mini) Van

1989-97	2WD — Todos	37058	37061	—	—	32132	—	250132	—
1986-88	2WD — Todos	37058	—	—	—	32132	—	250132	—
1990-97	4WD — Todos	—	37061	—	—	—	—	—	—

### FORD — Bronco

1980-96	Todos — Exc. c/ Susp. Quad	—	37037■	34729	34927	32227R 1406	1407	—	—
---------	----------------------------	---	--------	-------	-------	----------------	------	---	---

- Nuevo número de parte
- Número de parte bajo pedido especial
- R Monro-Matic Plus Reforzado

- ® Este número de pieza es una marca registrada de Tenneco y no se puede usar ni reproducir sin permiso.
- EL Unidad Premium que son considerados con vástago de extensión lenta.



## APLICACIONES

	<b>OESpectrum</b>	<b>GAS-MAGNUM®</b>	<b>MONRO-MATIC PLUS®</b>	<b>ROADMATIC</b>
	<b>Reflex</b>	<b>BASES DE AMORTIGUADOR</b> CUBREPOLVO	<b>MONRO-MATIC® HIDRÁULICO</b>	<b>LOAD ADJUSTING®</b> MAX-AIR®

### FORD — Bronco (Cont.)

1980-96 (Cont.)	Todos — c/ Susp. Quad	—	—	34729	—	32227R	—	—	—
	Después del Eje Frontal ( Cant. 2 )	—	—	—	—	1406	—	—	—
	Adelante del Eje Frontal ( Cant. 2 )	37036■	—	34926	—	32381R■	—	—	—
		—	37037■	—	34927	—	1407	—	—

### FORD — Bronco Amortiguador de Dirección

		Sin Soporte	Con Soporte
1980-96	Bronco y Bronco II Exc. C- Channel	SC2912	—
	Bronco y Bronco II c/ C- Channel	SC2912	SA1930

### FORD — C-Max

2013-18	Todos	—	5560●	908961	906981	—	—	—	—
				63631					

### FORD — Contour

Mar 1997-00	Todos	71687	71984	902953	—	—	—	—	—
1995-Feb 97	Todos — c/ Motor 4 Cilindros	—	71984	902953	—	—	—	—	—
	Todos — c/ Motor 6 Cilindros	—	—	902953	—	—	—	—	—

### FORD — Courier Pickup

2000-12	Todos	—	—	908963	—	801003	33146	—	—
---------	-------	---	---	--------	---	--------	-------	---	---

### FORD — Crown Victoria

2003-11	Todos — Patrulla	—	—	553001	550018	—	—	—	—
	Para Remolque	—	—	—	550055■	—	—	—	—
	Sedán — Exc. Patrulla	71346	5993	907944	—	—	—	—	—
1993-02	Todos — Exc. c/ Susp. Turing	5960	5961	—	—	33127	33128	—	—
	Todos — c/ Susp. Touring	5969	5967	—	—	—	33136	—	—
1983-91	Todos — Exc. Patrulla	5801	5961	—	—	32066	33128	—	—
1983-02	Todos — Patrulla	—	—	550010	550011	—	—	—	—

### FORD — EcoSport

2018-21	FWD	—	37392●	63632	—	—	—	—	—
2006-12	Todos — 2WD	—	37360	—	—	—	—	—	—
	Todos								
	Derecho	71056	37356	—	—	—	—	—	—
	Izquierdo	—	37356	—	—	—	—	—	—
2004-12	Todos — Exc. c/ Transmisión Automática	—	—	906904	—	801025	33157	400025	250157

### FORD — Edge

2019-22	Todos — Exc. ST	73059■	37389●	63631	—	—	—	—	—
	ST	73059■	37378	63631	—	—	—	—	—
2015-18	Todos — Exc. Sport	73059■	37389●	63631	—	—	—	—	—
	Sport	73059■	37378	63631	—	—	—	—	—
2011-14	Todos								
	Derecho	72888	37327	909906	—	—	33206●	—	—
	Izquierdo	72889	37327	909906	—	—	33206●	—	—
				63638■					

● Nuevo número de parte

R Monro-Matic Plus Reforzado

■ Número de parte bajo pedido especial





## APLICACIONES

		GAS-MAGNUM®		MONRO-MATIC PLUS®		ROADMATIC	
		BASES DE AMORTIGUADOR CUBREPOLVO		MONRO-MATIC® HIDRÁULICO		LOAD ADJUSTING® MAX-AIR®	

### FORD — Edge (Cont.)

2007-10	Todos								
	Derecho	72888	37302	—	—	—	33202●	—	—
	Izquierdo	72889	37302	—	—	—	33202●	—	—
				63638■					

### FORD — Escape

Abr 15	Todos								
2014-19	Derecho	72750	39111	908961	906981	—	—	—	—
	Izquierdo	72751	39111	908961	906981	—	—	—	—
				63631					
Ene 1- Abr 14	Todos								
2014	Derecho	72748	39111	908961	—	—	—	—	—
	Izquierdo	72749	39111	908961	906981	—	—	—	—
				63631					
2013	Todos								
	Derecho	72618	39111	908961	—	—	—	—	—
	Izquierdo	72619	39111	908961	906981	—	—	—	—
				63631					
2008-12	Todos								
	Derecho	71593	37318	904938	—	—	33200●	—	—
	Izquierdo	71594	37318	904938	—	—	33200●	—	—
				63631					
2001-07	Todos								
	Derecho	71593	37217	904938	—	—	33187	—	—
	Izquierdo	71594	37217	904938	—	—	33187	—	—
				63631					

### FORD — Escort

1998-03	ZX2 Todos — Exc. c/ Frenos ABS	—	—	904913	—	—	—	—	—
				63619	63619				
1997-03	Todos — Exc. ZX2 Coupé y c/ Frenos ABS	—	—	904913	—	—	—	—	—
				63619	63619				
1991-96	GT Motor 1.8 lts. 16 Válvulas	—	—	—	—	—	—	—	—
				63619	63618				
1986-90	GT	—	—	—	—	—	—	—	—
				63619	63620				
Mar 1985-90	Todos Inc. EXP — Exc. GT	—	—	—	—	—	—	—	—
				63619	63620				
Feb 1983- Feb 85	Todos Inc. EXP	—	—	—	—	—	—	—	—
				63619	63620				

### FORD — Excursion

2000-05	2WD — Todos	911173	911174	34684	34517	32356	—	—	—
	4WD — Todos	911175■	911176■	34518■	34519■	—	—	—	—

### FORD — Expedition

2022	Todos — Exc. Susp. Elect. y c/ Susp. De Nivelación de Carga Trasera	—	—	906963	907934	—	—	—	—
------	---	---	---	--------	--------	---	---	---	---

● Nuevo número de parte

■ Número de parte bajo pedido especial

## APLICACIONES

	DESpectrum <i>Reflex</i>		GAS-MAGNUM® BASES DE AMORTIGUADOR CUBREPOLVO		MONRO-MATIC PLUS® MONRO-MATIC® HIDRÁULICO		ROADMATIC LOAD ADJUSTING® MAX-AIR®	

### FORD — Expedition (Cont.)

2018-21	Todos — Exc. Susp. Elect. y c/ Susp. De Nivelación de Carga Trasera	—	71139	906963	907934	—	—	—	—
2014-17	Todos — Exc. Susp. Elect. y c/ Susp. de Aire	72900	71139	906963	907934	—	—	—	—
2007-13	2WD y 4WD — Exc. c/ Susp. de Aire	71138	71139	906963	907934	—	—	—	—
2003-06	2WD — Todos Exc c/ Susp. Automática Nivelable Kit de Conversión	— 90015C <sup>[200]</sup>	— 90015C <sup>[200]</sup>	904974 —	904973 —	— —	— —	— —	— —
1997-02	2WD — Todos Exc. c/ Nivelación de Aire Trasero	37131	—	34655	—	32302R	32322R	250302	250322
	2WD — Todos c/ Susp. Nivelable de Aire Trasera Kit de Conversión	37131	37154	34655	—	32302R	32322R	250302	250322
	Kit de Conversión	90005C1 ■	90005C1 ■	—	—	—	—	—	—
	Kit de Conversión	90005C2 ■	90005C2 ■	—	—	—	—	—	—
2003-06	4WD — Todos Exc. c/ Sist. de Nivelación de Aire	—	—	904974	904973	—	—	—	—
1997-02	4WD — Todos Exc. c/ Sist. de Nivelación de Aire en las 4 Esquinas	—	—	34657	34672	32304R	32323R	—	—
	4WD — Todos c/ Sist. de Nivelación de Aire en las 4 Esquinas	—	37202	—	—	—	—	—	—

### FORD — Explorer

Sep 2012-19	Patrulla Derecho	—	—	553024	—	—	—	—	—
	Izquierdo	—	—	909916	—	—	—	—	—
		—	—	553025	—	—	—	—	—
		—	—	909916	—	—	—	—	—
	Todos — Exc. Patrulla	—	—	63631	—	—	—	—	—
	Derecho	72729	911330	909916	—	—	—	—	—
	Izquierdo	72730	911330	909916	—	—	—	—	—
		—	—	63631	—	—	—	—	—
2011-Sep 12	Todos Derecho	72620	911330	909905	—	—	—	—	—
	Todos Izquierdo	72621	911330	909905	—	—	—	—	—
		—	—	63633	—	—	—	—	—
2006-10	Todos	71124	71125	907937	907940	—	—	—	—
2004-05	Todos	—	71322	—	—	—	—	—	—
	Plato de Montura Superior	—	—	906918	906927	—	—	—	—
2002-03	2WD — Todos	71321	71322	—	—	—	—	—	—
	Plato de Montura Superior	—	—	906918	906927	—	—	—	—
1995-01	2WD — Todos	37177	—	—	—	32346	32253	250008 ●	250004 ●
1991-94	2WD — Todos	37015	—	—	—	32235	32253	250005 ●	250004 ●
2002-03	4WD — Todos	71321	71322	—	—	—	—	—	—
	Plato de Montura Superior	—	—	906918	906927	—	—	—	—

● Nuevo número de parte

■ Número de parte bajo pedido especial

R Monro-Matic Plus Reforzado

[200] Requiere de 1 Kit por vehículo.



## APLICACIONES

		GAS-MAGNUM®		MONRO-MATIC PLUS®		ROADMATIC	
		BASES DE AMORTIGUADOR		MONRO-MATIC® HIDRÁULICO		LOAD ADJUSTING®	
		CUBREPOLVO				MAX-AIR®	

### FORD — Explorer (Cont.)

1995-01	4WD — Todos Exc. c/ Control de Manejo Automático	37122	—	34804	—	32296	32253	250006●	250004●
1991-94	4WD — Todos	37015	—	—	—	32235	32253	250005●	250004●
2007-10	Sport Trac 2WD y 4WD — Todos	71124	71125	907937	907940	—	—	—	—
2001-06	Sport Trac 2WD — Todos	37177	—	—	—	32346	32253	250008●	250004●
	Sport Trac 4WD — Todos	37122	—	34804	—	32296	32253	250006●	250004●

### FORD — Explorer Amortiguador de Dirección

		Sin Soporte	Con Soporte
1995-00	2WD y 4WD - Amortiguador de Eje Trasero	SC2958	—

### FORD — Fairline y Fairline 500

1966-70	Sedán, Coupé, Convertible, Fastback y Hardtop	5809	—	—	—	—	31069	—	—
	Station Wagon	5809	5818	—	—	—	—	—	—
1962-65	Todos	—	—	—	—	—	31069	—	—
1957-61	Todos — Exc. Sunlener	5801	—	—	—	32066	—	—	—
1978-83	Fairmont Elite I y II — Todos	71828 <sup>[8]</sup>	5847	901925	—	—	—	—	—

### FORD — Falcon

1966-70	Falcon — Sedán, Coupé y Hardtop	5809	—	—	—	—	—	—	—
	Falcon — Station Wagon	5809	5818	—	—	—	—	—	—

### FORD — Fiesta

2014 - 19	Todos — Exc. Paquete ST Derecho Izquierdo	72778	5630	—	907997	—	—	—	—
		72779	5630	—	907997 63636	—	—	—	—
2014-15	Modelo ST Derecho Izquierdo	72785	5511	—	—	—	—	—	—
		72786	5511	—	—	—	—	—	—
2011-13	Todos Derecho Izquierdo	72524	5630	907996	907997	—	—	—	—
		72525	5630	907996 63631	907997 63636	—	—	—	—
2003-10	Todos	—	—	906904	906906	801028	33158	400028	250158
1998-05	Todos — 1.0/1.3 Dirección Mecánica	—	—	908963	908964	801018	—	—	—
		—	—	904961 <sup>[8]</sup>	—	—	—	—	—
	Todos — 1.0/1.3 Dirección Hidráulica	—	—	908963	908964	801019	—	—	—

### FORD — Fiesta Ikon

2011-15	Todos Derecho Izquierdo	73017	5533	—	—	—	—	—	—
		73018	5533	—	—	—	—	—	—

### FORD — Five Hundred

2005-07	FWD Aislador de Resorte Superior	—	72539	905915	—	—	—	—	—
		—	—	—	—	—	—	—	—

● Nuevo número de parte

[8] Este número de parte incluye: Base de amortiguador, cubre polvo y tope de rebote

[1] Puede que se requiera el juego de piezas AK27 para reemplazar los tornillos y las tuercas originales del montaje inferior si están dañados o si no es posible reutilizarlos.

[8] El compresor de resorte NO ES necesario para reemplazar los struts en este vehículo.



## APLICACIONES

		<b>GAS-MAGNUM®</b> BASES DE AMORTIGUADOR CUBREPOLVO		<b>MONRO-MATIC PLUS®</b> MONRO-MATIC® HIDRÁULICO		<b>ROADMATIC</b> LOAD ADJUSTING MAX-AIR®	

### FORD — Five Hundred (Cont.)

2005-07 (Cont.)	AWD — Exc. Susp. trasera autonivelable Nivomat								
	Derecho	72613	72538■	905915	—	—	—	—	—
	Izquierdo	72612	72538■	905915	—	—	—	—	—

### FORD — Flex

2013-19	Todos	—	37329	909916	—	—	—	—	—
	Aislador de Resorte Inferior	—	—	907999 63631	—	—	—	—	—
2012	Todos								
	Derecho	72535	37329	909915	—	—	—	—	—
	Izquierdo	72534	37329	909915	—	—	—	—	—
	Aislador de Resorte Inferior	—	—	907999	—	—	—	—	—
2011	Todos								
	Derecho	72535	37329	—	—	—	—	—	—
	Izquierdo	72534	37329	—	—	—	—	—	—
	Aislador de Resorte Inferior	—	—	907999	—	—	—	—	—
2010	Todos								
	Derecho	72535	37329	909914	—	—	—	—	—
	Izquierdo	72534	37329	909914	—	—	—	—	—
	Aislador de Resorte Inferior	—	—	907999	—	—	—	—	—
Jul 2009- Dic 09	Todos								
	Derecho	72535	37329	—	—	—	—	—	—
	Izquierdo	72534	37329	—	—	—	—	—	—
	Montura sin aislador superior	—	—	906962	—	—	—	—	—
	Montura con aislador superior	—	—	909914	—	—	—	—	—
	Aislador de Resorte Inferior	—	—	907999	—	—	—	—	—
May 2008-Jul 09	Todos								
	Derecho	—	37329	—	—	—	—	—	—
	Izquierdo	—	37329	—	—	—	—	—	—
	Montura sin aislador superior	—	—	906962	—	—	—	—	—
	Montura con aislador superior	—	—	909914	—	—	—	—	—
	Aislador de Resorte Inferior	—	—	907999	—	—	—	—	—

### FORD — Focus

2017-18	Todos — Exc. RS								
	Derecho	72907	5645	—	906981	—	—	—	250010●
	Izquierdo	72908	5645	—	906981	—	—	—	250010●
	RS	—	5678	908961 63632	906981	—	—	—	—
2014-16	ST								
	Derecho	72923	5678	908961	906981	—	—	—	—
	Izquierdo	72924	5678	908961	906981	—	—	—	—
Feb 2013-16	Todos — Exc. ST								
	Derecho	72907	5645	908961	906981	—	—	—	250010●
	Izquierdo	72908	5645	908961 63632	906981	—	—	—	250010●
2013	ST								
	Derecho	72743	5678	—	—	—	—	—	—
	Izquierdo	—	5678	—	—	—	—	—	—

● Nuevo número de parte

■ Número de parte bajo pedido especial



## APLICACIONES



### FORD — Focus (Cont.)

2012-Feb 13	Todos — Exc. ST	72522	5645			—	—	400012●	250010●
	Derecho	72523	5645			—	—	400013●	250010●
2008-11	Todos — Exc. Modelo Europa	72257	5796	—	—	—	32404	—	250000
	Derecho	72258	5796	—	—	—	32404	—	250000
2006-07	Sedán — Exc. Modelo Europa	72257	5796		—	—	32404	—	250000
	Derecho	72258	5796		—	—	32404	—	250000
2002-05	Hatchback Coupé ZX3 y Sedán LX, SE, ZTS — Exc. SVT	71504	5796		—	801504	32404	401044	250000
	Derecho	71505	5796		—	801505	32404	401045	250000
2000-01	Hatchback Coupé ZX3 y Sedán LX, SE, ZTS — Exc. SVT	71504	5796		—	801504	32404	401044	—
	Derecho	71505	5796		—	801505	32404	401045	—
2000-05	Station Wagon SE, ZTS	71504	5986		—	801504	—	401044	—
	Derecho	71505	5986		—	801505	—	401045	—

### FORD — Freestar (Mini Van)

2004-07	Todos	—	37110	—	—	—	—	—	—
---------	-------	---	-------	---	---	---	---	---	---

### FORD — Freestyle

2005-07	AWD	—	—		—	—	—	—	—
	Derecho	72610	—		—	—	—	—	—
2005-07	FWD	—	72595■		—	—	—	—	—
	Derecho	72610	72595■		—	—	—	—	—

### FORD — Fusion

2013-20	Todos — Exc. Sport y 2.7L	72638	5667■		—	—	—	—	—
2010-12	Todos	72596	5784		—	—	—	—	—
	Aislador de Resorte Inferior	—	—		—	—	—	—	—
2006-09	Todos	72261 <sup>el</sup>	5784		—	—	—	—	—

### FORD — Galaxie

1965-74	Todos	5801	5803	—	—	32066	33049	—	—
---------	-------	------	------	---	---	-------	-------	---	---

### FORD — Ghia

1986-94	Todos	—	—			—	—	—	—
---------	-------	---	---	--	--	---	---	---	---

● Nuevo número de parte

■ Número de parte bajo pedido especial

<sup>el</sup> Unidad Premium que son considerados con vástago de extensión lenta.



## APLICACIONES

	<b>OESpectrum</b>	<b>GAS-MAGNUM®</b>	<b>MONRO-MATIC PLUS®</b>	<b>ROADMATIC</b>
	<b>Reflex</b>	<b>BASES DE AMORTIGUADOR</b> <b>CUBREPOLVO</b>	<b>MONRO-MATIC® HIDRÁULICO</b>	<b>LOAD ADJUSTING®</b> <b>MAX-AIR®</b>

### FORD — Ghia (Cont.)

1984-85	Todos	—	—	—	—	—	—	—	—
				63620	63620				

### FORD — Grand Marquis

2003-11	Todos	71346	5993	907944	—	—	—	—	—
2001-02	Todos	5960	5961	—	—	33127	33128	—	—

### FORD — Ikon

1998-08	Todos	—	—	908963	908964	801001	801002	—	—
				904961	—	—	—	—	—

### FORD — KA

2001-08	Todos	—	—	908963	908964	801006	801012	—	—
				904961	—	—	—	—	—

### FORD — LTD

1967-82	Todos	5801	5803	—	—	32066	33049	—	—
---------	-------	------	------	---	---	-------	-------	---	---

### FORD — LTD II

1977-79	Todos	5801	5818	—	—	32066	—	—	—
---------	-------	------	------	---	---	-------	---	---	---

### FORD — Maverick

1969-77	Todos	—	—	—	—	33059	—	—	—
---------	-------	---	---	---	---	-------	---	---	---

### FORD — Mystique

Mar	Todos	71687	71984	902953	—	—	—	—	—
1997-00									

### FORD — Mondeo

2001-07	Todos	—	—	902123	—	—	—	—	—
---------	-------	---	---	--------	---	---	---	---	---

### FORD — Mustang

2015-22	Convertible — EcoBoost, EcoBoost Premium, GT, GT Premium, GT Edición 50 Años — Exc. Modelos c/ Rin de fabrica de 20"	73012	—	—	—	—	—	—	—
	Coupe — EcoBoost, EcoBoost Premium, GT, GT Premium, GT Edición 50 Años, Convertible, Coupe c/ Paquete Performance — Exc. Modelos c/ Rin de fabrica de 20"	73012	—	—	—	—	—	—	—
	Coupe — EcoBoost, EcoBoost Premium, GT, GT Premium, GT Edición 50 Años — Exc. Modelos c/ Rin de fabrica de 20" y Paquete Performance	73012	5512	—	—	—	—	—	—
2015-17	Todos — c/ Motor de 3.7 Litros	72929	5512	—	—	—	—	—	—
2011-14	Todos — Exc. Boss 302 y Shelby GT500 c/ Susp. de Alto Desempeño	72540	5783	909906	—	—	—	—	—
2005-10	Todos	72138	5783	905915	—	—	—	—	—
1999-04	Cobra — Todos	71963	—	901925	—	—	—	—	—
				63621					

● Nuevo número de parte

Ⓩ Se requiere el juego de piezas AK38 para instalar esta unidad.

Ⓛ Este número de parte incluye: Base de amortiguador, cubre polvo y tope de rebote



## APLICACIONES

		 BASES DE AMORTIGUADOR CUBREPOLVO	 MONRO-MATIC® HIDRÁULICO	 LOAD ADJUSTING MAX-AIR®

### FORD — Mustang (Cont.)

1994-04	Todos — Exc. GT y Cobra	71962	5968	901925 63621	—	801962	33137	—	—
	GT — Todos	71963	5968	901925 63621	—	—	33137	—	—
1994-98	Cobra — Todos	71963	5968	901925 63621	—	—	33137	—	—
1985-93	Todos — Exc. GT, LX y SVO	71828 <sup>[1]</sup>	5847	901925 63621	—	—	—	—	—
1974-78	II — Todos	—	—	—	—	32118	32191	—	—
1965-70	Todos	—	—	—	—	33059	31069	—	—

### FORD — Pickup Serie F-100, F-150, Lobo

2021	2WD (1/2 Ton) F-150, Lobo — Todos	—	911334	—	—	—	—	—	—
2015-20	2WD (1/2 Ton) F-150, Lobo — Todos	73031	911334	906963 63631	—	—	—	—	—
2014	c Para Remolque Para Remolque	72651 — —	911331	906963 63631	— — —	— — —	— — —	— — —	58643 MA835
2009-13	2WD (1/2 Ton) F-150, Lobo — Todos Para Remolque Para Remolque	71140 — —	911331	906963 63631	— — —	— — —	— — —	— — —	58643 MA835
2004-08	2WD (1/2 Ton) F-150, Lobo — Todos Inc. Super Crew — Exc. Lighthing Para Remolque	71362 —	911261	904970 63631	— —	— —	— —	— —	58642■
2004	2WD (1/2 Ton) F-150, Lobo — Serie Heritage — Exc. 7,700 lb. PBV Para Remolque	37131 911131 —	911132	34655 34673 —	34656 34673 —	32302R 32324R —	32303R 32324R —	250302 250302 —	250303 — MA829
2000-04	2WD (1/2 Ton) F-150, Lobo — Todos c/ 7,700 lb. PBV	911131	37147	34655	34673	32302R	32324R	250302	—
1997-03	2WD (1/2 Ton) F-150, Lobo Todos Inc. Super Crew — Exc. c/ 7,700 lb. PBV Para Remolque	911131 —	911132	34655 —	34656 —	32302R —	32303R —	250302 —	250303 MA829
1985-96	2WD (1/2 Ton) F-150, Lobo — Todos Para Remolque	— —	37052	34729 —	34963 —	1406 —	1407 —	— —	— MA726■
1980-84	2WD (1/2 Ton) F-100, F-150, Lobo — Todos Para Remolque	— —	37037■	34729 —	34927 —	32227R 1406 —	— —	— —	— MA773■
1970-79	2WD (1/2 Ton) F-100, F-150	—	—	34900	34911	32075R 1420	32080R 1412	—	—
2015-20	4WD (1/2 Ton) Serie F-150 — Exc. Raptor	73032	911335	906963 63631	—	—	—	—	—

■ Número de parte bajo pedido especial

R Monro-Matic Plus Reforzado

[1] Puede que se requiera el juego de piezas AK27 para reemplazar los tornillos y las tuercas originales del montaje inferior si están dañados o si no es posible reutilizarlos.

[8] El compresor de resorte NO ES necesario para reemplazar los struts en este vehículo.

## APLICACIONES

	<b>OESpectrum</b> <i>Reflex</i>	<b>GAS-MAGNUM®</b> BASES DE AMORTIGUADOR CUBREPOLVO	<b>MONRO-MATIC PLUS®</b> MONRO-MATIC® HIDRÁULICO	<b>ROADMATIC</b> LOAD ADJUSTING® MAX-AIR®

### FORD — Pickup Serie F-100, F-150, Lobo (Cont.)

2014	4WD (1/2 Ton) Serie F-150 — Exc. SVT Raptor Para Remolque Para Remolque	72652	911332	906963	—	—	—	—	—
		—	—	—	—	—	—	—	58653 MA836
		—	—	63631	—	—	—	—	—
2009-13	4WD (1/2 Ton) Serie F-150 — Exc. SVT Raptor Para Remolque Para Remolque	71141	911302	906963	550062	—	—	—	—
		—	—	—	—	—	—	—	58653 MA836
		—	—	63631	—	—	—	—	—
2004-08	4WD (1/2 Ton) F-150, Lobo Todos — Inc. Super Crew Para Remolque	71361	911262	904970	550063	—	—	—	—
		—	—	—	—	—	—	—	58643
1997-03	4WD (1/2 Ton) F-150, Lobo Todos — Exc. c/ Paq. 7,700 lb. PBV	—	911134	34657	34658	32304R	—	—	—
1990-96	4WD (1/2 Ton) F-150, Lobo Todos — Exc. Quad Cab	—	911039	34729	34964	32227R 1406	32386R	—	—
1986-89	4WD (1/2 Ton) F-150, Lobo Todos — Exc. Quad Cab	—	—	34729	34930	32227R 1406	32239R	—	—
1980-85	4WD (1/2 Ton) F-150, Lobo Todos — Exc. Super Cab y c/ Susp. Quad	—	—	34729	34930	32227R 1406	32239R	—	—
	4WD (1/2 Ton) F-150, Lobo — Todos Super Cab	—	—	34928	34930	—	—	—	—

### FORD — Pickup Serie F-100, F-150, Lobo Amortiguador de Dirección

		Sin Soporte	Con Soporte
1980-93	F-100 y F-150 2WD	SC2912	SA1930
1959-65	F-100 - 1/2 Ton 4WD	SC2917 <sup>[33]</sup> <sup>[34]</sup> <sup>[33]</sup>	—
		<sup>[34]</sup>	—
1980-96	F-150 c/ Doble Tracción en Eje Delantero	SC2912	SA1930

### FORD — Pickup Serie F-250

2017-22	2WD (3/4 Ton) F-250 — Todos Superduty	911173	—	34684	550065	32356	—	—	—
2005-16	2WD (3/4 Ton) F-250 — Todos Superduty	911173	911265	34684	34770	32356	—	—	—
1999-04	2WD (3/4 Ton) F-250 — Todos Superduty	911173	911194	34684	34685	32356	32357R	—	—
1997-99	2WD (3/4 Ton) F-250 Todos — Exc. c/ Sist. Nivelable de Aire Trasero	911131	37147	34655	34673	32302R	32324R	250302	—
	2WD (3/4 Ton) F-250 Todos — c/ Sist. Nivelable de Aire Trasero	911131	—	34655	—	—	—	—	—
1992-96	2WD (3/4 Ton) F-250 Todos — Exc. c/ 8,600 lb. PBV	—	37052	34793	34963	32280R	32231R	—	—
	2WD (3/4 Ton) F-250 — Todos c/ 8,600 lb. PBV	—	—	34793	34797	32280R	32372R	—	—
1987-91	2WD (3/4 Ton) F-200, F-250 — Todos	—	37052	34730	34963	—	32231R 1407	—	—
1980-86	2WD (3/4 Ton) F-250 — Todos	—	37052	34729	34963	32227R 1406	32231R 1407	—	—

**R** Mono-Matic Plus Reforzado

<sup>[33]</sup> Se venden los cilindros como cilindros de repuesto para los juegos de estabilizador de dirección.

<sup>[34]</sup> Juego de fuelle SA-19XX está disponible para el uso con nuestros cilindros de estabilizador de dirección.





## APLICACIONES

	<b>OESpectrum</b>	<b>GAS-MAGNUM®</b>	<b>MONRO-MATIC PLUS®</b>		<b>ROADMATIC</b>	
	<b>Reflex</b>	BASES DE AMORTIGUADOR CUBREPOLVO	MONRO-MATIC® HIDRÁULICO		LOAD ADJUSTING® MAX-AIR®	

### FORD — Pickup Serie F-250 (Cont.)

2020-22	4WD (3/4 Ton) F-250 — Exc. Suspensión Performance	911266	—	34525	550066	—	—	—	—
2017-19	4WD (3/4 Ton) F-250 — Todos Superduty	911266	—	34525	550066	—	—	—	—
2005-16	4WD (3/4 Ton) F-250 — Todos Superduty	911266	911267	34525	34526	—	—	—	—
1999-04	4WD (3/4 Ton) F-250 — Todos Superduty	—	911196	34686	34687	32358R	32359R	—	—
1997-99	4WD (3/4 Ton) F-250 Todos — Exc. c/ Sist. de Nivelación de Aire Trasero	—	37148■	34657	34674	32304R	32325R	—	—
1992-96	4WD (3/4 Ton) F-250 — Todos	911055	911039	34732	34964	—	—	—	—
1987-91	4WD (3/4 Ton) F-250 — Todos	911055	—	34732	34930	—	—	—	—
1980-86	4WD (3/4 Ton) F-250 — Todos	—	—	34928	34930	—	—	—	—

### FORD — Pickup Serie F-250 Amortiguador de Dirección

		Sin Soporte	Con Soporte
2008-16	4WD	SC2967	—
1999-04	4WD — Reemplaza # de E.O. F81A-3E651-DA	SC2961	—
1992-07	2WD - s/ Amortiguador de Dirección de E.O. (2005-07 Reemplaza # de E.O. 5C3Z-3E651-BA)	SC2955	—
1980-96	2WD s/ Amortiguador de Dirección de E.O.	SC2912	SA1930
	4WD c/ C-Channel	SC2912	SA1930
1974-77	3/4 Ton 4WD - Construido antes de Mar. 1, 1977	SC2917 <sup>[33]</sup> <sup>[34]</sup> <sup>[33]</sup>	—
1966-73	3/4 Ton 4WD - Exc. c/ Direccion Electrónica	SC2917 <sup>[33]</sup> <sup>[34]</sup> <sup>[33]</sup>	—
		<sup>[34]</sup>	—
1959-65	3/4 Ton 4WD - Todos	SC2917 <sup>[33]</sup> <sup>[34]</sup> <sup>[33]</sup>	—
		<sup>[34]</sup>	—

### FORD — Pickup Serie F-350

2017-22	2WD (1 Ton) F-350 — Todos Superduty Chassis Cab, Rodado sencillo y doble rodado.	911173	—	34684	550065	32356	—	—	—
2008-16	2WD (1 Ton) F-350 — Todos Superduty Chassis Cab	911173	37052	34684	34963	32356	32231R	—	—
2005-16	2WD (1 Ton) F-350 — Todos Superduty	911173	911265	34684	34770	32356	—	—	—
1999-09	2WD (1 Ton) F-350 — Todos Superduty Chassis Cab	911173	37052	34684	34963	32356	32231R 1407	—	—
1999-04	2WD (1 Ton) F-350 — Todos Superduty Inc. Crew Cab	911173	911194	34684	34685	32356	32357R	—	—
1992-98	2WD (1 Ton) F-350 — Todos Chassis Cab	—	—	34793	34731	32280R	—	—	—
	2WD (1 Ton) F-350 — Todos	—	—	34793	34797	32280R	32372R	—	—
1987-91	2WD (1 Ton) F-350 — Todos Chassis Cab	—	—	34730	34731	—	—	—	—
	2WD (1 Ton) F-350 — Todos	—	—	34730	34963	—	32231R	—	—
1984-86	2WD (1 Ton) F-350 — Todos Chassis Cab	—	—	34729	34731	32227R	—	—	—

■ Número de parte bajo pedido especial

R Monro-Matic Plus Reforzado

[33] Se venden los cilindros como cilindros de repuesto para los juegos de estabilizador de dirección.

[34] Juego de fuelle SA-19XX está disponible para el uso con nuestros cilindros de estabilizador de dirección.

## APLICACIONES

	<b>OESpectrum</b> <i>Reflex</i>	<b>GAS-MAGNUM®</b> BASES DE AMORTIGUADOR CUBREPOLVO	<b>MONRO-MATIC PLUS®</b> MONRO-MATIC® HIDRÁULICO	<b>ROADMATIC</b> LOAD ADJUSTING® MAX-AIR®

### FORD — Pickup Serie F-350 (Cont.)

1984-86 (Cont.)	2WD (1 Ton) F-350 Todos — Exc. Modelos c/ Doble Rodado Trasero	—	37052	34729	34963	32227R 1406	32231R 1407	—	—
	2WD (1 Ton) F-350 — Todos Modelos c/ Doble Rodado Trasero	—	—	34729	34731	32227R 1406	—	—	—
1980-83	2WD (1 Ton) F-350 — Todos Chassis Cab	—	—	34729	34963	32227R	32231R	—	—
	2WD (1 Ton) F-350 — Todos Crew Cab	—	—	34729	34731	32227R 1406	—	—	—
	2WD (1 Ton) F-350 Todos — Exc. Crew Cab	—	37052	34729	34963	32227R 1406	32231R 1407	—	—
1974-79	2WD (1 Ton) F-350 Serie Superduty — Todos Super Cab	—	—	34900	34911	32075R	32080R	—	—
1967-79	2WD (1 Ton) F-350 Serie Superduty Todos Exc. Super Cab	—	—	34900	34958	32075R	—	—	—
2020-21	4WD (1 Ton) F-350 Todos Superduty — Exc. Susp. Performance	911266	—	34525	550066	—	—	—	—
2017-19	4WD (1 Ton) F-350 Todos Superduty — Chassis Cab, Rodado Sencillo, Doble Rodado	911266	—	34525	550066	—	—	—	—
2008-16	4WD (1 Ton) F-350 Todos Superduty — Exc. c/ Chassis Cab	911266	911268■	34525	34687	—	32359R	—	—
	4WD (1 Ton) F-350 — Todos Superduty c/ Chassis Cab	911266	911039	34525	34964	—	32386	—	—
2005-07	4WD (1 Ton) F-350 — Todos Superduty c/ Doble Rodado Trasero	911266	911267	34525	34526	—	—	—	—
	4WD (1 Ton) F-350 Todos Superduty — Exc. c/ Doble Rodado Trasero	911266	911268■	34525	34687	—	32359R	—	—
1999-04	4WD (1 Ton) F-350 — Todos Superduty Chassis Cab	—	911039	34686	34964	32358R	32386	—	—
	4WD (1 Ton) F-350 — Todos Superduty	—	911196	34686	34687	32358R	32359R	—	—
1985-98	4WD (1 Ton) F-350 Todos Superduty — Exc. c/ Doble Rodado Trasero	911055	911039	34732	34964	—	—	—	—
	4WD (1 Ton) F-350 — Todos Superduty c/ Doble Rodado Trasero	911055	—	34732	34930	—	32239R	—	—
1980-85	4WD (1 Ton) F-350 — Todos Superduty	—	—	34928	34930	—	32239R	—	—

### FORD — Pickup Serie F-350 Amortiguador de Dirección

		Sin Soporte	Con Soporte
1980-97	2WD c/ C-Channel s/ Amortiguador de Dirección de E.O	SC2912	SA1930
1980-96	4WD c/ C-Channel	SC2912	SA1930
2008-16	4WD	SC2967	—

■ Número de parte bajo pedido especial

R Monro-Matic Plus Reforzado



## APLICACIONES

### FORD — Pickup Serie F-350 (Cont.) Amortiguador de Dirección

		Sin Soporte	Con Soporte
1999-04	4WD — Reemplaza # de E.O. F81A-3E651-DA	SC2961	—
1992-07	2WD — Reemplaza # de E.O. 5C3Z-3E651-BA, F7UZ-3E651-AA, -AB; F2UA-3E651-AB y F7UZ-3E651-AA	SC2955	—

### FORD — Pickup Serie F-450

2007-16	2WD F-450 — Todos Exc. Chassis Cab	—	—	65167	65174	—	—	—	—
2007-12	2WD F-450 — Todos Chassis Cab	—	—	65167	65168	—	—	—	—
2005-06	2WD F-450 — Todos Superduty (F47)	—	—	34523	34524	—	—	—	—
1999-04	2WD F-450 — Todos Superduty	—	—	34686	34930	32358R	32239R	—	—
1993-98	2WD F-450 — Todos Superduty	—	—	34791	34927	32370R	—	—	—
1988-93	2WD F-450 — Todos Superduty	—	—	34733■	34927	—	—	—	—
2017-19	4WD F-450 Todos Superduty	34523	—	65167	—	—	—	—	—
2007-16	4WD F-450 Todos Superduty — Exc. Chassis Cab (F47)	—	—	65167	65174	—	—	—	—
	4WD F-450 Todos Superduty — Chassis Cab (F47) c/ Attitude ride Height	—	—	65167	—	—	—	—	—
2007-15	4WD F-450 Todos Superduty Chassis Cab (F47)	—	—	65167	65168	—	—	—	—
	4WD F-450 — Todos Superduty Chassis Cab (F47) c/ Attitude ride Height	—	—	34523	34524	—	—	—	—
2005-06	4WD F-450 — Todos Superduty (F47)	—	—	34523	34524	—	—	—	—
1999-04	4WD F-450 — Todos Superduty	—	—	34686	34930	32358R	32239R	—	—

### FORD — Pickup Serie F-450 Amortiguador de Dirección

		Sin Soporte	Con Soporte
2005-07	2WD — Reemplaza # de E.O. 5C3Z3E651CA	SC2965	—
1999-04	2WD s/ Amortiguador de Dirección de E.O.	SC2961	—
	4WD — Reemplaza # de E.O. F81A-3E651-DA	SC2961	—

### FORD — Pickup Serie F-550

2007-12	2WD F-550 — Todos Chassis Cab	—	—	65167	65168	—	—	—	—
2005-06	2WD F-550 — Todos Superduty	—	—	34523	34524	—	—	—	—
1999-04	2WD F-550 — Todos Superduty	—	—	34686	34930	32358R	32239R	—	—
2007-16	4WD F-550 Todos Superduty — Chassis Cab	—	—	65167	65168	—	—	—	—
2005-06	4WD F-550 — Todos Superduty	—	—	34523	34524	—	—	—	—
1999-04	4WD F-550 — Todos Superduty	—	—	34686	34930	32358R	32239R	—	—

### FORD — Pickup Serie F-550 Amortiguador de Dirección

		Sin Soporte	Con Soporte
2005-07	2WD — Reemplaza # de E.O. 5C3Z3E651CA	SC2965	—
1999-04	2WD s/ Amortiguador de Dirección de E.O.	SC2961	—
	4WD — Reemplaza # de E.O. F81A-3E651-DA	SC2961	—

■ Número de parte bajo pedido especial

R Monro-Matic Plus Reforzado



## APLICACIONES

	<b>OESpectrum</b>	<b>GAS-MAGNUM®</b>		<b>MONRO-MATIC PLUS®</b>		<b>ROADMATIC</b>	
	<b>Reflex</b>	BASES DE AMORTIGUADOR CUBREPOLVO		MONRO-MATIC® HIDRÁULICO		LOAD ADJUSTING® MAX-AIR®	

### FORD — Pickup F650 y F750

2016 - 17	F650 — Todos Superduty Número de Parte OEM FC4Z18124A o FC4C18124B	—	—	—	—	—	—	—	—
				65183					
2015-17	F650 — Todos Superduty Número de Parte OEM FC4C18124B	—	—	—	—	—	—	—	—
					65185				
2016-17	F750 — Todos Superduty	—	—	—	—	—	—	—	—
				65183					

### FORD — Probe

1989-92	Todos — GL y LX 3.0L V6 c/ Trans. Autom.	—	—	—	—	—	—	—	—
				63619	63619				

### FORD — Ranchero

1972-79	Todos	5801	58182	—	—	32066	—	—	—
---------	-------	------	-------	---	---	-------	---	---	---

### FORD — Ranger

2019-22	4WD — Exc. Paquete Tremor	—	37388●	—	—	—	—	—	—
2000-11	2WD — Todos c/ Susp. Delantera de Barra de Torsión	37122	37014	34804	—	32296	32238	250006●	—
2001-11	2WD — Todos c/ Susp. Delantera de Resorte	37153	37013	—	—	32330	32237	—	250007●
1998-00	2WD — Todos	37153	37013	—	—	32330	32237	—	250007●
1990-97	2WD — Todos	37015	37013	—	—	32235	32237	250005●	250007●
1983-89	2WD — Todos	37011	37013	—	—	32243	32237	—	250007●
2002-11	4WD — Todos c/ Paquete FX4	—	—	—	—	—	—	—	—
1998-11	4WD — Todos	37122	37014	34804	—	32296	32238	250006●	—
1990-97	4WD — Todos Exc. c/ Barra Estabilizadora Trasera	37015	37014	—	—	32235	32238	250005●	—
1983-89	4WD — Todos Exc. c/ Barra Estabilizadora Trasera	—	37014	—	—	—	32238	—	—

### FORD — Taurus

1986- Feb 94	Sedán	—	—	—	—	—	—	—	—
	Station Wagon Inc. SHO	—	—	63621	63621	—	—	—	—
				63621					

### FORD — Taurus X

2008-09	AWD — Desde 13/08/2008								
	Derecho	72577■	—	—	—	—	—	—	—
	Izquierdo	72576■	—	—	—	—	—	—	—
	Kit de Montaje sin Aislador Superior	—	—	906962	—	—	—	—	—
	Kit de Montaje con Aislador Superior	—	—	909914	—	—	—	—	—
	Aislador de Resorte Inferior	—	—	907999	—	—	—	—	—

● Nuevo número de parte

■ Número de parte bajo pedido especial

22 Se requiere el juego de piezas AK38 para instalar esta unidad.



## APLICACIONES

	OESpectrum <i>Reflex</i>	GAS-MAGNUM® BASES DE AMORTIGUADOR CUBREPOLVO		MONRO-MATIC PLUS® MONRO-MATIC® HIDRÁULICO		ROADMATIC LOAD ADJUSTING® MAX-AIR®	

### FORD — Taurus X (Cont.)

2008-09 (Cont.)	FWD — Desde 13/08/2008								
	Derecho	72577 ■	72595 ■	—	—	—	—	—	—
	Izquierdo	72576 ■	72595 ■	—	—	—	—	—	—
	Kit de Montaje sin Aislador Superior	—	—	■906962	—	—	—	—	—
	Kit de Montaje con Aislador Superior	—	—	■909914	—	—	—	—	—
	Aislador de Resorte Inferior	—	—	■907999	—	—	—	—	—

### FORD — Tempo

Mar 1985-94	Todos	—	—	—	—	—	—	—	—
1984-Feb 85	Todos	—	—	—	—	—	—	—	—
				Ⓢ63619	Ⓢ63620				

### FORD — Thunderbird

2002-05	Todos	71368	71345	■904972	■904972	—	—	—	—
1992-97	Todos — Exc. Super Coupé	—	5965	■901970	—	—	33134	—	—
				Ⓢ63621					
1989-91	Todos — Exc. Super Coupé	—	—	■901970	—	—	—	—	—
				Ⓢ63621					
1987-88	Todos — Exc. Turbo Coupé	71828 [Ⓢ]	5861	—	—	—	—	—	—
				Ⓢ63620					
1980-86	Todos	71716 [Ⓢ]	5861	—	—	—	—	—	—
				Ⓢ63621					

### FORD — Topaz

Mar 1985-94	Todos	—	—	—	—	—	—	—	—
				Ⓢ63620	Ⓢ63620				

### FORD — Torino y Gran Torino

1968-71	Todos — Exc. Cobra	5809	—	—	—	—	—	—	—
---------	--------------------	------	---	---	---	---	---	---	---

### FORD — Transit

2015-19	Transit 150 — Todos	—	—	553005	66439	—	—	—	—
	Para Remolque	—	—	—	—	—	—	—	58656 ■
2017-19	Transit 250 — Exc. Cargo Van	—	—	553005	66439	—	—	—	—
	Transit 250 — Cargo Van	—	—	553006	66439	—	—	—	—
2015-16	Transit 250 — Exc. Cargo Van	—	—	553005	66451	—	—	—	—
	Transit 250 — Cargo Van	—	—	553006	66451	—	—	—	—
2014-18	Transit Connect Van								
	Derecho	72787	37345	■908961	—	—	—	—	—
	Izquierdo	72788	37345	■908961	—	—	—	—	—
	Para Remolque	—	—	—	—	—	—	—	58658
2010-13	Transit Connect Van	72479 <sup>H</sup>	37311	■908900	—	—	—	—	—
	Para Remolque	—	—	—	—	—	—	—	58657
				Ⓢ63631					
2006-15	Transit Connect — Panel Van	—	37367	—	—	—	—	—	—
	Transit Connect — Open Bed Van	—	37375	—	—	—	—	—	—
	Transit Connect — Todos	72996	—	—	—	—	—	—	—
1999-01	Transit Connect — Todos	72479 <sup>H</sup>	37311	■908900	—	—	—	—	—

■ Número de parte bajo pedido especial

[Ⓢ] El compresor de resorte NO ES necesario para reemplazar los struts en este vehículo.

[Ⓢ] Unidad Premium hidráulica, el vástago no se extenderá por sí mismo ya que este número de parte no contiene gas.

[T] Puede que se requiera el juego de piezas AK27 para reemplazar los tornillos y las tuercas originales del montaje inferior si están dañados o si no es posible reutilizarlos.



## APLICACIONES

		<b>GAS-MAGNUM®</b> BASES DE AMORTIGUADOR CUBREPOLVO		<b>MONRO-MATIC PLUS®</b> MONRO-MATIC® HIDRÁULICO		<b>ROADMATIC</b> LOAD ADJUSTING® MAX-AIR®	

### FORD — Club Wagon

1997-98	Todos	—	—	—	—	32259R	32260R	—	—
---------	-------	---	---	---	---	--------	--------	---	---

### FORD — Van Serie E

2008-14	Van (1/2 Ton) E-150 — Todos	37116	37117	34760	34761	32267R	32268R	—	—
1992-07	Van (1/2 Ton) E-150 — Todos Inc. Club Wagon	911128	—	34796	34759	32259R	32260R	—	—
1975-91	Van (1/2 Ton) E-150, E-100 — Todos Inc. Club Wagon Para Remolque	—	—	34899	34911	1419	—	—	—
1992-14	Van (3/4 Ton) E-250 — Todos c/ 8,600 lb. PBV Inc. Club Wagon	—	—	34760	34761	32267R	32268R	—	—
1992-06	Van (3/4 Ton) E-250 — Todos Inc. Club Wagon — Exc. c/ 8,600 lb. PBV	37116	37117	34760	34761	32267R	32268R	—	—
1975-91	Van (3/4 Ton) E-250 — Todos Inc. Club Wagon	—	—	34900	34901	32075R	32284R	—	—
1992-22	Van (1 Ton) E-350 — Ambulancia y Paq. Recreacional Para Remolque	—	—	555031	555032	—	—	—	—
		—	—	—	555010	—	—	—	—
	Van (1 Ton) E-350 — Todos Inc. Club Wagon, Econoline — Exc. Ambulancia Para Remolque	—	—	34760	34761	32267R	32268R	—	—
1975-91	Van (1 Ton) E-350 — Todos Inc. Club Wagon	—	—	34900	34901	32075R	32284R	—	—
2007-08	Van (1 Ton) E-350 Econoline — Todo	—	—	34760	34761	32267R	32268R	—	—

### FORD — Van Econoline

2010-14	Todos — Van	—	—	34760	34761	32267R	32268R	—	—
	Todos — Wagon	911128	—	34796	34759	32259R	32260R	—	—

### FORD — Windstar (Mini Van)

1995-03	Todos — c/ Resorte de Aire Trasero	71920	—	902910 <sup>[70]</sup>	—	—	—	—	—
				63621	—	—	—	—	—
1994-03	Todos — Exc. c/ Resorte de Aire Trasero	71920	37110	902910 <sup>[70]</sup>	—	—	32275	—	—
				63621	—	—	—	—	—

### GMC — Acadia

2013-16	Todos	—	37315	907986	—	—	—	—	250020●
	Aislador de Resorte Superior	—	—	909923	—	—	—	—	—
	Aislador de Resorte Inferior	—	—	909924	—	—	—	—	—
				63631	—	—	—	—	—
2007-12	Todos	72518	37315	907986	—	—	—	400018●	250020●
	Aislador de Resorte Superior	—	—	909923	—	—	—	—	—
	Aislador de Resorte Inferior	—	—	909924	—	—	—	—	—
		—	—	63631	—	—	—	—	—

### GMC — Canyon Pickup

2021-22	AT4	72919	37351	902052● [277]	—	—	—	—	—
---------	-----	-------	-------	------------------	---	---	---	---	---

● Nuevo número de parte

■ Número de parte bajo pedido especial

R Monro-Matic Plus Reforzado

[70] El balero 901902 está disponible cuando se necesite reemplazar el balero solamente.



## APLICACIONES

		BASES DE AMORTIGUADOR CUBREPOLVO		MONRO-MATIC® HIDRÁULICO		LOAD ADJUSTING MAX-AIR®	

### GMC — Canyon Pickup (Cont.)

2021-22 (Cont.)	Denali, Elevation, Elevation Standard	72919	37351	902052●	—	—	—	—	—
2015-20	Todos	72919	37351	902052●	—	—	—	—	—
2004-12	2WD — Todos c/ Susp. Delantera de Resorte	71353	911228	—	—	—	—	—	—
	2WD — Todos c/ Susp. Delantera de Barra de Torsión	911229	911230	—	—	33178	33179	—	—
2015	4WD — Todos	—	37351	—	—	—	—	—	—
2004-12	4WD — Todos	911229	911230	—	—	—	—	—	—

### GMC — Envoy

2002-09	2WD y 4WD XL y XUV — Todos c/ Suspensión Trasera de Aire	71341	37242	904968	—	—	—	—	—
	2WD y 4WD XL y XUV — Todos c/ Suspensión Trasera de Resorte	71341	37241	904968	—	—	—	—	—
2000-01	2WD XL y XUV — Todos	37129	37021	—	—	32300	32186	250300	250186
1998-01	4WD XL y XUV — Todos	37099	37021	—	—	32194	32186	250194	250186

### GMC — LLV

1987-95	Todos	—	—	34945	34934	—	—	—	—
---------	-------	---	---	-------	-------	---	---	---	---

### GMC — Pickup Sierra 1500

2019-22	2WD (1/2 Ton) 1500 — Exc. Denali, Limited Para Remolque	73116●	911533	—	—	—	—	—	—
	Para Remolque	—	—	—	—	—	—	—	58654
	Para Remolque	—	—	—	—	—	—	—	MA834■
2019	2WD (1/2 Ton) 1500 Limited Aislador Superior y Cubrepolvo	39112	911533	902035	552001	—	—	—	—
	Para Remolque	—	—	907942	—	—	—	—	—
	Para Remolque	—	—	—	—	—	—	—	58654
2014-18	2WD (1/2 Ton) 1500 — Exc. Z95 Aislador Superior y Cubrepolvo	39112	911533	902035	552001	—	—	—	—
	Para Remolque	—	—	907942	—	—	—	—	—
	Para Remolque	—	—	—	—	—	—	—	58654
2007-13	2WD (1/2 Ton) 1500 — Exc. HD y c/ Suspensión Electrónica	39105	911533	905910	552001	—	—	—	—
	Aislador Superior y Cubrepolvo	—	—	907942	—	—	—	—	—
	Para Remolque	—	—	—	—	—	—	—	58654
2005-07	2WD (1/2 Ton) 1500HD — Todos Crew Cab c/ Susp. Del. de Barra de Torsión Exc. c/ Sist. de Manejo Elect. Y Quadrasteer	911181	911164	34504	34960	32350R	32341	—	—
	Para Remolque	—	—	—	—	—	—	—	—
	Para Remolque	—	—	—	—	—	—	—	58638■

● Nuevo número de parte

R Monro-Matic Plus Reforzado

■ Número de parte bajo pedido especial



# APLICACIONES

	<b>OESpectrum</b>	<b>GAS-MAGNUM®</b>		<b>MONRO-MATIC PLUS®</b>		<b>ROADMATIC</b>	
	<b>Reflex</b>	BASES DE AMORTIGUADOR CUBREPOLVO		MONRO-MATIC® HIDRÁULICO		LOAD ADJUSTING MAX-AIR®	

## GMC — Pickup Sierra 1500 (Cont.)

1999-07	2WD (1/2 Ton) 1500 — Serie Clásica Exc. Modelos HD y c/ Control de Manejo Elect. Monotubo para Alto Desempeño Para Remolque Para Remolque	911149 911503	911150 911504	34675 —	34676 —	32326R —	32327R —	— —	— —
2001-03	2WD (1/2 Ton) 1500HD — Todos Crew Cab c/ Susp. Del. de Barra de Torsión Para Remolque	911181	911164	34504	34690	32350R	32341	—	— 58638 ■
2019-22	4WD (1/2 Ton) 1500 — Exc. Denali, Limited y AT4 Para Remolque Para Remolque	73116 ●	911533	—	—	—	—	—	— 58654 MA834 ■
2019	4WD (1/2 Ton) 1500 Limited — Exc. Z95 Magnetic Ride Control Aislador Superior y Cubrepolvo Para Remolque Para Remolque	39112	911533	902035 907942	552001 —	—	—	—	— 58654 MA834 ■
2014-18	4WD (1/2 Ton) 1500 — Todos Exc. Z95 Aislador Superior y Cubrepolvo Para Remolque Para Remolque	39112	911533	902035 907942	552001 —	—	—	—	— 58654 MA834 ■
2007-13	4WD (1/2 Ton) 1500 — Exc. 1500HD y Suspensión Electrónica Aislador Superior y Cubrepolvo Para Remolque Para Remolque	39105	911533	905910 907942	552001 —	—	—	—	— 58654 MA834 ■
2005-07	4WD (1/2 Ton) 1500HD — Todos Crew Cab y Clásica Exc. c/ Control de Manejo Para Remolque	911181	911164	34504	34690	32350R	32341R	—	— 58638 ■
2000-07	4WD (1/2 Ton) 1500 — Todos c/ ZX3 o c/ FW1 Sistema de Manejo Electrónico y Clásico Exc. Modelos HD	40038 ■	—	—	—	—	—	—	—
1999-07	4WD (1/2 Ton) 1500 — Todos Exc. 1500HD y c/ Control de Manejo Electrónico Monotubo para Alto Desempeño Para Remolque	911151 911501	911152 911502	34677 —	34678 —	32328R —	32329R —	— —	— — 58637 ■

● Nuevo número de parte

R Monro-Matic Plus Reforzado

■ Número de parte bajo pedido especial





## APLICACIONES

	<b>OESpectrum</b>	<b>GAS-MAGNUM®</b>	<b>MONRO-MATIC PLUS®</b>		<b>ROADMATIC</b>	
	<b>Reflex</b>	BASES DE AMORTIGUADOR CUBREPOLVO	MONRO-MATIC® HIDRÁULICO		LOAD ADJUSTING® MAX-AIR®	

### GMC — Pickup Sierra 1500 (Cont.)

1999-07 (Cont.)	4WD (1/2 Ton) 1500 — Todos c/ Paquete Off-Road Z71 Exc. 1500HD y c/ Control de Manejo Elect. Monotubo para Alto Desempeño	—	—	—	—	—	—	—	—
		911501	911502	—	—	—	—	—	—

### GMC — Pickup Sierra 2500

2011-22	2WD (3/4 Ton) 2500 — Todos Modelos HD c/ 9,200 lb. PBV	911447	911303	34810	34811	—	—	—	—
2000-10	2WD (3/4 Ton) 2500 — Todos Modelos HD c/ 9,200 lb. PBV	911181	37164 911164	34504	34690	32350R	32341R	—	—
1999-04	2WD (3/4 Ton) 2500 — Todos Hasta 8,600 lb. PBV — Exc. c/ Paq. Quadrateer Para Remolque	37163	37164 911164	34689	34690	32340R	32341R	—	—
		—	—	—	—	—	—	—	58638■
2011-22	4WD (3/4 Ton) 2500HD — Todos c/ 9,200 lb. PBV	911447	911303	34810	34811	—	—	—	—
2000-10	4WD (3/4 Ton) 2500HD — Todos	911181	911164	34504	34690	32350R	32341R	—	—
1999-04	4WD (3/4 Ton) 2500 — Todos (Hasta 8,600 lb. PBV) — Exc. c/ Paq. Quadrateer Para Remolque	911181	911164	34504	34690	32350R	32341R	—	—
		—	—	—	—	—	—	—	58638■

### GMC — Pickup Sierra 2500 Amortiguador de Dirección

		Sin Soporte	Con Soporte
2011-15	2500HD 3/4 Ton. 2WD y 4WD — Reemplaza # OEM 25888044	SC2969	—

### GMC — Pickup Sierra 3500

2011-22	2WD (1 Ton) 3500HD — Chassis Cab	911447	—	34810	34812	—	—	—	—
	2WD (1 Ton) 3500HD — Exc. Chassis Cab	911447	911303	34810	34811	—	—	—	—
2001-10	2WD (1 Ton) 3500 — Todos c/ Susp. Delantera Independiente	911181	911168	34504	34694	32350R	32345R	—	—
1991-03	2WD (1 Ton) 3500HD — Todos Modelos HD c/ Eje de Viga Delantero en I	—	—	34755	34756	—	—	—	—
2011-22	4WD (1 Ton) 3500 — Exc. Chassis Cab	911447	911303	34810	34811	—	—	—	—
	4WD (1 Ton) 3500HD — Chassis Cab.	911447	—	34810	34812	—	—	—	—
2001-10	4WD (1 Ton) 3500 — Todos Inc. Chassis Cab.	911181	911168	34504	34694	32350R	32345R	—	—

### GMC — Pickup Sierra 3500 Amortiguador de Dirección

		Sin Soporte	Con Soporte
2011-15	3500 1 Ton. 2WD y 4WD — Reemplaza # OEM 25888044	SC2969	—

### GMC — Pickup Series C, R, K y V

1987-02	2WD (1/2 Ton) C-1500 — Todos	911050	911044	34983	34985	32224R	32225R	250224	—
1973-87	2WD (1/2 Ton) C-10, C-10 — Todos	37049	37041	34817	34824	33033R 1414	33084R 1415	—	—

■ Número de parte bajo pedido especial

R Monro-Matic Plus Reforzado



## APLICACIONES

	<b>OESpectrum</b>	<b>GAS-MAGNUM®</b>	<b>MONRO-MATIC PLUS®</b>		<b>ROADMATIC</b>	
	<b>Reflex</b>	<b>BASES DE AMORTIGUADOR</b> CUBREPOLVO	<b>MONRO-MATIC® HIDRÁULICO</b>		<b>LOAD ADJUSTING®</b> MAX-AIR®	

### GMC — Pickup Series C, R, K y V (Cont.)

1963-72	2WD (1/2 Ton) C-10 — Todos Exc. c/ Susp. Trasera de Resorte	37049	—	34817	34803	33033R 1414	31000 1412	—	—
1987-00	2WD (3/4 Ton) C-2500 — Todos Exc. Modelos HD	911050	911044	34983	34985	32224R	32225R	250224	—
	2WD (3/4 Ton) C-2500 — Todos Modelos HD c/ 8,600 lb. PBV	911050	911044	34741	34985	32362R	32225R	—	—
1973-89	2WD (3/4 Ton) C-20, C-20, C-2500 — Todos	37049	37041	34817	34824	—	—	—	—
1992-00	2WD (1 Ton) C-3500 — Todos	911050	911044	34741	34985	32362R	32225R	—	—
1973-91	2WD (1 Ton) C-30, C-30, C-3500 — Todos	—	—	34817	34960	33033R	—	—	—
1987-99	4WD (1/2 Ton) K-1500 — Todos Monotubo para Alto Desempeño	911043	911044	34798	34985	32263R	32225R	—	—
		911511	911512	—	—	—	—	—	—
1981-87	4WD (1/2 Ton) K-10 y V-10 — Todos c/ Susp. Quad Delantero Interior (2 requeridos) Delantero Exterior (2 requeridos)	—	37041	34910	34824	33086R	33084R	—	—
		37040	37041	34944	34824	—	33084R	—	—
1973-87	4WD (1/2 Ton) K-10 y V10 — Todos Exc. Susp. Quad	37040	37041	34944	34824	—	—	—	—
1987-00	4WD (3/4Ton) K-2500 Todos — Exc. c/ 8,600 lb. PBV	911043	911044	34798	34985	32263R	32225R	—	—
		911190■	911044	34799	34985	32373R	32225R	—	—
1981-86	4WD (3/4 Ton) K-20 y V-20 — Todos c/ Susp. Quad Delantero Interior (2 requeridos) Delantero Exterior (2 requeridos)	—	37041	34910	34824	—	—	—	—
		37040	—	34944	—	—	—	—	—
1973-86	4WD (3/4 Ton) K-20 Todos — Exc. c/ Susp. Quad	37040	37041	34944	34824	—	—	—	—
1969-72	4WD (3/4 Ton) K-20 — Todos	—	—	34944	34822	—	—	—	—
1987-00	4WD (1 Ton) K-3500 — Todos	911190■	911044	34799	34985	32373R	32225R	—	—
1977-91	4WD (1 Ton) V-30, V-3500, K-30 — Todos	—	—	34919■	34920■	—	—	—	—

### GMC — Pickup Series C, R, K y V Amortiguador de Dirección

		Sin Soporte	Con Soporte
1967-69	K-1500 1/2 Ton. 4WD	SC2917 <sup>[33]</sup> <sup>[34]</sup> <sup>[33]</sup> <sup>[34]</sup>	—
1960-66	K-1500 1/2 Ton. 4WD	SC2917 <sup>[33]</sup> <sup>[34]</sup> <sup>[33]</sup> <sup>[34]</sup>	—
1967-69	K-2500 3/4 Ton. 4WD	SC2917 <sup>[33]</sup> <sup>[34]</sup> <sup>[33]</sup> <sup>[34]</sup>	—
1960-66	K-1500 3/4 Ton. 4WD	SC2917 <sup>[33]</sup> <sup>[34]</sup> <sup>[33]</sup> <sup>[34]</sup>	—
1967-69	Suburban K-1500 Series 1/2 Ton 4WD	SC2917 <sup>[33]</sup> <sup>[34]</sup> <sup>[33]</sup> <sup>[34]</sup>	—

■ Número de parte bajo pedido especial

R Monro-Matic Plus Reforzado

[33] Se venden los cilindros como cilindros de repuesto para los juegos de estabilizador de dirección.

[34] Juego de fuelle SA-19XX está disponible para el uso con nuestros cilindros de estabilizador de dirección.



## APLICACIONES

	<b>OESpectrum</b> <i>Reflex</i>	<b>GAS-MAGNUM®</b> BASES DE AMORTIGUADOR CUBREPOLVO	<b>MONRO-MATIC PLUS®</b> MONRO-MATIC® HIDRÁULICO	<b>ROADMATIC</b> LOAD ADJUSTING® MAX-AIR®

### GMC — Pickup Series C, R, K y V (Cont.) Amortiguador de Dirección

		Sin Soporte	Con Soporte
1960-66	Suburban K-1000 Series 1/2 Ton 4WD	SC2917 <sup>[33]</sup> <sup>[34]</sup> <sup>[33]</sup> <sup>[34]</sup>	—
1967-69	Suburban K-2500 Series 3/4 Ton 4WD	SC2917 <sup>[33]</sup> <sup>[34]</sup> <sup>[33]</sup> <sup>[34]</sup>	—
1960-66	Suburban K-1500 Series 3/4 Ton 4WD	SC2917 <sup>[33]</sup> <sup>[34]</sup> <sup>[33]</sup> <sup>[34]</sup>	—

### GMC — Savana

2009-16	Todos — Van 4500	—	—	34530	34532	—	—	—	—
---------	------------------	---	---	-------	-------	---	---	---	---

### GMC — Sonoma 2WD

1994-05	2WD — Todos Exc. c/ Paquete ZQ8	37129	37021	—	—	32300	32186	250300	250186
1982-93	2WD — Todos	37019	37021	34945	34934	32194	32186	250194	250186
1994-05	4WD Todos — Exc. c/ Paquete ZR2	37099	37021	—	—	32194	32186	250194	250186
1994-03	4WD — Todos c/ Paquete ZR2	911514	—	—	—	—	—	—	—
1983-93	4WD — Todos	37099	37021	34740	—	32194 1401	32186	250194	250186

### GMC — Terrain

2018-21	Todos	—	37390●	—	—	—	—	—	—
---------	-------	---	--------	---	---	---	---	---	---

### GMC — Yukon

2015-20	2WD y 4WD — Exc. Paquete Z95, Patrulla y Paquete Z85	39112	911506	902035	—	—	—	—	—
	Aislador Superior y Cubrepolvo	—	—	907942	—	—	—	—	—
2015-20	2WD y 4WD — c/ Paquete Z85 — Exc. Paq. Z95 y Patrulla	39112	—	902035	—	—	—	—	—
	Aislador Superior y Cubrepolvo	—	—	907942	—	—	—	—	—
2007-14	2WD y 4WD — Exc. c/ Susp. Z55 y Suspensión Nivomat	39104	911506	905910	—	—	—	—	—
	Aislador Superior y Cubrepolvo	—	—	907942	—	—	—	—	—
2001-06	2WD y 4WD — Exc. c/ Susp. Z55 y c/ Susp. Nivomat	911178	911166	34501	34692	32347R	32348R	—	—
	Monotubo para Alto Desempeño	911505	911506	—	—	—	—	—	—
	2WD — Todos c/ Susp. Z55	40044	40034	—	—	—	—	—	—
	4WD — Todos c/ Susp. Z55 Exc. Premium Smooth Ride (ZW7)	40044	40050	—	—	—	—	—	—
2001-06	2WD y 4WD — Todos c/ Susp. Nivomat — Exc. c/ Susp. Z55	911178	40210■	34501	—	32347R	—	—	—
1995-99	4WD — Todos 4 puertas Inc. Denali	911043	—	34798	34763	32263R	—	—	—

### HONDA — Accord

2018-22	Todos — Exc. Touring, Hybrid Touring	—	5559●	—	—	—	—	—	—
---------	--------------------------------------	---	-------	---	---	---	---	---	---

- Nuevo número de parte
- Número de parte bajo pedido especial
- R Monro-Matic Plus Reforzado

- [33] Se venden los cilindros como cilindros de repuesto para los juegos de estabilizador de dirección.
- [34] Juego de fuelle SA-19XX está disponible para el uso con nuestros cilindros de estabilizador de dirección.

## APLICACIONES

	<b>OESpectrum</b> <i>Reflex</i>		<b>GAS-MAGNUM®</b> BASES DE AMORTIGUADOR CUBREPOLVO		<b>MONRO-MATIC PLUS®</b> MONRO-MATIC® HIDRÁULICO		<b>ROADMATIC</b> LOAD ADJUSTING® MAX-AIR®	

### HONDA — Accord (Cont.)

2016-17	Todos — Exc. Híbrido								
	Derecho	72970	72984	—	—	—	—	—	—
	Izquierdo	72971	72984	—	—	—	—	—	—
	Plato	—	—	—	902055●	—	—	—	—
				⚡63638	⚡63628				
2013-15	Todos — Exc. Híbrido								
	Derecho	72970	72984	902056●	—	—	—	—	—
	Izquierdo	72971	72984	902056●	—	—	—	—	—
				⚡63638	⚡63628				
2016-17	Todos — Híbrido								
	Derecho	72970	—	—	—	—	—	—	—
	Izquierdo	72971	—	—	—	—	—	—	—
				⚡63638	⚡63628				
2013-15	Todos — Híbrido								
	Derecho	72970	—	902055●	—	—	—	—	—
	Izquierdo	72971	—	902055●	—	—	—	—	—
				⚡63638	⚡63628				
2008-12	Todos	72562	72563	⚡901940®	⚡901940®	—	—	—	—
	Plato de Apoyo Derecho	—	—	⚡909918	—	—	—	—	—
	Plato de Apoyo Izquierdo	—	—	⚡909917	—	—	—	—	—
	Aislador de Resorte Superior	—	—	⚡909922	—	—	—	—	—
				⚡63628	⚡63629				
2003-07	Todos — Híbrido	72123 <sup>EL</sup>	—	⚡901940®	⚡901940®	—	801372	—	—
	Sedán y Coupé	72123 <sup>EL</sup>	—	⚡901940®	⚡901940®	—	—	—	—
				⚡63628	⚡63629				
1998-02	Todos	71691 <sup>EL</sup>	—	⚡901940®	⚡901940®	—	—	—	—
				⚡63628					
1994-97	Todos	—	—	⚡901940®	⚡901961	—	—	—	—
				⚡63628	⚡63636				
1990-93	Todos	—	—	⚡901940®	⚡901961	—	—	—	—
				⚡63628	⚡63636				
1986-89	Todos	71829 <sup>EL</sup>	—	⚡901940®	⚡901961	—	—	—	—

### HONDA — Accord Crosstour

2012-2015	Todos — Modelo EX-L y EX c/ Motor de 3.5	73082●	—	—	—	—	—	—	—
2010-11	Todos — Modelos EX-L y EX	73082●	73087●	—	—	—	—	—	—

### HONDA — City

2009-14	Todos	—	5682	—	—	—	—	—	—
---------	-------	---	------	---	---	---	---	---	---

### HONDA — Civic

2021-22	Sedán	73081●	5545	—	—	—	—	—	—
2017-21	Hatchback — Exc. Type R	—	5545	—	—	—	—	—	—
2016-20	Sedán y Coupe, Todos — Exc. Type R y Si	73081●	5545	—	—	—	—	—	—
2012-15	Coupe — Exp. Si								
	Derecho	72927	5505	⚡902011	—	—	—	—	—
	Izquierdo	72928	5505	⚡902011	—	—	—	—	—
				⚡63631					

● Nuevo número de parte

Ⓜ Este número de pieza es una marca registrada de Tenneco y no se puede usar ni reproducir sin permiso.

EL Unidad Premium que son considerados con vástago de extensión lenta.



## APLICACIONES

				BASES DE AMORTIGUADOR CUBREPOLVO		MONRO-MATIC® HIDRÁULICO		LOAD ADJUSTING® MAX-AIR®	

### HONDA — Civic (Cont.)

2012-15 (Cont.)	Todos — Exp. Si e Híbrido								
	Derecho	72925	5698	—	—	—	—	—	—
	Izquierdo	72926	5698	—	—	—	—	—	—
	Aislador de Resorte Inferior Izquierdo	—	—	907956	—	—	—	—	—
2006-11	Sedán — Exc. Si								
	Derecho	72286	5609	906964	—	—	33185	—	—
	Izquierdo	72287	5609	906964	—	—	33185	—	—
	Aislador de Resorte Inferior Izquierdo	—	—	907956	—	—	—	—	—
	Aislador Superior delantero	—	—	909945 63631	—	—	—	—	—
	Coupé — Si	—	5504	906964 63631	—	—	—	—	—
2003-05	Todos — Exc. SI Hatchback e Híbrido								
	Derecho	72185	71340	904996	901940®	—	801340	—	—
	Izquierdo	72186	71340	904997	901940®	—	801340	—	—
	Aislador de Resorte Superior	—	—	— 63638■	907914	—	—	—	—
2002-05	Todos — SI Hatchback								
	Derecho	—	71340	906919	901940®	—	801340	—	—
	Izquierdo	—	71340	906920	901940®	—	801340	—	—
	Aislador de Resorte Superior	—	—	— 63633	907914	—	—	—	—
2002	Todos — Exc. SI Hatchback								
	Derecho	—	71340	904996	901940®	801433	801340	—	—
	Izquierdo	—	71340	904997	901940®	801434	801340	—	—
	Aislador de Resorte Superior	—	—	— 63631	907914	—	—	—	—
2001	Todos								
	Derecho	—	71340	906919	901940®	801433	801340	—	—
	Izquierdo	—	71340	906920	901940®	801434	801340	—	—
	Aislador de Resorte Superior	—	—	— 63631	907914	—	—	—	—
1996-00	Todos								
		—	71292 <sup>EL</sup>	901940® 63628	901940® 63628	—	—	—	—
1992-95	Sedán, Coupé y Hatchback	—	—	901940® 63628	901940® 63628	—	—	—	—

### HONDA — CR-V

2020-22	AWD								
	Derecho	73097●	37382●	—	—	—	—	—	—
	Izquierdo	73098●	37382●	—	—	—	—	—	—
2017-19	Todos								
	Derecho	73097●	37382●	—	—	—	—	—	—
	Izquierdo	73098●	37382●	—	—	—	—	—	—
2015-16	FWD								
	Derecho	73057■	72957	63640	—	—	—	—	—
	Izquierdo	73058■	72957	63640	—	—	—	—	—
	Plato	—	—	—	902057●	—	—	—	—

● Nuevo número de parte

■ Número de parte bajo pedido especial

® Este número de pieza es una marca registrada de Tenneco y no se puede usar ni reproducir sin permiso.

EL Unidad Premium que son considerados con vástago de extensión lenta.



## APLICACIONES

	<b>OESpectrum</b> <i>Reflex</i>		<b>GAS-MAGNUM®</b> BASES DE AMORTIGUADOR CUBREPOLVO		<b>MONRO-MATIC PLUS®</b> MONRO-MATIC® HIDRÁULICO		<b>ROADMATIC</b> LOAD ADJUSTING® MAX-AIR®	

### HONDA — CR-V (Cont.)

2015-16 (Cont.)	AWD Derecho Izquierdo Plato	73045 73046 —	72957 72957 —	∅63640 ∅63640 —	— — 902057●	— — —	— — —	— — —	— — —
2012-14	Todos Derecho Izquierdo Plato	72491 72492 —	72957 72957 —	∅906966 ∅906966 —	∅901940® ∅901940® 902057●	— — —	— — —	— — —	— — —
2007-11	Todos Derecho Izquierdo Aislador de Resorte Superior Asiento de Resorte Superior	72491 72492 — —	72497 <sup>EL</sup> 72497 <sup>EL</sup> — —	∅906966 ∅906966 — —	∅901940® ∅901940® ∅907914 909959■	802491 802492 — —	802497 802497 — —	— — — —	— — — —
2002-06	Todos Derecho Izquierdo Aislador de Resorte Superior	72143 72144 —	71380 <sup>EL</sup> 71380 <sup>EL</sup> —	∅906919 ∅906920 —	∅901940® ∅901940® ∅907914	802143 802144 —	801380 801380 —	— — —	— — —
1997-01	Todos	—	—	∅901940®	∅901940®	—	—	—	—

### HONDA — Crosstour

2012-15	Modelos EX y EX-L c/ Motor de 3.5L 6 Cil. Plato Izquierdo Plato Derecho Aislador de Resorte Superior	— — — —	73087●	∅901940® ∅909917 ∅909918 ∅909922	∅901940® — — —	— — — —	— — — —	— — — —	— — — —
	Modelos EX y EX-L FWD c/ Motor de 2.4L 4 Cil. Plato Izquierdo Plato Derecho Aislador de Resorte Superior	73083●	73086●	∅901940® ∅909917 ∅909918 ∅909922	∅901940® — — —	— — — —	— — — —	— — — —	— — — —

### HONDA — Element

2007-11	Todos Derecho Izquierdo Asiento de Resorte Superior Aislador de Resorte Superior Plato	— — — — —	— — — — —	∅906919 ∅906920 909927■ ∅909930 —	∅901940® ∅901940® — — 909920■	— — — — —	— — — — —	— — — — —	— — — — —
2003-06	Todos Derecho Izquierdo Asiento de Resorte Superior Aislador de Resorte Superior Plato	— 72136 — — —	— — — — —	∅906919 ∅906920 909927■ ∅909930 909920■	∅901940® ∅901940® — — —	— — — — —	— — — — —	— — — — —	— — — — —

### HONDA — Fit

2009-14	Todos	—	5682	∅906965	—	—	—	—	—
---------	-------	---	------	---------	---	---	---	---	---

● Nuevo número de parte

■ Número de parte bajo pedido especial

® Este número de pieza es una marca registrada de Tenneco y no se puede usar ni reproducir sin permiso.

<sup>EL</sup> Unidad Premium que son considerados con vástago de extensión lenta.



## APLICACIONES



### HONDA — Fit (Cont.)

2006-08	Todos — Exc. Modelos ensamblados en Brasil								
	Derecho	72290	5605		—	—	—	—	—
	Izquierdo	72291	5605		—	—	—	—	—

### HONDA — Insight

2019-22	Todos	73081 ●	—	—	—	—	—	—	—
2010-14	Todos	—	5550 ●		—	—	—	—	—

### HONDA — Odyssey (Mini Van)

2018-22	Todos	—	37387 ●	—	—	—	—	—	—
2013-17	Todos	72982	37316		—	—	—	—	—
2011-12	Odyssey (Mini Van) — Todos								
	Derecho	72560	37316		—	—	—	—	—
	Izquierdo	72561	37316		—	—	—	—	—
2008-10	Todos								
	Derecho	72541	37316		—	—	—	—	—
	Izquierdo	72542	37316		—	—	—	—	—
2005-07	Todos								
	Derecho	72536	37316		—	—	33194	—	—
	Izquierdo	72537	37316		—	—	33194	—	—
	Asiento de Resorte Superior	—	—	909977 ■	—	—	—	—	—
	Aislador de Resorte Superior	—	—	909978 ■	—	—	—	—	—
1999-04	Todos								
	Derecho	71597	37218		—	—	33274	—	—
	Izquierdo	71598	37218		—	—	33274	—	—
	Para Remolque	—	—	—	—	—	—	—	58645 ■
1995-98	Todos	—	—			—	32399	—	—

### HONDA — Pilot

2009-15	Todos								
	Derecho	72647	37339		—	—	—	—	—
	Izquierdo	72648	37339		—	—	—	—	—
2006-08	Todos								
	Derecho	72974	37246		—	—	33192	—	—
	Izquierdo	72975	37246		—	—	33192	—	—
2003-05	Todos	—	37246		—	—	33192	—	—

### HONDA — Ridgeline

2006-14	Todos								
	Derecho	72343	72398			—	—	—	—
	Izquierdo	—	72398			—	—	—	—

### HUMMER — Hummer

2003-09	H2 — Todos	911507	911508	—	—	—	—	—	—
---------	------------	--------	--------	---	---	---	---	---	---

- Nuevo número de parte
- Número de parte bajo pedido especial

® Este número de pieza es una marca registrada de Tenneco y no se puede usar ni reproducir sin permiso.



# APLICACIONES

## HUMMER — Hummer (Cont.)

2006-10	H3 — Todos	911527	911528	—	—	—	—	—	—
---------	------------	--------	--------	---	---	---	---	---	---

## HYUNDAI — Azera

2012-17	Todos	—	5646	908997 63628	—	—	—	—	—
---------	-------	---	------	-----------------	---	---	---	---	---

## HYUNDAI — Elantra

2017-20	Sedan — Exc. Sport	73099 ●	5562 ●	—	—	—	—	—	—
	Derecho	73100 ●	5562 ●	—	—	—	—	—	—
	Izquierdo			63628					
	Sedan — Sport	—	5562 ●	—	—	—	—	—	—
				63628					
2013-17	Hatchback	—	5671 ■	—	—	—	—	—	—
				63632					
2013-14	Coupe								
	Derecho	72708	5671 ■	—	—	—	—	—	—
	Izquierdo	72709	5671 ■	—	—	—	—	—	—
				63632					
2011-16	Sedán								
	Derecho	72708	5671 ■	902018	—	—	—	—	—
	Izquierdo	72709	5671 ■	902018	—	—	—	—	—
				63632					
2009-11	Hatchback								
	Derecho	72305 ■	—	906967 ■	902117 ●	—	—	—	—
	Izquierdo	72306	—	906967 ■	902117 ●	—	—	—	—
	Aislador de Resorte Superior	—	—	909949 ■	—	—	—	—	—
				63631					
2007-10	Sedán								
	Derecho	72305 ■	5622 ■	906967 ■	902117 ●	—	—	—	—
	Izquierdo	72306	5622 ■	906967 ■	902117 ●	—	—	—	—
	Aislador de Resorte Superior	—	—	909949 ■	—	—	—	—	—
				63631					

## HYUNDAI — Entourage

2007-08	Todos								
	Derecho	—	37307 ■	906968 ■	—	—	—	—	—
	Izquierdo	72918 ■	37307 ■	906968 ■	—	—	—	—	—

## HYUNDAI — H100

2006-14	Todos	37368	37369	—	—	—	—	—	—
---------	-------	-------	-------	---	---	---	---	---	---

## HYUNDAI — Santa Fe

2019-20	Todos	—	37341	—	—	—	—	—	—
2013-18	FWD								
	Derecho	73042 ■	37377 ●	—	—	—	—	—	—
	Izquierdo	73043 ■	37377 ●	—	—	—	—	—	—
					63630				
	AWD								
	Derecho	73042 ■	37379 ●	—	—	—	—	—	—
	Izquierdo	73043 ■	37379 ●	—	—	—	—	—	—
				63630					

● Nuevo número de parte

■ Número de parte bajo pedido especial





## APLICACIONES

		GAS-MAGNUM® BASES DE AMORTIGUADOR CUBREPOLVO		MONRO-MATIC PLUS® MONRO-MATIC® HIDRÁULICO		ROADMATIC LOAD ADJUSTING MAX-AIR®	

### HYUNDAI — Santa Fe (Cont.)

2010-12	Todos	—	37322 ■	902037 ■	—	—	—	—	—
	Aislador de Resorte Superior	—	—	902069 ■	—	—	—	—	—
	Aislador de Resorte Inferior	—	—	902070 ■	—	—	—	—	—
				Ⓞ63631					
2007-09	Todos	73047 ●	37322 ■	906968 ■	—	—	—	—	—
	Aislador de Resorte Inferior	—	—	907952 ■	—	—	—	—	—
				63638 ■					
2001-06	Todos	—	—	—	—	—	—	—	—
	Derecho	71435	37237	904957	—	—	—	—	—
	Izquierdo	71436	37237	904957	—	—	—	—	—
	Aislador de Resorte Inferior	—	—	908981 ■	—	—	—	—	—
				Ⓞ63630					

### HYUNDAI — Sonata

2015-19	Hibrido	—	5551 ●	—	—	—	—	—	—
	Todos — Exc. Hibrido	—	—	—	—	—	—	—	—
	Derecho	73072 ●	5551 ●	—	—	—	—	—	—
	Izquierdo	73073 ●	5551 ●	—	—	—	—	—	—
2016	Todos — Hasta 2/17/16 para Eco, Limited 2.0T, Sport 2.0T, Limited, SE, Sport	—	5646	—	—	—	—	—	—
2011-15	Sonata — Hibrido	—	5646	908997	—	—	—	—	—
				Ⓞ63638					
2013-14	Todos — Exc. Hibrido	—	—	—	—	—	—	—	—
	Derecho	72588	5646	908997	—	—	—	—	—
	Izquierdo	72587	5646	908997	—	—	—	—	—
				Ⓞ63638					
2012	Todos — Fabricados desde el 29/11/2011 Exc. Hibrido	—	—	—	—	—	—	—	—
	Derecho	72588	5646	908997	—	—	—	—	—
	Izquierdo	72587	5646	908997	—	—	—	—	—
				Ⓞ63638					
2011	Todos — Fabricados al 22/7/2010 Exc. Hibrido	—	5646	908997	—	—	—	—	—
				Ⓞ63638					

### HYUNDAI — Tucson

2018-21	Todos	—	37386	—	—	—	—	—	—
2016-17	Base, Limited, Ultimate, Eco, GLS Premium, Sport, Luxury, SE, Limited Tech, GLS, Premium, Value	—	37386	—	—	—	—	—	—
2010-15	AWD	—	37341	—	—	—	—	—	—
				Ⓞ63631	Ⓞ63631				
	FWD	—	37343	—	—	—	—	—	—
				Ⓞ63631	Ⓞ63631				

### HYUNDAI — Veloster

2012-15	Todos	—	5671 ■	902018	—	—	—	—	—
---------	-------	---	--------	--------	---	---	---	---	---

● Nuevo número de parte

■ Número de parte bajo pedido especial



## APLICACIONES

### HYUNDAI — Veracruz

2007-12	Todos	72639●	37322■	—	—	—	—	—	—
	Aislador de Resorte Inferior	—	—	907952■	—	—	—	—	—
				63630					

### INFINITI — EX35

2008-12	EX35 — AWD	—	37376■	—	—	—	—	—	—
2009-12	FX35 — AWD								
	Derecho	72702■	37365■	—	—	—	—	—	—
	Izquierdo	72703■	37365■	—	—	—	—	—	—

### INFINITI — FX37

2013	FX37 — AWD								
	Derecho	72702■	—	—	—	—	—	—	—
	Izquierdo	72703■	—	—	—	—	—	—	—

### INFINITI — FX50

2009-11	FX50 — AWD								
	Derecho	72702■	37365■	—	—	—	—	—	—
	Izquierdo	72703■	37365■	—	—	—	—	—	—

### INFINITI — G20

1999-02	G20 — Sedán	—	—	903911■	903911■	—	—	—	—
				63628	63628				
1991-96	G20 — Sedán	—	—	903911■	—	—	—	—	—
					63619				

### INFINITI — G25

2011-12	Todos	—	5654■	—	—	—	—	—	—
---------	-------	---	-------	---	---	---	---	---	---

### INFINITI — G35

2007-08	Sedán AWD y RWD — Exc. Dirección a las 4 llantas	—	5654■	—	—	—	—	—	—
2006-07	RWD Coupé — Exc. c/ Susp. Sport								
	Derecho	71116■	—	905985	—	—	—	—	—
	Izquierdo	71117■	—	905985	—	—	—	—	—
2003-06	RWD Sedán								
	Derecho	71116■	5631■	905985	—	—	—	—	—
	Izquierdo	71117■	5631■	905985	—	—	—	—	—
2006-07	RWD Coupé c/ Susp. Sport	—	—	905985	—	—	—	—	—
2004-06	Todos — AWD								
	Derecho	71144■	5631■	905985	—	—	—	—	—
	Izquierdo	71143■	5631■	905985	—	—	—	—	—
2003-05	RWD y Coupé — Exc. c/ Susp. Sport								
	Derecho	—	5631■	905985	—	—	—	—	—
	Izquierdo	72117	5631■	905985	—	—	—	—	—
	RWD Coupé c/ Susp. Sport	—	5795	905985	—	—	—	—	—

### INFINITI — G37

2009-13	Sedán AWD y RWD— Exc. Dirección a las 4 llantas	—	5654■	—	—	—	—	—	—
	Coupé AWD — Exc. Dirección a las 4 llantas e IPL	—	5654■	—	—	—	—	—	—

● Nuevo número de parte

■ Número de parte bajo pedido especial



## APLICACIONES

	<b>OESpectrum</b>	<b>GAS-MAGNUM®</b>	<b>MONRO-MATIC PLUS®</b>	<b>ROADMATIC</b>
	<b>Reflex</b>	BASES DE AMORTIGUADOR CUBREPOLVO	MONRO-MATIC® HIDRÁULICO	LOAD ADJUSTING® MAX-AIR®

### INFINITI — G37 (Cont.)

2008-13	Coupé RWD — Exc. Dirección a las 4 llantas e IPL	—	5654■	—	—	—	—	—	—
---------	--	---	-------	---	---	---	---	---	---

### INFINITI — I30, I35

2002-04	Sedán								
	Derecho	71461	71327	906914	—	—	—	—	—
	Izquierdo	71462	71327	906914	—	—	—	—	—
				63631	63628				
2000-01	Sedán	—	71327	906914	—	—	—	—	—
				63631	63628				
1996-99	Sedán	—	71293 <sup>EL</sup>	—	903911■	—	—	—	—
				63622	63628				

### INFINITI — M35

2006-07	RWD — Exc. Susp. Sport	—	—	905985	—	—	—	—	—
---------	------------------------	---	---	--------	---	---	---	---	---

### INFINITI — M45

2006-07	Todos	—	—	905985	—	—	—	—	—
2003-04	Todos	—	—	—	903911■	—	—	—	—

### INFINITI — Q45

1990- Ene 93	Sedán — Exc. c/ Susp. Activa	—	—	—	903911■	—	—	—	—
-----------------	------------------------------	---	---	---	---------	---	---	---	---

### INFINITI — QX56

2011-13	Todos	73048●	—	—	—	—	—	—	—
---------	-------	--------	---	---	---	---	---	---	---

### INFINITI — QX70

2014-17	Híbrido								
	Derecho	72702■	—	—	—	—	—	—	—
	Izquierdo	72703■	—	—	—	—	—	—	—

### INFINITI — QX80

2014-22	Todos — Exc. Active Body Control	73048●	—	907932	—	—	—	—	—
---------	----------------------------------	--------	---	--------	---	---	---	---	---

### ISUZU — Amigo

1998-00	Todos	37159	37160	—	—	—	—	—	—
1989-95	Todos	37022	37029	—	—	32217	31094	—	250014●

### ISUZU — Amigo Amortiguador de Dirección

							<b>Sin Soporte</b>	<b>Con Soporte</b>
1989-94	Amigo 2WD — Reemplaza # de E.O. 8-94312814-0						SC2948	—

### ISUZU — Pickup

1989-95	4WD	37022	37029	—	—	32217	31094	—	250014●
---------	-----	-------	-------	---	---	-------	-------	---	---------

### ISUZU — Rodeo

1991-95	Todos	37022	37024	—	—	32217	33049	—	—
---------	-------	-------	-------	---	---	-------	-------	---	---

### ISUZU — Rodeo Amortiguador de Dirección

							<b>Sin Soporte</b>	<b>Con Soporte</b>
1990-96	Rodeo — Reemplaza # de E.O. 8-94312814-0						SC2948	—

### ISUZU — Trooper

1987-91	Todos	37022	37024	—	—	32217	33049	—	—
---------	-------	-------	-------	---	---	-------	-------	---	---

● Nuevo número de parte

■ Número de parte bajo pedido especial

<sup>EL</sup> Unidad Premium que son considerados con vástago de extensión lenta.



## APLICACIONES

	<b>OESpectrum</b>	<b>GAS-MAGNUM®</b>	<b>MONRO-MATIC PLUS®</b>	<b>ROADMATIC</b>
	<b>Reflex</b>	BASES DE AMORTIGUADOR CUBREPOLVO	MONRO-MATIC® HIDRÁULICO	LOAD ADJUSTING® MAX-AIR®

### JAGUAR — S

2000-02	S — Exc. c/ CATS	71366	—	—	—	—	—	—	—
---------	------------------	-------	---	---	---	---	---	---	---

### JAGUAR — X

2002-08	X — Exc. c/ CATS	71391	—	—	—	—	—	—	—
---------	------------------	-------	---	---	---	---	---	---	---

### JEEP — CJ

1982-86	CJ—7 y CJ—7M — Todos	—	—	34958	34803	—	—	—	—
---------	----------------------	---	---	-------	-------	---	---	---	---

#### JEEP — CJ Amortiguador de Dirección

				Sin Soporte	Con Soporte
1973-86	CJ-5, CJ-6 Y CJ-7 (Reemplaza # de E.O.4975423, 4975424)			SC2940	—
1972-79	CJ-5, CJ-6, CJ-7 Sin Estabilizador de dirección OEM			SC2917 <sup>[33]</sup> <sup>[34]</sup> <sup>[3]</sup>	—

### JEEP — Cherokee

2019-22	AWD y 4WD Exc. Susp. Off Road y Trailhawk	—	37394●	∅63631	—	—	—	—	—
	FWD	—	37394●	∅63631	—	—	—	—	—
2014-18	AWD y 4WD Exc. Susp. Off Road y Trailhawk								
	Derecho	72930 <sup>[1170]</sup>	37358	—	—	—	—	—	—
	Izquierdo	72931 <sup>[1170]</sup>	37358	—	—	—	—	—	—
	FWD								
	Derecho	72930 <sup>[1170]</sup>	37358	—	—	—	—	—	—
	Izquierdo	72931 <sup>[1170]</sup>	37358	—	—	—	—	—	—
				∅63631					
1991-01	(XJ) — Todos	37083	37027	—	—	32252	32197	—	—
1984-90	(XJ) — Todos	37026	37027	—	—	32196	32197	—	—

#### JEEP — Cherokee Amortiguador de Dirección

				Sin Soporte	Con Soporte
1984-01	Reemplaza # de E.O. 22025058, 8952002739, J3236097, 52087640, 52087827			SC2928	—
1974-83	Reemplaza # de E.O. 4975500, 5352687, 8129434, J8129434			SC2911	—
	Reemplaza # de E.O. 4975423 y 4975424			SC2940	—

### JEEP — Commander

2006-10	Todos	71377	911278	∏905922	—	—	32407	—	—
	Para Remolque	—	—	—	—	—	—	—	58646■

### JEEP — Compass

2011-17	Todos								
	Derecho	72950	72952	∏907994	∏906959	—	—	—	—
	Izquierdo	72951	72952	∏907994	∏906959	—	—	—	—
				∅63631	∅63628				
2007-10	Todos								
	Derecho	72367	72401 <sup>EL</sup>	∏907994	∏906959	—	802401	400034●	400033●
	Izquierdo	72368	72401 <sup>EL</sup>	∏907994	∏906959	—	802401	400035●	400033●
				∅63631	∅63628				

### JEEP — Grand Cherokee

2016-21	Todos — c/ Resorte Trasero — Exc. SRT8, Susp. De Aire y Susp. Nivomat Trasera	—	911304	—	—	—	—	—	—
---------	---	---	--------	---	---	---	---	---	---

● Nuevo número de parte

■ Número de parte bajo pedido especial

EL Unidad Premium que son considerados con vástago de extensión lenta.

<sup>[33]</sup> Se venden los cilindros como cilindros de repuesto para los juegos de estabilizador de dirección.

<sup>[34]</sup> Juego de fuelle SA-19XX está disponible para el uso con nuestros cilindros de estabilizador de dirección.



## APLICACIONES

		GAS-MAGNUM®		MONRO-MATIC PLUS®		ROADMATIC	
		BASES DE AMORTIGUADOR CUBREPOLVO		MONRO-MATIC® HIDRÁULICO		LOAD ADJUSTING® MAX-AIR®	

### JEEP — Grand Cherokee (Cont.)

2011-15	Todos — c/ Susp. Nivomat Trasera Exc. Susp. de Aire	72546	—	902053●	908999	—	—	—	—
	Todos — c/ Resorte Trasero Exc. Susp. de Aire y Susp. Nivomat Trasera	72546	911304	902053●	908999	—	—	—	—
2005-10	Grand Cherokee (WK) — Exc. SRT8 Para Remolque	71377	911278	905922	—	—	32407	—	—
		—	—	—	—	—	—	—	58646■
1999-04	Todos — Exc. c/ Susp. Up Country Para Remolque	37161	37162	34766	34769	32338	32339	—	—
		—	—	—	—	—	—	—	58647■
1993-98	Todos — Exc. c/ Susp. Up Country	37081	37082	—	—	32252	32269	—	—

### JEEP — Grand Cherokee Amortiguador de Dirección

						Sin Soporte	Con Soporte
1999-04	Reemplaza # de E.O. 52088251, AB					SC2962	—
1983-98	ZJ — Reemplaza # de E.O. 52087827					SC2928	—

### JEEP — Liberty

2002-12	Todos								
	Derecho	71577	37203	905902	—	—	—	400007	250013●
	Izquierdo	71577	37203	905903	—	—	—	400007	250013●

### JEEP — Patriot

2011-17	Todos								
	Derecho	72950	72952	907994	906959	—	—	—	—
	Izquierdo	72951	72952	907994	906959	—	—	—	—
				63631	63628				
2007-10	Todos								
	Derecho	72367	72401 <sup>EL</sup>	907994	906959	—	802401	400034●	400033●
	Izquierdo	72368	72401 <sup>EL</sup>	907994	906959	—	802401	400035●	400033●
				63640	63628				

### JEEP — Pickup S

1966-84	Pickup S—364, Station Wagon, S—169W — Todos	—	—	—	—	31000 1412	31000 1412	250001●	250001●
---------	---	---	---	---	---	---------------	---------------	---------	---------

### JEEP — Renegade

2022	Todos								
	Derecho	73022●	—	—	—	—	—	—	—
	Izquierdo	73021●	—	—	—	—	—	—	—
2019-21	AWD								
	Derecho	73021●	—	—	—	—	—	—	—
	Izquierdo	73022●	—	—	—	—	—	—	—
2015-18	AWD								
	Derecho	73021●	73023●	—	—	—	—	—	—
	Izquierdo	73022●	73024●	—	—	—	—	—	—

### JEEP — Wagoneer (Grand Wagoneer)

1984-91	Todos	—	—	34958	34958	—	—	—	—
1984-90	(XJ) Todos — Exc. Grand Wagoneer	37026	37027	—	—	32196	32197	—	—
1976-83	Todos	—	—	34958	34958	—	—	—	—

● Nuevo número de parte

■ Número de parte bajo pedido especial

EL Unidad Premium que son considerados con vástago de extensión lenta.

## APLICACIONES

	<b>OESpectrum</b>	<b>GAS-MAGNUM®</b>	<b>MONRO-MATIC PLUS®</b>	<b>ROADMATIC</b>
	<b>Reflex</b>	<b>BASES DE AMORTIGUADOR CUBREPOLVO</b>	<b>MONRO-MATIC® HIDRÁULICO</b>	<b>LOAD ADJUSTING® MAX-AIR®</b>

### JEEP — Wrangler

2018-22	Todos JL — Exc. Rubicon, Unlimited Moad, Unlimited Rubicon, Unlimited Sahara	37380●	37381●	—	—	—	—	—	—
2007-18	Todos JK — Exc. 2WD y Rubicon Monotubo para Alto Desempeño	37285 911536	37287 911538	—	—	—	—	—	—
2007-15	Rubicon (JK)—Todos	911536	911539	—	—	—	—	—	—
2007-10	2WD (JK) — Todos Monotubo para Alto Desempeño	37285 911536	37286 —	—	—	—	—	—	—
1996-06	(TJ) — Todos	37026	37135	—	—	32196	32306	—	—
1987-95	(YJ) — Todos	37120	37121	—	—	—	—	—	—

### JEEP — Wrangler Amortiguador de Dirección

		Sin Soporte	Con Soporte
2010-18	Reemplaza # de E.O. 52060058AF	SC2970	—
1987-06	Reemplaza # de E.O. 22025058, 8652-002-739, J3236097, 52087640, 5287827, 52088959,- AA,-60	SC2928	—

### KIA — Amanti

2007-09	Todos	—	5614	905983 63628	905984■	—	—	—	—
2004-06	Todos Plato	—	—	902058● 63628	—	—	—	—	—

### KIA — Cadenza

2014-16	Todos	—	5646	908997	—	—	—	—	—
---------	-------	---	------	--------	---	---	---	---	---

### KIA — Forte

2014-18	Todos	—	5671	—	—	—	—	—	—
2010-13	Todos	—	—	—	—	—	—	—	—
	Derecho	72720■	5672	902038■	—	—	—	—	—
	Izquierdo	72721■	5672	902038■ 63631	—	—	—	—	—

### KIA — Magentis

2006-10	Todos	—	—	—	—	—	—	—	—
	Derecho	71135■	5615■	—	—	—	—	—	—
	Izquierdo	71136■	5615■	—	—	—	—	—	—

### KIA — Optima

2016-20	Todos — Exc. Modelos Híbridos	—	—	—	—	—	—	—	—
	Derecho	73072●	—	—	—	—	—	—	—
	Izquierdo	73073●	—	—	—	—	—	—	—
2012-15	Todos — contruidos en Korea e Híbrido	—	5646	908997	—	—	—	—	—
	Todos — contruidos en USA a partir de 29/11/2011	—	—	—	—	—	—	—	—
	Exc. Híbrido	—	—	—	—	—	—	—	—
	Derecho	72587	5646	908997	—	—	—	—	—
	Izquierdo	72588	5646	908997	—	—	—	—	—
2011	Todos	—	5646	908997	—	—	—	—	—

● Nuevo número de parte

■ Número de parte bajo pedido especial



## APLICACIONES

		GAS-MAGNUM®		MONRO-MATIC PLUS®		ROADMATIC	
		BASES DE AMORTIGUADOR CUBREPOLVO		MONRO-MATIC® HIDRÁULICO		LOAD ADJUSTING® MAX-AIR®	

### KIA — Optima (Cont.)

2006-10	Todos								
	Derecho	71135 ■	5615 ■	—	—	—	—	—	—
	Izquierdo	71136 ■	5615 ■	—	—	—	—	—	—
	Aislador de Resorte Superior	—	—	909999 ■	—	—	—	—	—
				Ⓞ63631					

### KIA — Rio

2012-15	Todos								
	Derecho	72706	5671	—	—	—	—	—	—
	Izquierdo	72707	5671	—	—	—	—	—	—
				Ⓞ63632					
2011-06	Base								
	Derecho	72297	5621	—	⚡906971	—	33209 ●	400030	250021 ●
	Izquierdo	72298	5621	—	⚡906971	—	33209 ●	400031	250021 ●
				Ⓞ63618					
	LX y SX								
	Derecho	72297	5621	⚡906970	⚡906971	—	33209 ●	400030	250021 ●
	Izquierdo	72298	5621	⚡906969	⚡906971	—	33209 ●	400031	250021 ●
	Izquierdo			Ⓞ63618					

### KIA — Rondo

2007-11	Todos								
	Derecho	71135 ■	5615 ■	—	—	—	—	—	—
	Izquierdo	71136 ■	5615 ■	—	—	—	—	—	—
				Ⓞ63631					

### KIA — Sedona

2014	Todos								
	Derecho	—	37307 ■	906968 ■	—	—	—	—	—
	Izquierdo	72918 ■	37307 ■	906968 ■	—	—	—	—	—
2006-12	Todos								
	Derecho	—	37307 ■	906968 ■	—	—	—	—	—
	Izquierdo	72918 ■	37307 ■	906968 ■	—	—	—	—	—
				63638 ■					
2002-05	Todos								
	Derecho	72170	37272 ■	—	—	—	—	—	—
	Izquierdo	—	37272 ■	—	—	—	—	—	—
				Ⓞ63631					

### KIA — Sorento

2014-15	AWD y FWD								
	Derecho	73042 ■	—	—	—	—	—	—	—
	Izquierdo	73043 ■	—	—	—	—	—	—	—
2011-13	Todos								
	Derecho	—	37322 ■	902037 ■	—	—	—	—	—
	Izquierdo	—	37322 ■	902037 ■	—	—	—	—	—
	Aislador de Resorte Superior	—	—	902069 ■	—	—	—	—	—
	Aislador de Resorte Inferior	—	—	902070 ■	—	—	—	—	—
				63638 ■					
2007-09	Todos								
	Derecho	—	37323 ■	905927 ■	—	—	—	—	—
	Izquierdo	71110	37323 ■	905927 ■	—	—	—	—	—
	Plato de Montaje	—	—	902039 ■	—	—	—	—	—

● Nuevo número de parte

■ Número de parte bajo pedido especial

## APLICACIONES

### KIA — Sorento (Cont.)

2003-06	Todos — Exc. c/ Sistema Autonivelable								
	Derecho	—	37281 ■	905927 ■	—	—	—	—	—
	Izquierdo	71110	37281 ■	905927 ■	—	—	—	—	—
	Plato de Montaje	—	—	902039 ■	—	—	—	—	—
	Todos — c/ Sistema Autonivelable Trasero								
	Derecho	—	—	905927 ■	—	—	—	—	—
	Izquierdo	71110	—	905927 ■	—	—	—	—	—
	Plato de Montaje	—	—	902039 ■	—	—	—	—	—

### KIA — Soul

2014-19	Todos — Exc. EV								
	Derecho	73066 ●	5541	—	—	—	—	—	—
	Izquierdo	73067 ●	5541	—	—	—	—	—	—
				⌀63638					
2010-13	Todos								
	Derecho	72968 ■	5657 ■	—	902080 ●	—	—	—	—
	Izquierdo	72969 ■	5657 ■	—	902080 ●	—	—	—	—
				⌀63638					

### KIA — Spectra

2007-09	Todos								
	Derecho	—	72303 ■ ■ ■ [269]	902984 ■	903936 ■	—	—	—	—
	Izquierdo	—	—	902984 ■ ⌀63631	903935 ■ ⌀63628	—	—	—	—
2005-06	Todos								
	Derecho	—	72303 ■	902984 ■	903936 ■	—	—	—	—
	Izquierdo	—	—	902984 ■ ⌀63631	903935 ■ ⌀63628	—	—	—	—
2004	EX, LX								
	Derecho	—	72303 ■	902984 ■	903936 ■	—	—	—	—
	Izquierdo	—	—	902984 ■ ⌀63631	903935 ■ ⌀63628	—	—	—	—

### KIA — Spectra 5

2005-09	Todos								
	Derecho	—	72303 ■	902984 ■	903936 ■	—	—	—	—
	Izquierdo	—	—	902984 ■ ⌀63631	903935 ■ ⌀63631	—	—	—	—

### KIA — Sportage

2011-16	AWD — Exc. SX	72722 ■	37341	—	—	—	—	—	—
	FWD — Exc. SX	72723 ■	37343	—	—	—	—	—	—

### LAND ROVER — Discovery

1999-04	Todos — c/ Susp. de Aire — Exc. c/ ACE	—	37234 ■	—	—	—	—	—	—
	Todos — c/ Susp. de Resorte — Exc. c/ ACE	—	37234 ■	—	—	—	—	—	—
	Todos — c/ Susp. de Aire y ACE	—	37234 ■	—	—	—	—	—	—
	Todos — c/ Susp. de Resorte y ACE	—	37234 ■	—	—	—	—	—	—

● Nuevo número de parte

■ Número de parte bajo pedido especial

[269] Se requiere kit de montaje 903936 para instalar strut





## APLICACIONES

		GAS-MAGNUM®		MONRO-MATIC PLUS®		ROADMATIC	
		BASES DE AMORTIGUADOR CUBREPOLVO		MONRO-MATIC® HIDRÁULICO		LOAD ADJUSTING® MAX-AIR®	

### LEXUS — ES330

2004-06	Todos — Exc. c/ Suspensión AVS								
	Derecho	72205	72207	904989	903904	—	802207	—	—
	Izquierdo	—	72208	904989	903904	—	802208	—	—
				63619	63619				

### LEXUS — GX470

2003-09	Todos — Kit de conversión	—	90022C■	—	—	—	—	—	—
---------	---------------------------	---	---------	---	---	---	---	---	---

### LEXUS — RX330

2004-06	Todos — Exc. Susp. De Aire								
	Derecho	72211■	—	904989	—	802211■	—	—	—
	Izquierdo	72212■	—	904989	—	802212■	—	—	—
				63630	63631				

### LEXUS — RX350

2013-15	Todos — Exc. Susp. De Aire y F Sport								
	Derecho	72765	37361	—	—	—	—	—	—
	Izquierdo	72766	37361	—	—	—	—	—	—
2010-12	Todos — Exc. Susp. De Aire y Susp. Sport								
	Derecho	72765	37361	—	—	—	—	—	—
	Izquierdo	72766	37361	—	—	—	—	—	—
2007-09	Todos — Exc. Susp. De Aire								
	Derecho	72211■	72772■	904989	—	802211■	—	—	—
	Izquierdo	72212■	72773■	904989	905937	802212■	—	—	—
				63630	63631				

### LEXUS — RX400H

2008	AWD								
	Derecho	72211■	—	904989	—	802211■	—	—	—
	Izquierdo	72212■	—	904989	—	802212■	—	—	—
				63630	63631				
	FWD — Exc. Susp. De Aire								
	Derecho	72211■	—	904989	—	802211■	—	—	—
	Izquierdo	72212■	—	904989	—	802212■	—	—	—
				63630	63631				
2006-07	Todos								
	Derecho	72211■	—	904989	—	802211■	—	—	—
	Izquierdo	72212■	—	904989	—	802212■	—	—	—
				63630	63631				

### LINCOLN — Aviator

2003-05	Todos	72293	72294	—	—	—	—	—	—
	Plato de Apoyo	—	—	906918	—	—	—	—	—

### LINCOLN — LS

2003-06	Sedán	71368	71345	904972	904972	—	—	—	—
2000-02	Sedán	71344	71345	904972	904972	—	—	—	—

### LINCOLN — MKC

2015-19	Todos — Exc. Susp. Electrónica								
	Derecho	—	—	908961	906981	—	—	—	—
	Izquierdo	72753	—	908961	906981	—	—	—	—
				63631					

■ Número de parte bajo pedido especial

## APLICACIONES

	<b>OESpectrum</b>	<b>GAS-MAGNUM®</b>		<b>MONRO-MATIC PLUS®</b>		<b>ROADMATIC</b>	
	<b>Reflex</b>	BASES DE AMORTIGUADOR CUBREPOLVO		MONRO-MATIC® HIDRÁULICO		LOAD ADJUSTING® MAX-AIR®	

### LINCOLN — MKS

Jul 2009-12	Todos								
	Derecho	72533	5648	—	—	—	—	—	—
	Izquierdo	72532	5648	—	—	—	—	—	—
	Aislador de Resorte Inferior	—	—	907999	—	—	—	—	—
2009-11	Todos								
	Montura sin aislador superior	—	—	906962	—	—	—	—	—
	Montura con aislador superior	—	—	909914	—	—	—	—	—

### LINCOLN — MKT

2013-19	Todos — Exc. Susp. Controlada electrónicamente								
	Derecho	—	37329	909916	—	—	—	—	—
	Izquierdo	—	37329	909916	—	—	—	—	—
	Aislador de Resorte Inferior	—	—	907999	—	—	—	—	—
				63631					
2010-12	Todos								
	Derecho	72535	37329	—	—	—	—	—	—
	Izquierdo	72534	37329	—	—	—	—	—	—
	Aislador de Resorte Inferior	—	—	907999	—	—	—	—	—

### LINCOLN — MKX

2016-18	Todos — Exc. Susp. Controlada Electrónicamente	73059 ■	37378	63631	—	—	—	—	—
2011-15	Todos								
	Derecho	72888	37327	909906	—	—	33206 ●	—	—
	Izquierdo	72889	37327	909906	—	—	33206 ●	—	—
				63638 ■					
2010	Todos								
	Derecho	72888	37302	—	—	—	—	—	—
	Izquierdo	72889	37302	—	—	—	—	—	—
				63638 ■					
2007-09	Todos								
	Derecho	72888	37302	—	—	—	—	—	—
	Izquierdo	72889	37302	—	—	—	—	—	—
				63638 ■					

### LINCOLN — MKZ

2013-19	Todos	—	—	909981	—	—	—	—	—
2010-12	Todos	72596	5784	905918	—	—	—	—	—
2007-09	Todos	72261 <sup>EL</sup>	5784	905918	—	—	—	—	—

### LINCOLN — Navigator

2018-19	Todos — Exc. Susp. Electronica	—	—	906963	907934	—	—	—	—
2014-17	Todos — Exc. Susp. Electronica y c/ Susp. de nivelación de carga trasera	72900	71139	906963	907934	—	—	—	—
2007-13	2WD y 4WD — Todos Exc. c/ Susp. de nivelación de carga trasera	71138	71139	906963	907934	—	—	—	—
1998-02	2WD — Todos	37131	37154	—	—	—	—	—	—
	4WD — Todos	—	37202	—	—	—	—	—	—

### LINCOLN — Pickup Mark LT

2006-08	2WD — Todos	71362	911261	904970	—	—	—	—	—
---------	-------------	-------	--------	--------	---	---	---	---	---

● Nuevo número de parte

■ Número de parte bajo pedido especial

<sup>EL</sup> Unidad Premium que son considerados con vástago de extensión lenta.



## APLICACIONES

		GAS-MAGNUM®		MONRO-MATIC PLUS®		ROADMATIC	
		BASES DE AMORTIGUADOR CUBREPOLVO		MONRO-MATIC® HIDRÁULICO		LOAD ADJUSTING® MAX-AIR®	

### LINCOLN — Pickup Mark LT (Cont.)

2006-08 (Cont.)	4WD — Todos	71361	911262	904970	550063	—	—	—	—
--------------------	-------------	-------	--------	--------	--------	---	---	---	---

### LINCOLN — Town Car

2003-11	Todos	71346	5993	—	—	—	—	—	—
1986-02	Todos — Exc. Limusina	5960	5961	—	—	33127	33128	—	—

### LINCOLN — Zephyr

2006	Todos	72261 <sup>el</sup>	5784	905918	—	—	—	—	—
------	-------	---------------------	------	--------	---	---	---	---	---

### MAZDA — 2

2011-14	Todos								
	Derecho	72544	5630	907996	907997	—	—	—	—
	Izquierdo	72545	5630	907996	907997	—	—	—	—

### MAZDA — 3

2014-18	Todos								
	Derecho	73015	5540	63640	—	—	—	—	—
	Izquierdo	73016	5540	63640	—	—	—	—	—
2012-13	Todos — Exc. MazdaSpeed								
	Derecho	72263	5683	906980	906981	802263	33210●	—	—
	Izquierdo	72264	5683	906980	906981	802264	33210●	—	—
				63632	63636				
2010-11	Todos — Exc. MazdaSpeed								
	Derecho	72263	5697	906980	906981	802263	—	—	—
	Izquierdo	72264	5697	906980	906981	802264	—	—	—
				63632	63636				
2004-13	Todos — MazdaSpeed	—	—	906980	906981	—	—	—	—
2004-09	Todos — Exc. MazdaSpeed								
	Derecho	72263	5607	906980	906981	802263	—	—	—
	Izquierdo	72264	5607	906980	906981	802264	—	—	—
				63632	63636				

### MAZDA — 5

2012-15	Todos								
	Derecho	72945	5607	906980	906981	—	—	—	—
	Izquierdo	72946	5607	906980	906981	—	—	—	—
				63632	63636				
2006-10	Todos								
	Derecho	72263	5607	906980	906981	—	—	—	—
	Izquierdo	72264	5607	906980	906981	—	—	—	—
				63632	63636				

### MAZDA — 6

2016-17	Todos								
	Derecho	72938	5556●	63640	—	—	—	—	—
	Izquierdo	72939	5556●	63640	—	—	—	—	—
2014	Todos — Vehiculos contruidos hasta el 13/5/2013								
	Derecho	72938	5515	63640	—	—	—	—	—
	Izquierdo	72939	5515	63640	—	—	—	—	—

● Nuevo número de parte

el Unidad Premium que son considerados con vástago de extensión lenta.

## APLICACIONES

	<b>OESpectrum</b>	<b>GAS-MAGNUM®</b>	<b>MONRO-MATIC PLUS®</b>	<b>ROADMATIC</b>
	<b>Reflex</b>	BASES DE AMORTIGUADOR CUBREPOLVO	MONRO-MATIC® HIDRÁULICO	LOAD ADJUSTING® MAX-AIR®

### MAZDA — 6 (Cont.)

2014-15	Todos — Vehículos construidos desde el 13/5/2013								
	Derecho	72938	5556●	63640	—	—	—	—	—
	Izquierdo	72939	5556●	63640	—	—	—	—	—
2009-13	Todos — c/ Motor de 2.5L — Exc. MazdaSpeed								
	Derecho	72568	5656	908994	—	—	—	—	—
	Izquierdo	72569	5656	908994 63640	—	—	—	—	—
	Todos — c/ Motor de 3.7L								
	Derecho	—	5656	908994	—	—	—	—	—
	Izquierdo	—	5656	908994 63640	—	—	—	—	—

### MAZDA — 6i

2005-08	Todos — Exc. MazdaSpeed	—	5784	905918	—	—	—	—	—
2003-04	Todos — Todos	—	5784	905917	—	—	—	—	—

### MAZDA — 6S

2005-08	Todos — Exc. MazdaSpeed	72261 <sup>EL</sup>	5784	—	—	—	—	—	—
2003-04	Todos — Todos	72261 <sup>EL</sup>	5784	—	—	—	—	—	—

### MAZDA — 626 (Cronos)

1983-87	Todos	—	—	63619	63619	—	—	—	—
---------	-------	---	---	-------	-------	---	---	---	---

### MAZDA — CX-5

2017-19	Todos	—	5546	—	—	—	—	—	—
2014-16	Todos — Vehículos construidos desde el 13/05/2013								
	Derecho	72978	5546	—	—	—	—	—	—
	Izquierdo	72979	5546	—	—	—	—	—	—
				63630					
2014	Todos — Vehículos construidos hasta el 13/05/2013								
	Derecho	72978	5530	—	—	—	—	—	—
	Izquierdo	72979	5530	—	—	—	—	—	—
				63630					
2013	Todos								
	Derecho	72978	5530	—	—	—	—	—	—
	Izquierdo	72979	5530	—	—	—	—	—	—
				63630					

### MAZDA — CX-7

2007-12	Todos								
	Derecho	72493	37338	908907	—	—	—	—	—
	Izquierdo	72494	37338	908907 63638■	—	—	—	—	—

● Nuevo número de parte

■ Número de parte bajo pedido especial

EL Unidad Premium que son considerados con vástago de extensión lenta.



## APLICACIONES



### MAZDA — CX-9

2011-15	Todos								
	Derecho	—	37331	908907 63638 ■	—	—	—	—	—
	Izquierdo	72921	37331	908907 63638 ■	—	—	—	—	—
2007-10	Todos								
	Derecho	—	37331	908907	—	—	—	—	—
	Izquierdo	72921	37331	908907 63638 ■	—	—	—	—	—

### MAZDA — MX-5 Miata

2009-12	Todos	—	72496	—	—	—	—	—	—
2006-08	Todos	—	72496	906982	906982	—	—	—	—

### MAZDA — Pickup B2600

1987-93	4WD — Todos	37016	37017	—	—	—	—	—	—
---------	-------------	-------	-------	---	---	---	---	---	---

### MAZDA — RX-8

2004-08	Todos — Exc. Edición 40 Aniversario y Shinka	71122 ■	71123 ■	906982 63628	906982 63628	—	—	—	—
---------	--	---------	---------	-----------------	-----------------	---	---	---	---

### MERCEDES BENZ — Clase C

2010-12	C250 RWD — Exc. 4 Matic	72635	—	—	—	—	—	—	—
2008-12	C350 RWD — Exc. 4 Matic	72635	—	—	—	—	—	—	—
2008-11	C300 RWD — Exc. 4 Matic	72635	—	—	—	—	—	—	—
Mar 2001-07	C230 Kompressor (CL203) Coupé — Exc. c/ Susp. Sport	71486	—	—	—	—	—	—	—
	C230 (CL203) — Coupé c/ Susp. Sport	71488	39047	—	—	—	—	—	—
2003-06	C230 Kompressor (W203) — Sedán	71488	39047	—	—	—	—	—	—
2002-05	C230 Kompressor (CL203) — Coupé	71488	39047	—	—	—	—	—	—
2001-07	C240, C320 (S203) Wagon — Exc. c/ Susp. Sport	71486	39047	—	—	—	—	—	—
	C240, C320 (S203) — Wagon c/ Susp. Sport	71488	39047	—	—	—	—	—	—
May 2000-07	C240, E320 (W203) Sedán — Exc. c/ Susp. Sport	71486	39047	—	—	—	—	—	—
	C240, C320 (W203) — Sedán c/susp. sport	71488	39047	—	—	—	—	—	—
1993-00	C220, C230, C36 (W202) — Sedán Exc. Susp. Sport	39013	—	—	—	—	—	—	—
	C240 (W202) — Sedán Exc. Susp. Sport	39013	—	—	—	—	—	—	—

### MERCEDES BENZ — Clase E

2003-09	E320, E320CDI, E320 Wagon (S211)	39110	—	—	—	—	—	—	—
	E320, E320CDI, E320, E500 Sedán (S211) — Exc. 4Matic, Susp. de Aire y Sport	39110	39108 ■	—	—	—	—	—	—

■ Número de parte bajo pedido especial

## APLICACIONES

	<b>OESpectrum</b>	<b>GAS-MAGNUM®</b>	<b>MONRO-MATIC PLUS®</b>	<b>ROADMATIC</b>
	<b>Reflex</b>	BASES DE AMORTIGUADOR CUBREPOLVO	MONRO-MATIC® HIDRÁULICO	LOAD ADJUSTING® MAX-AIR®

### MERCEDES BENZ — Clase E (Cont.)

2003-09 (Cont.)	E320, E320CDI, E320, E500 Sedán c/ Susp. Deportiva (S211) — Exc. 4Matic, Susp. de Aire	39110	39109■	—	—	—	—	—	—
--------------------	--	-------	--------	---	---	---	---	---	---

### MERCEDES BENZ — Clase M (SUV)

1998-05	Clase M (SUV) — Todos	37219	—	—	—	—	—	—	—
---------	-----------------------	-------	---	---	---	---	---	---	---

### MERCEDES BENZ — Clase SLK

1999-04	SLK230 Kompressor (R170) — Coupé y Roadster	39044	39045■	—	—	—	—	—	—
1997-04	SLK230, SLK320 (R170) — Coupé, Convertible y Roadster	39044	39045■	—	—	—	—	—	—

### MERCEDES BENZ — Van Sprinter

2017	2500 — 4WD	—	—	—	66457	—	—	—	—
2010-18	(3/4 Ton) 2500 — RWD	—	—	553003 902135●	66450	—	—	—	—
2017-18	(1 Ton) 3500 — 4WD	—	—	—	66453	—	—	—	—
2010-18	(1 Ton) 3500 — RWD	—	—	553003 902135●	66414	—	—	—	—
		—	—	—	63620	—	—	—	—

### MERCURY — Capri y Capri II

1979-86	Capri y Capri II — Todos	71828 <sup>[1]</sup> <sup>[8]</sup>	5847	901925	—	—	—	—	—
---------	--------------------------	-------------------------------------	------	--------	---	---	---	---	---

### MERCURY — Cougar

1999-02	Cougar — Todos	71687	71984	902953	—	—	—	—	—
1992-97	Cougar Todos — Exc. Susp. Auto Ajustable	—	5965	901970	—	—	33134	—	—
		—	—	63621	—	—	—	—	—
1989-91	Cougar Todos — Exc. XR7	—	—	901970	—	—	—	—	—
		—	—	63621	—	—	—	—	—
1987-88	Cougar Todos — Inc. XR7	71828 <sup>[1]</sup> <sup>[8]</sup>	5861	—	—	—	—	—	—
		—	—	63620	—	—	—	—	—
1983-86	Cougar Todos — Inc. XR7	71716 <sup>[1]</sup> <sup>[8]</sup>	5861	—	—	—	—	—	—
		—	—	63621	—	—	—	—	—

### MERCURY — Grand Marquis

1983-91	Grand Marquis — Todos	5801	5803	—	—	32066	—	—	—
---------	-----------------------	------	------	---	---	-------	---	---	---

### MERCURY — Mariner

2008-11	Mariner — Todos								
	Derecho	71593	37318	904938	—	—	33200●	—	—
	Izquierdo	71594	37318	904938	—	—	33200●	—	—
2005-07	Mariner — Todos								
	Derecho	71593	37217	904938	—	—	—	—	—
	Izquierdo	71594	37217	904938	—	—	—	—	—

### MERCURY — Mystique

Feb 1995-97	Mystique — Todos c/ Motor 4 Cilindros	—	71984	902953	—	—	—	—	—
	Mystique — Todos c/ Motor 6 Cilindros	—	—	902953	—	—	—	—	—

● Nuevo número de parte

■ Número de parte bajo pedido especial

[1] Puede que se requiera el juego de piezas AK27 para reemplazar los tornillos y las tuercas originales del montaje inferior si están dañados o si no es posible reutilizarlos.

[8] El compresor de resorte NO ES necesario para reemplazar los struts en este vehículo.



## APLICACIONES

		GAS-MAGNUM® BASES DE AMORTIGUADOR CUBREPOLVO		MONRO-MATIC PLUS® MONRO-MATIC® HIDRÁULICO		ROADMATIC LOAD ADJUSTING® MAX-AIR®	

### MERCURY — Sable

1996-06	Sable — Sedán	71615 <sup>[1]</sup>	—	—	—	—	—	—	—
	Sable — Station Wagon	71615 <sup>[1]</sup>	5971	—	—	—	—	—	—
Mar 1994-95	Sable — Sedán	—	—	—	—	—	—	—	—
	Sable — Station Wagon	—	—	—	—	—	—	—	—

### MERCURY — Topaz

Mar 1985-94	Todos — FWD	—	—	—	—	—	—	—	—
----------------	-------------	---	---	---	---	---	---	---	---

### MERCURY — Villager

1999-02	Todos	—	37098	—	—	—	—	—	—
1993-98	Derecho	71900	37098	—	—	—	—	—	—
	Izquierdo	71901	37098	—	—	—	—	—	—

### MERCURY — Zephyr

1978-83	Todos	71828 <sup>[1]</sup>	5847	—	—	—	—	—	—
---------	-------	----------------------	------	---	---	---	---	---	---

### MINI — Cooper

2009-16	Hatchback y Convertible — Exc. Electronic Suspension, John Cooper Works y Hatchback Base c/ 1.5L	Derecho	72480	72482	—	—	—	—	—
		Izquierdo	72481	72482	—	—	—	—	—
2012-15	Coupe Exc. Paq. Sport	Derecho	72480	72482	—	—	—	—	—
		Izquierdo	72481	72482	—	—	—	—	—
2007-08	Hatchback Exc. John Cooper Works	Derecho	72480	72482	—	—	—	—	—
		Izquierdo	72481	72482	—	—	—	—	—
	Convertible	Derecho	72265	71112	—	—	—	—	—
		Izquierdo	—	71112	—	—	—	—	—
2002-06	Cooper — Todos	Derecho	72265	71112	—	—	—	—	—
		Izquierdo	—	71112	—	—	—	—	—

### MITSUBISHI — Eclipse

2011-12	Todos	—	—	—	—	—	—	—	—
2006-10	Todos — c/ Motor 4 Cil.	—	—	—	—	—	—	—	—
	Todos — c/ Motor 6 Cil.	—	—	—	—	—	—	—	—

[1] Puede que se requiera el juego de piezas AK27 para reemplazar los tornillos y las tuercas originales del montaje inferior si están dañados o si no es posible reutilizarlos.

[8] El compresor de resorte NO ES necesario para reemplazar los struts en este vehículo.

[54] Puede que se requiera el juego de piezas AK68 para reemplazar los tornillos y las tuercas originales del montaje inferior si están dañados o si no es posible reutilizarlos.

[108] Solo utilice con Struts Monroe



## APLICACIONES

			<b>GAS-MAGNUM®</b> BASES DE AMORTIGUADOR CUBREPOLVO		<b>MONRO-MATIC PLUS®</b> MONRO-MATIC® HIDRÁULICO		<b>ROADMATIC</b> LOAD ADJUSTING MAX-AIR®	

### MITSUBISHI — Eclipse (Cont.)

2000-05	Coupé y Convertible								
	Derecho	72147	71276 <sup>EL</sup>	904957	902923	—	—	—	—
	Izquierdo	72148	71276 <sup>EL</sup>	904957	902923	—	—	—	—
	Plato de Montura	—	—	—	909947	—	—	—	—
	Aislador de Resorte Superior	—	—	—	909969■	—	—	—	—
				63631	63628				

### MITSUBISHI — Galant

2009-11	Modelos ES y SE								
	Derecho	72347	—	908944	902923	—	—	—	—
	Izquierdo	—	—	908944	902923	—	—	—	—
	Plato	—	—	—	902059●	—	—	—	—
2004-08	Modelos DE, ES y SE								
	Derecho	72347	—	908944	902923	—	—	—	—
	Izquierdo	—	—	908944	902923	—	—	—	—
	Plato	—	—	—	902059●	—	—	—	—
2004-06	Modelo LS								
	Derecho	—	—	908944	902923	—	—	—	—
	Izquierdo	—	—	908944	902923	—	—	—	—
1999-03	Sedán								
	Derecho	—	71313	904957	902923	—	—	—	—
	Izquierdo	—	71313	904957	902923	—	—	—	—
	Plato de Montura	—	—	—	909947	—	—	—	—
	Aislador de Resorte Superior	—	—	—	909969■	—	—	—	—
				63631	63636				

### MITSUBISHI — Lancer

2017	Modelos SE, ES y SEL								
	Derecho	72504	72399	—	—	—	—	—	—
	Izquierdo	—	72399	—	—	—	—	—	—
2012-16	Modelos SE, ES y DE								
	Derecho	72504	72399	—	—	—	—	—	—
	Izquierdo	—	72399	—	—	—	—	—	—
2011	Modelos DE y ES								
	Derecho	72355	—	908912	905945	—	—	—	—
	Izquierdo	72356	—	908912	905945	—	—	—	—
					63628				
2008-11	Modelo GTS								
	Derecho	72504	72508	908912	905945	—	—	—	—
	Izquierdo	—	72508	908912	905945	—	—	—	—
					63628				
2008-10	Modelos DE y ES								
	Derecho	72355	72399	908912	905945	—	—	—	—
	Izquierdo	72356	72399	908912	905945	—	—	—	—
					63628				
2006-07	Sedán — Exc. Evolution								
	Aislador de Resorte Superior	72142	71379 <sup>EL</sup>	905944	905945	—	—	—	—
	Aislador de Resorte Inferior	—	—	902071■	—	—	—	—	—
		—	—	907964■	—	—	—	—	—
				63631	63628				

● Nuevo número de parte

■ Número de parte bajo pedido especial

<sup>EL</sup> Unidad Premium que son considerados con vástago de extensión lenta.





## APLICACIONES

		GAS-MAGNUM®		MONRO-MATIC PLUS®		ROADMATIC	
		BASES DE AMORTIGUADOR CUBREPOLVO		MONRO-MATIC® HIDRÁULICO		LOAD ADJUSTING® MAX-AIR®	

### MITSUBISHI — Lancer (Cont.)

2002-05	Todos — Exc. ES y Evolution	72142	71379 <sup>EL</sup>	905944	905945	—	—	—	—
	Aislador de Resorte Superior	—	—	902071 ■	—	—	—	—	—
	Aislador de Resorte Inferior	—	—	907964 ■	—	—	—	—	—
				63631	63628				
	ES	—	71379 <sup>EL</sup>	905943	905945	—	—	—	—

### MITSUBISHI — Montero

2001-03	Todos — Exc. c/ Susp. Electrónica	71357	37250	—	—	—	—	—	—
2000-04	Sport — Todos	37225	37226	—	—	32388R	32389R	—	—
1992-00	Todos — Exc. c/ Susp. Electrónica	—	—	—	—	32273	32274	—	—

### MITSUBISHI — Mirage

2014-17	Todos	—	5558●	—	—	—	—	—	—
---------	-------	---	-------	---	---	---	---	---	---

### MITSUBISHI — Outlander

2008-13	Outlander — Todos — Exc. Sport, c/ 3 filas de asientos								
	Derecho	72437	37310	908912	905945	—	—	—	—
	Izquierdo	72438	37310	908912	905945	—	—	—	—
				63638	63628				
2007	Outlander — Todos								
	Derecho	72437	37310	908912	905945	—	—	—	—
	Izquierdo	72438	37310	908912	905945	—	—	—	—
				63638	63628				
2005-06	Outlander — Todos	72418	71147	905944	905945	—	—	—	—
	Aislador de Resorte Inferior	—	—	907964 ■	—	—	—	—	—
				63638	63628				
2003-04	Outlander — Todos	72418	—	905944	905945	—	—	—	—
	Aislador de Resorte Superior	—	—	902071 ■	—	—	—	—	—
	Aislador de Resorte Inferior	—	—	907964 ■	—	—	—	—	—
				63638	63628				

### NISSAN — 350 Z

2003-05	Todos	—	5795	905985	—	—	—	—	—
				63628					

### NISSAN — 300ZX

1990-96	Coupé y Convertible — Exc. c/ Susp. Ajustable	—	—	905985	902978	—	—	—	—
---------	---	---	---	--------	--------	---	---	---	---

### NISSAN — Almera

2001-06	Todos — 3 y 5 Puertas Inc. Almera Sport								
	Derecho	71030	71032	—	—	—	—	—	—
	Izquierdo	71031	71032	—	—	—	—	—	—

### NISSAN — Altima

2013-18	Sedán								
	Derecho	72901	5637	902022	904985	—	33196	—	—
	Izquierdo	72902	5637	902022	904985	—	33196	—	—
				63631					

● Nuevo número de parte

■ Número de parte bajo pedido especial

R Monro-Matic Plus Reforzado

EL Unidad Premium que son considerados con vástago de extensión lenta.



## APLICACIONES

### NISSAN — Altima (Cont.)

2013	Coupe								
	Derecho	72392	5637	908913	904985	—	33196	—	—
	Izquierdo	72393	5637	908913	904985	—	33196	—	—
				63631					
2007-12	Todos — Exc. Híbrido y SR								
	Derecho	72392	5637	908913	904985	—	33196	—	—
	Izquierdo	72393	5637	908913	904985	—	33196	—	—
				63631					
2002-06	Todos								
	Derecho	71426	5990	906914	904985	801426	32410	400426	250410
	Izquierdo	71427	5990	906914	904985	801427	32410	400427	250410
				63633					
2000-01	Sedán								
	Derecho	71674	71676	—	902981	—	—	—	—
	Izquierdo	71675	71677	—	902981	—	—	—	—
				63619	63620				
1993-99	Sedán								
	Derecho	—	71943	—	902981	—	—	—	—
	Izquierdo	—	71944	—	902981	—	—	—	—
				63619	63620				

### NISSAN — Aprio

2007-10	Todos	72601	5660	902127●	—	—	—	—	—
---------	-------	-------	------	---------	---	---	---	---	---

### NISSAN — Armada

2017-22	Todos	73048●	—	907932	—	—	—	—	—
2005-15	Todos — Exc. c/ Sist. Trasero de Autonivelación	71358	37253	—	—	—	33223●	—	—
	Plato de Montura Superior	—	—	907932	—	—	—	—	—
	Aislador de Resorte Superior	—	—	907933	—	—	—	—	—
	Todos — c/ Sist. Trasero de Autonivelación	71358	—	—	—	—	—	—	—
	Plato de Montura Superior	—	—	907932	—	—	—	—	—
	Aislador de Resorte Superior	—	—	907933	—	—	—	—	—

### NISSAN — Cube

2009-14	Todos								
	Derecho	—	5658■	908917	—	—	—	—	—
	Izquierdo	72738	5658■	908916	—	—	—	—	—

### NISSAN — Datsun

1979-84	160J — Sedán y Guayín	—	—	—	—	—	1000	—	—
				63620					
1964-69	410, 411 Blue Bird — Sedán y Wagon	5840	5818	—	—	32132	—	250132	—
1974-77	710 — Sedán y Hardtop	—	5803	—	—	—	33049	—	—
				63620					
1969-74	Sedán y Guayín	—	5818	—	—	—	—	—	—
				63620					

● Nuevo número de parte

■ Número de parte bajo pedido especial



## APLICACIONES

		GAS-MAGNUM®		MONRO-MATIC PLUS®		ROADMATIC	
		BASES DE AMORTIGUADOR CUBREPOLVO		MONRO-MATIC® HIDRÁULICO		LOAD ADJUSTING® MAX-AIR®	

### NISSAN — Frontier Pickup

2009-19	Todos — Exc. Desert Runner y Pro-4x	71102	37273	—	—	—	—	—	—
	Plato de Montura Superior	—	—	🔧907928	—	—	—	—	—
	Aislador de Resorte Superior	—	—	🔧907929	—	—	—	—	—
2005-08	Todos — Exc. NISMO	71102	37273	—	—	—	—	—	—
	Plato de Montura Superior	—	—	🔧907928	—	—	—	—	—
	Aislador de Resorte Superior	—	—	🔧907929	—	—	—	—	—
2003-04	2WD — c/ Desert Runner	37245	911530	—	—	33182	—	—	—
1998-04	2WD — Crew Cab Exc. Desert Runner	37047	37029	—	—	32206	31094	250016●	250014●
1998-02	2WD — Exc. Crew Cab y Desert Runner	37077	37078	—	—	32113	31000	—	250001●
2004	4WD — Crew Cab	37245	911530	—	—	33182	—	—	—
2003-04	4WD — Exc. Crew Cab	37245	911530	—	—	33182	—	—	—
2000-03	4WD — Crew Cab	37047	37073	—	—	32206	31000	250016●	250001●
	Monotubo para Alto Desempeño	—	911530	—	—	—	—	—	—
1998-02	4WD — Exc. Crew Cab	37047	37073	—	—	32206	31000	250016●	250001●
	Monotubo para Alto Desempeño	—	911530	—	—	—	—	—	—

### NISSAN — Juke

2016-17	AWD — Exc. NISMO	—	37336	—	—	—	—	—	—
2011-15	AWD — Exc. NISMO	—	37336	—	—	—	—	—	—
	Aislador de Resorte Inferior	—	—	902023■	—	—	—	—	—
2011-16	FWD — Exc. NISMO	—	37352	—	—	—	—	—	—

### NISSAN — Kicks

2017-20	Todos	71059	5509	—	—	—	—	—	—
	Derecho	71060	5509	—	—	—	—	—	—
	Izquierdo	71060	5509	—	—	—	—	—	—

### NISSAN — Lucino

1995-99	Todos	71968	71278	🔧902938	🔧902978	801968	—	—	—
	Derecho	71969	71278	🔧902938	🔧902978	801969	—	—	—
	Izquierdo	71969	71278	🔧902938	🔧902978	801969	—	—	—
				🔧63619					

### NISSAN — March

2012-20	Todos	71059	5509	—	—	—	—	—	—
	Derecho	71060	5509	—	—	—	—	—	—
	Izquierdo	71060	5509	—	—	—	—	—	—

### NISSAN — Maxima

2021-22	Todos — Exc. SR	—	5552●	🔧63631	🔧904985	—	—	—	—
2016-20	Todos — Exc. SR	—	5552●	🔧902022	🔧904985	—	—	—	—
				🔧63631					
2019-22	SR	—	5552●	🔧63631	🔧904985	—	—	—	—
2016-18	SR	—	5552●	🔧902022	🔧904985	—	—	—	—
				🔧63631					

● Nuevo número de parte

■ Número de parte bajo pedido especial



## APLICACIONES

	<b>OESpectrum</b> <i>Reflex</i>		<b>GAS-MAGNUM®</b> BASES DE AMORTIGUADOR CUBREPOLVO		<b>MONRO-MATIC PLUS®</b> MONRO-MATIC® HIDRÁULICO		<b>ROADMATIC</b> LOAD ADJUSTING® MAX-AIR®	

### NISSAN — Maxima (Cont.)

2009-14	Todos								
	Derecho	72604	5659	908913	904985	—	—	—	—
	Izquierdo	72605	5659	908913 63631	904985	—	—	—	—
2004-08	Sedán								
	Derecho	72240	5600	906914	904985	802240■	33224●	—	—
	Izquierdo	72241	5600	906914 63619	904985	802241■	33224●	—	—
2002-03	Sedán								
	Derecho	71461	71327	906914	—	—	—	—	—
	Izquierdo	71462	71327	906914 63631	63629	—	—	—	—
2000-01	Sedán								
	Derecho	—	71327	906914	—	—	—	—	—
	Izquierdo	71419	71327	906914 63631	63628	—	—	—	—
1995-99	Sedán								
	Derecho	71682	71293 <sup>EL</sup>	—	903911■	—	—	—	—
	Izquierdo	71683	71293 <sup>EL</sup>	—	903911■	—	—	—	—
				63622	63628				
1989-94	Sedán								
		—	—	902989 <sup>56</sup>	—	—	—	—	—
				63620	63619				

### NISSAN — Micra

2004-08	Todos								
	Derecho	71063	—	—	—	—	—	—	—

### NISSAN — Murano

2014-22	Todos								
	Derecho	72936	37317	—	—	—	33204●	—	—
	Izquierdo	72937	37317	—	—	—	33204●	—	—
				63631					
2011-13	Todos								
	Derecho	72955	37317	—	—	—	33204●	—	—
	Izquierdo	72956	37317	—	—	—	33204●	—	—
	Plato de Montura	—	—	908998	—	—	—	—	—
				63631					
2009-10	Todos								
	Derecho	—	37317	—	—	—	33204●	—	—
	Izquierdo	72607	37317	—	—	—	33204●	—	—
	Plato de Montura	—	—	908998	—	—	—	—	—
				63631					
2003-08	Todos								
	Derecho	72267	37282	906914	—	802267	33217●	—	—
	Izquierdo	—	37282	906914	—	802268	33217●	—	—
				63631					

### NISSAN — Note

2014-19	Todos								
	Derecho	71059	5673	—	—	—	—	—	—
	Izquierdo	71060	5673	—	—	—	—	—	—

● Nuevo número de parte

■ Número de parte bajo pedido especial

<sup>EL</sup> Unidad Premium que son considerados con vástago de extensión lenta.

<sup>56</sup> El balero 901947 está disponible cuando se necesite reemplazar el balero solamente.



## APLICACIONES

				BASES DE AMORTIGUADOR CUBREPOLVO		MONRO-MATIC® HIDRÁULICO		LOAD ADJUSTING MAX-AIR®	

### NISSAN — NP300

2015-20	Todos	71102	—	—	—	—	—	—	—
2009-14	4x2	37047	—	—	—	—	—	—	—

### NISSAN — NP300 Frontier

2016-20	Todos	71102	—	—	—	—	—	—	—
---------	-------	-------	---	---	---	---	---	---	---

### NISSAN — NV200

2013-20	Todos — Exc. Taxi								
	Derecho	72668	37334	⊕63631	—	—	—	—	—
	Izquierdo	72669	37334	⊕63631	—	—	—	—	—
	Todos — Taxi	—	37334	⊕63631	—	—	—	—	—

### NISSAN — Pathfinder

2013-19	Todos								
	Derecho	72936	37363	⊕63631	—	—	—	—	—
	Izquierdo	72937	37363	⊕63631	—	—	—	—	—
2005-12	Todos	71103	37274	—	—	—	—	—	—
	Plato de Montura Superior	—	—	⊕907928	—	—	—	—	—
	Aislador de Resorte Superior	—	—	⊕907929	—	—	—	—	—
2004	Todos — Exc. Armada	—	37204	⊕903954	—	—	33215●	—	—
				⊕63633					
2002-03	Todos	—	37204	⊕903954	—	—	33215●	—	—
				⊕63633					
Dic 1998-01	Todos								
	Derecho	71573	37204	⊕903954	—	—	33215●	—	—
	Izquierdo	—	37204	⊕903954	—	—	33215●	—	—
1996- Nov 98	Todos								
	Derecho	—	37158	⊕903954	—	—	—	—	—
	Izquierdo	71571	37158	⊕903954	—	—	—	—	—
1987-95	Todos	37100	37029	—	—	—	—	—	—

### NISSAN — Pickup

1998-09	Todos	—	—	34968	34803	—	31000	—	250001●
1995-97	2WD	37077	37078	—	—	32113	31000	—	250001●
	4WD	37047	37073	—	—	32206	31000	250016●	250001●
	Para Remolque	—	—	—	—	—	—	—	MA812■
1984-94	Todos	—	—	—	—	1408	1409	—	—

### NISSAN — Pickup D-21

1965-94	2WD — Inc. Chassis, Estacas y Doble Cabina	37077	37078	34968	34803	32113	31000 1412	—	250001●
	4WD — Inc. Chassis, Estacas y Doble Cabina	37047	37073	—	—	1408	1409	—	—

### NISSAN — Pickup 720

1983-86	2WD — Inc. King Cab	—	—	—	—	32206	31162	250016●	—
1983- Jun 86	4WD	—	—	—	—	32206	31094	250016●	250014●

### NISSAN — Platina

2002-10	Todos	—	—	906912	—	801017	31197	400017	250197
---------	-------	---	---	--------	---	--------	-------	--------	--------

### NISSAN — Quest (Mini Van)

2011-17	Todos	—	37357	—	—	—	—	—	—
---------	-------	---	-------	---	---	---	---	---	---

● Nuevo número de parte

■ Número de parte bajo pedido especial

## APLICACIONES

	<b>OESpectrum</b>	<b>GAS-MAGNUM®</b>	<b>MONRO-MATIC PLUS®</b>	<b>ROADMATIC</b>
	<b>Reflex</b>	BASES DE AMORTIGUADOR CUBREPOLVO	MONRO-MATIC® HIDRÁULICO	LOAD ADJUSTING® MAX-AIR®

### NISSAN — Quest (Mini Van) (Cont.)

2004-09	Todos								
	Derecho	72271	37283	906914	—	—	—	—	—
	Izquierdo	72272	37283	906914	—	—	—	—	—
1999-03	Todos								
	Derecho	—	37098	902989 <sup>56</sup>	—	—	—	—	—
	Izquierdo	—	37098	902989 <sup>56</sup>	—	—	—	—	—
				63619					
1993-98	Todos								
	Derecho	71900 <sup>58</sup>	37098	902989 <sup>56</sup>	—	—	—	—	—
	Izquierdo	71901 <sup>58</sup>	37098	902989 <sup>56</sup>	—	—	—	—	—
				63619					

### NISSAN — Rogue

2015-20	Todos								
	Derecho	73074●	37328	63630	—	—	—	—	—
	Izquierdo	73075●	37328	63630	—	—	—	—	—
Feb 2012-14	Todos								
	Derecho	—	37328	908916	—	—	—	—	—
	Izquierdo	—	37328	908917	—	—	—	—	—
	Aislador Delantero Inferior	—	—	902023■	—	—	—	—	—
2008- Feb 12	Todos								
	Derecho	72608	37328	908915	—	—	—	—	—
	Izquierdo	72609	37328	908914	—	—	—	—	—
	Aislador Delantero Inferior	—	—	902023■	—	—	—	—	—
				63640					

### NISSAN — Sentra

2014-19	Todos — Exc. SR Turbo y Nismo								
	Derecho	72947	5532	902060●	—	—	—	—	—
	Izquierdo	72948	5532	902061●	—	—	—	—	—
				63631					
2013	Todos								
	Derecho	72947	5525	902060●	—	—	—	—	—
	Izquierdo	72948	5525	902061●	—	—	—	—	—
				63631					
2007-12	Todos — Exc. SE-R y Spec V								
	Derecho	72378	5639	908915	—	—	33205●	400008●	250009
	Izquierdo	72379	5639	908914	—	—	33205●	400009●	250009
	Aislador de Resorte Inferior	—	—	909925	—	—	—	—	—
				63631					
2002-06	Sedán (B15) — Exc. SE-R y SE-R Spec V								
	Derecho	72105	71312 <sup>EL</sup>	903950 <sup>130</sup>	—	802105	—	400105	400312
	Izquierdo	72106	71312 <sup>EL</sup>	903950 <sup>130</sup>	—	802106	—	400106	400312
				63631	63628				

● Nuevo número de parte

■ Número de parte bajo pedido especial

EL Unidad Premium que son considerados con vástago de extensión lenta.

<sup>56</sup> El balero 901947 está disponible cuando se necesite reemplazar el balero solamente.

<sup>58</sup> Puede que se requiera el juego de piezas AK58 para reemplazar los tornillos y las tuercas originales del montaje inferior si están dañados o si no es posible reutilizarlos o si NO SON de diseño Cam.

<sup>130</sup> Excluye el uso con un brazo de soporte para torre de strut



## APLICACIONES

### NISSAN — Sentra (Cont.)

2002-06 (Cont.)	Sedán (B15) SE-R y SE-R Spec V								
	Derecho	72107	71359		—	—	—	—	—
	Izquierdo	72108	71359		—	—	—	—	—
2000-01	Sedán (B15)								
	Derecho	71566	71312 <sup>EL</sup>		—	801566	—	—	400312
	Izquierdo	71567	71312 <sup>EL</sup>		—	801567	—	—	400312
1996-99	Sedán y Coupé (B14)								
	Derecho	71968 <sup>58</sup>	71278			801968	—	—	—
	Izquierdo	71969 <sup>58</sup>	71278			801969	—	—	—

### NISSAN — Stanza

1987-89	Sedán y Hatchback	—	—	—	—	—	—	—	—
1984-86	Sedán y Hatchback	—	—	—	—	—	—	—	—

### NISSAN — Tiida

2012-18	Todos — c/ Motor de 1.8L								
	Derecho	72351	5626		—	—	33203●	—	—
	Izquierdo	72352	5626		—	—	33203●	—	—
2007-11	Todos								
	Derecho	72351	5626		—	—	33203●	—	—
	Izquierdo	72352	5626		—	—	33203●	—	—

### NISSAN — Titan Pickup

2017-22	Todos — Exp. Paquete Off-Road y Pro 4X	71358	—	—	—	—	—	—	—
	Plato de Montura Superior	—	—		—	—	—	—	—
	Aislador de Resorte Superior	—	—		—	—	—	—	—
2004-15	2WD	71358	37252	—	—	—	33225●	—	—
	Plato de Montura Superior	—	—		—	—	—	—	—
	Aislador de Resorte Superior	—	—		—	—	—	—	—
	4WD — Exp. Pro 4X	71358	37251	—	—	—	33218●	—	—
	Plato de Montura Superior	—	—		—	—	—	—	—
	Aislador de Resorte Superior	—	—		—	—	—	—	—

### NISSAN — Tsubame

1993-04	Todos								
	Derecho	—	—		—	MW871	1000	400871	—
	Izquierdo	—	—		—	MW872	1000	400872	—

● Nuevo número de parte

EL Unidad Premium que son considerados con vástago de extensión lenta.

<sup>58</sup> Puede que se requiera el juego de piezas AK58 para reemplazar los tornillos y las tuercas originales del montaje inferior si están dañados o si no es posible reutilizarlos o si NO SON de diseño Cam.

<sup>130</sup> Excluye el uso con un brazo de soporte para torre de strut



## APLICACIONES

	<b>OESpectrum</b>	<b>GAS-MAGNUM®</b>		<b>MONRO-MATIC PLUS®</b>		<b>ROADMATIC</b>	
	<b>Reflex</b>	BASES DE AMORTIGUADOR CUBREPOLVO		MONRO-MATIC® HIDRÁULICO		LOAD ADJUSTING MAX-AIR®	

### NISSAN — Tsuru

1992-17	Tsuru III — Todos								
	Derecho	—	—	902938	901989	MW871	MW873	400871	400873
	Izquierdo	—	—	902938	901989	MW872	MW874	400872	400874
				63619	63620				
1988-91	Tsuru II — Sedán y Guayín								
	Derecho	—	—	—	—	MW815	MW817	—	—
	Izquierdo	—	—	—	—	MW815	MW816	—	—
				63619	63619				
1984-87	Tsuru I — Todos								
	Derecho	—	—	—	—	—	3116	—	—
	Izquierdo	—	—	—	—	—	3116	—	—
				63619					

### NISSAN — Urvan

2000-13	Todos	37321	37320	—	—	—	—	—	—
---------	-------	-------	-------	---	---	---	---	---	---

### NISSAN — Van Urvan

1998-03	Todos	—	—	—	—	—	31000 1412	—	250001 ●
---------	-------	---	---	---	---	---	---------------	---	----------

### NISSAN — Van Ichi Van

1987-94	Todos	—	—	34754	34904	—	—	—	—
---------	-------	---	---	-------	-------	---	---	---	---

### NISSAN — Van Vanette Panel

1987-94	Todos	—	—	34754	34904	—	—	—	—
---------	-------	---	---	-------	-------	---	---	---	---

### NISSAN — Versa

2022	Todos — Exc. SR								
	Derecho	71059	5673	902138 ●	—	—	—	—	—
	Izquierdo	71060	5673	902138 ●	—	—	—	—	—
	SR	—	5673	902138 ●	—	—	—	—	—
2014-21	Todos								
	Derecho	71059	5673	902138 ●	—	—	—	—	—
	Izquierdo	71060	5673	902138 ●	—	—	—	—	—
2012-13	Todos — c/ Motor 1.6L								
	Derecho	71059	5673	902138 ●	—	—	—	—	—
	Izquierdo	71060	5673	902138 ●	—	—	—	—	—

### NISSAN — Xterra

2011-15	4WD — Todos Exc. PRO-4X	71103	37276	—	—	—	33222 ●	—	—
	Plato de Montura Superior	—	—	907928	—	—	—	—	—
	Aislador de Resorte Superior	—	—	907929	—	—	—	—	—
2007-15	2WD — Todos	71103	37275	—	—	—	—	—	—
	Plato de Montura Superior	—	—	907928	—	—	—	—	—
	Aislador de Resorte Superior	—	—	907929	—	—	—	—	—
2005-10	4WD — Todos Exc. Off-Road	71103	37276	—	—	—	33222 ●	—	—
	Plato de Montura Superior	—	—	907928	—	—	—	—	—
	Aislador de Resorte Superior	—	—	907929	—	—	—	—	—
2005-06	2WD — Todos Exc. Off-Road	71103	37275	—	—	—	—	—	—
	Plato de Montura Superior	—	—	907928	—	—	—	—	—
	Aislador de Resorte Superior	—	—	907929	—	—	—	—	—
2002-04	Todos	37245	37172	—	—	33182	33181	—	—
2000-01	Todos	37171	37172	—	—	33180	33181	—	—

● Nuevo número de parte





## APLICACIONES

				BASES DE AMORTIGUADOR CUBREPOLVO		MONRO-MATIC HIDRÁULICO		LOAD ADJUSTING MAX-AIR	

### NISSAN — X-Trail

2015-20	Todos	—	37328	—	—	—	—	—	—
2008-14	Segunda Generación								
	Derecho	72997	37370	—	—	—	—	—	—
	Izquierdo	72998	37370	—	—	—	—	—	—
2001-07	Primera Generación								
	Derecho	72317	72319	—	—	—	—	—	—
	Izquierdo	72318	72320	—	—	—	—	—	—

### OLDSMOBILE — Calais

1985-91	Todos	—	5896	—	901951	—	—	—	—
	Derecho	—	5896	—	901951	—	—	—	—
	Izquierdo	—	5896	63622	—	—	—	—	—

### OLDSMOBILE — Cutlass Ciera

1985-96	Todos	—	5897	901934 63622	901951	—	33108	—	—
1982-84	Todos — Exc. c/ Suspensión HD	—	5897	901934 63622	901951	—	—	—	—

### OLDSMOBILE — Cutlass

1968-88	Todos	5840	5802	—	—	32132	—	250132	—
---------	-------	------	------	---	---	-------	---	--------	---

### OLDSMOBILE — Cutlass Supreme

1988-97	FWD	—	—	901921	—	—	—	—	—
1978-87	Todos	5840	5802	—	—	32132	—	250132	—

### OLDSMOBILE — Eighty-Eight (88)

1991-99	Todos — Exc. c/ Sist. de Autonivelable de Aire Trasero	—	—	—	901953 63622	—	—	—	—
	Todos — c/ Sist. de Autonivelable de Aire Trasero	—	—	—	901953 63622	—	—	—	—
1987-89	Sedán — c/ Susp. de Lujo Exc. c/ Sistema Autonivelable de Aire Trasero	—	—	—	901953 63622	—	—	—	—

### OLDSMOBILE — Eurosport

1985-90	Todos	—	5897	901934 63622	901951	—	33108	—	—
---------	-------	---	------	-----------------	--------	---	-------	---	---

### OLDSMOBILE — Intrigue

1998-02	Todos	—	71671	902973®	902969	—	—	—	—
	Derecho	—	71671	902973®	902968	—	—	—	—
	Izquierdo	—	71671	902973® 63622	902968	—	—	—	—

### OLDSMOBILE — Omega

1980-84	Todos	—	5897 <sup>(46)</sup>	—	—	—	33108	—	—
---------	-------	---	----------------------	---	---	---	-------	---	---

® Este número de pieza es una marca registrada de Tenneco y no se puede usar ni reproducir sin permiso.

(46) Se requiere el juego de piezas AK79 para instalar un PAR de estas unidades en esta aplicación.

## APLICACIONES

	<b>OESpectrum</b>	<b>GAS-MAGNUM®</b>		<b>MONRO-MATIC PLUS®</b>		<b>ROADMATIC</b>	
	<b>Reflex</b>	BASES DE AMORTIGUADOR CUBREPOLVO		MONRO-MATIC® HIDRÁULICO		LOAD ADJUSTING® MAX-AIR®	

### OLDSMOBILE — Silhouette

1997-05	Todos — Exc. c/ Sist. de Autonivelación y AWD Aislador de Resorte Inferior	71661	37156	902973* 904943■ 63622	—	801661	32333	—	—
1990-96	Todos Inc. AWD — Exc. c/ Sist. de Autonivelación	—	—	901934 63622	901951	—	—	—	—

### PEUGEOT — 206

1999-09	Todos	—	—	—	—	MW016	1195	—	—
---------	-------	---	---	---	---	-------	------	---	---

### PEUGEOT — 207

2006-14	Todos	72999	5534	—	—	—	—	—	—
---------	-------	-------	------	---	---	---	---	---	---

### PEUGEOT — 306

1997-03	Todos — Exc. Station Wagon	—	—	902125●	—	—	—	—	—
	Station Wagon	—	—	902125●	—	—	—	—	—

### PEUGEOT — 307

2003-10	Hatchback								
	Derecho	73000	—	—	—	—	—	—	—
	Izquierdo	73001	—	—	—	—	—	—	—

### PEUGEOT — Partner

2003-09	Todos	71042	5606	—	—	—	—	—	—
---------	-------	-------	------	---	---	---	---	---	---

### PLYMOUTH — Acclaim

1989-95	Acclaim — Todos	72589②	5962	901908 904916 63621	—	—	33095	—	—
	Asiento y Aislador de Resorte Superior	—	—	—	—	—	—	—	—

### PLYMOUTH — Barracuda

1970-74	Barracuda — Todos	—	—	—	—	32022	32073	—	—
1964-69	Barracuda — Todos	—	—	—	—	32022	31131	—	—

### PLYMOUTH — Caravelle

1977-89	Caravelle RWD — Todos	5829	5837	—	—	—	—	—	—
Ene	Caravelle FWD — Todos	—	—	901908	—	—	33095	—	—
1986-88	Asiento y Aislador de Resorte Superior	—	—	904916 63622	—	—	—	—	—
1984- Dic 85	Caravelle FWD — Todos	—	—	— 63622	—	—	33095	—	—

### PLYMOUTH — Duster

1960-76	Duster — Todos	—	—	—	—	32022	31131	—	—
---------	----------------	---	---	---	---	-------	-------	---	---

### PLYMOUTH — Reliant

Ene	Reliant — Todos	—	—	901908	—	—	33095	—	—
1986-89	Asiento y Aislador de Resorte Superior	—	—	904916 63622	—	—	—	—	—
1984-85	Reliant — Todos	—	—	— 63622	—	—	33095	—	—

- Nuevo número de parte
- Número de parte bajo pedido especial
- Ⓜ Este número de pieza es una marca registrada de Tenneco y no se puede usar ni reproducir sin permiso.

② Puede que se requiera el juego de piezas AK37 para reemplazar los tornillos y las tuercas originales del montaje inferior si están dañados o si no es posible reutilizarlos.



## APLICACIONES

		GAS-MAGNUM® BASES DE AMORTIGUADOR CUBREPOLVO		MONRO-MATIC PLUS® MONRO-MATIC® HIDRÁULICO		ROADMATIC LOAD ADJUSTING® MAX-AIR®	

### PLYMOUTH — Reliant (Cont.)

1981-83	Reliant — Todos	—	—	—	—	—	33095	—	—
---------	-----------------	---	---	---	---	---	-------	---	---

### PLYMOUTH — Roadrunner

1973-75	Roadrunner — Todos	—	—	—	—	32134■	32073	—	—
---------	--------------------	---	---	---	---	--------	-------	---	---

### PLYMOUTH — Sundance

1989-94	Sundance — Todos	72589Ⓜ	5962	901908	—	—	33095	—	—
	Asiento y Aislador de Resorte Superior	—	—	904916	—	—	—	—	—
				63621					
1987-88	Sundance — Todos	—	5962	901908	—	—	33095	—	—
	Asiento y Aislador de Resorte Superior	—	—	904916	—	—	—	—	—
				63622					

### PLYMOUTH — Volare

1976-80	Volare — Todos	5829	5837	—	—	31176	—	—	—
---------	----------------	------	------	---	---	-------	---	---	---

### PONTIAC — Aztek AWD

2001-05	Aztek AWD — Todos	—	39052	902973®	—	—	—	—	—
	Aislador de Resorte Inferior	—	—	904943■	—	—	—	—	—
				63622					
	Aztek FWD — Todos	—	37156	902973®	—	—	32333	—	—
	Aislador de Resorte Inferior Para Remolque	—	—	904943■	—	—	—	—	—
				63622					MA824 <sup>106</sup>

### PONTIAC — Bonneville

1991-99	Todos — Exc. c/ Sist. Autonivelable de Aire	—	—	—	901953	—	—	—	—
				63622	63622				
	Todos — c/ Sist. Autonivelable de Aire	—	—	—	901953	—	—	—	—
				63622					

### PONTIAC — Firebird

1993-02	Firebird Inc. Trans Am — Todos	72362	5867	—	—	—	—	—	—
	Derecho	72362	5867	—	—	—	—	—	—
	Izquierdo	—	—	904962■	—	—	—	—	—
	Asiento de Resorte Inferior	—	—	—	—	—	—	—	—

### PONTIAC — G3

2006-09	G3 — Todos	72295	5794	905906	905981	—	—	400295	250794
	Derecho	72296	5794	905906	905981	—	—	400296	250794
	Izquierdo	—	—	—	—	—	—	—	—

### PONTIAC — G5

2007-09	G5 — Todos	72179	5779	905907	—	—	—	—	—
				63619					

### PONTIAC — G6

2005-10	G6 — Todos	72199	5778	905908	—	802199	—	400019●	—
	Derecho	72200	5778	905909	—	802200	—	400020●	—
	Izquierdo	—	—	63619					

● Nuevo número de parte

■ Número de parte bajo pedido especial

Ⓜ Este número de pieza es una marca registrada de Tenneco y no se puede usar ni reproducir sin permiso.

Ⓜ Puede que se requiera el juego de piezas AK37 para reemplazar los tornillos y las tuercas originales del montaje inferior si están dañados o si no es posible reutilizarlos.

106 El kit del adaptador AK-29 se requiere para instalar esta unidad al adaptar amortiguadores de choque ajustables del aire a los vehículos sin sistema de nivelación posterior.

## APLICACIONES

	<b>OESpectrum</b>	<b>GAS-MAGNUM®</b>	<b>MONRO-MATIC PLUS®</b>		<b>ROADMATIC</b>			
	<b>Reflex</b>	<b>BASES DE AMORTIGUADOR</b> <b>CUBREPOLVO</b>	<b>MONRO-MATIC® HIDRÁULICO</b>		<b>LOAD ADJUSTING</b> <b>MAX-AIR®</b>			

### PONTIAC — Grand Am

1999-05	Grand Am — Todos	—	71686	—	—	—	—	—	—
				⌀63622	⌀63619				
1996-98	Grand Am — Todos	—	5970	⊠904912 <sup>Ⓡ</sup>	⊠901951	—	—	—	—
				⌀63621					
1992-94	Grand Am — Todos	—	5896	—	⊠901951	—	—	—	—
				⌀63621					
1985-91	Grand Am — Todos	—	5896	—	⊠901951	—	—	—	—
				⌀63622					

### PONTIAC — Grand Prix

1997-03	Grand Prix — Todos	71661	71662	⊠902973 <sup>®</sup>	⊠902969	801661	801662	—	—
	Aislador de Resorte Inferior	—	—	—	904941 ■	—	—	—	—
				⌀63622					
1988-96	Grand Prix FWD — Todos	—	—	⊠901921	—	—	—	—	—
1973-87	Grand Prix — Todos	5840	5802	—	—	32132	—	250132	—

### PONTIAC — GTO

2004-06	GTO — Todos	—	5786 ■	⊠903932	—	—	—	—	—
---------	-------------	---	--------	---------	---	---	---	---	---

### PONTIAC — Le Mans

1973-83	Le Mans — Todos	5840	5802	—	—	32132	—	250132	—
---------	-----------------	------	------	---	---	-------	---	--------	---

### PONTIAC — Matiz

2006-10	Matiz — Todos								
	Derecho	72602	5661	—	—	—	—	400002	250003
	Izquierdo	72603	5661	—	—	—	—	400003	250003
2004-05	Matiz — Todos								
	Derecho	72520	5652	—	—	—	—	—	—
	Izquierdo	72521	5652	—	—	—	—	—	—

### PONTIAC — Sunfire

1995-05	Sunfire Todos — Exc. Segundo Diseño de 1999	—	71281	⊠904912 <sup>Ⓡ</sup>	⊠902949 <sup>®</sup>	—	801281	—	—
	Aislador de Resorte Inferior	—	—	904940 ■	—	—	—	—	—
				⌀63619					

### PONTIAC — Torrent

2007-09	Torrent — Todos — Exc. c/ Suspensión Deportiva								
	Derecho	72526	911258	⊠906956	—	—	—	400026	250012 ●
	Izquierdo	72527	911258	⊠906956	—	—	—	400027	250012 ●
2006	Torrent — Todos								
	Derecho	72209	911258	⊠905980	—	—	—	—	250012 ●
	Izquierdo	72210	911258	⊠905980	—	—	—	—	250012 ●

### PONTIAC — Vibe

2009-10	Vibe — AWD								
	Derecho	72597	72600	⊠908942	⊠904990	—	—	—	—
	Izquierdo	72598	72600	⊠908942	⊠904990	—	—	—	—
				⌀63630					
	Vibe — FWD	—	72599	⊠908942	—	—	—	—	—
				⌀63630					

● Nuevo número de parte

■ Número de parte bajo pedido especial

Ⓡ Este número de pieza es una marca registrada de Tenneco y no se puede usar ni reproducir sin permiso.

Ⓡ El balero 901928 está disponible cuando se necesite reemplazar el balero solamente.



## APLICACIONES

### PONTIAC — Vibe (Cont.)

2003-08	Vibe — AWD								
	Derecho	—	—	904935	904990	802116	—	—	—
	Izquierdo	72117	—	904935	904990	—	—	—	—
	Aislador de Resorte Inferior	—	—	906936 ■	—	—	—	—	—
				63630					
	Vibe — FWD								
	Derecho	—	71373	904935	904990	802116	—	—	—
	Izquierdo	72117	71373	904935	904990	—	—	—	—
	Aislador de Resorte Inferior	—	—	906936 ■	—	—	—	—	—
				63630					

### RAM — 700

2015-20	700 — Todos	71040	—	—	—	—	—	—	—
---------	-------------	-------	---	---	---	---	---	---	---

### RAM — Serie 1500

2019-22	Classic — 2WD Exc. Susp. De Aire	911300	911299	34800	34795 550060	—	—	—	—
	Para Remolque	—	—	—	—	—	—	—	MA837
2011-18	2WD — Todos Exc. Tradesman HD	911300	911299	34800	34795 550060	—	—	—	—
	Para Remolque	—	—	—	—	—	—	—	MA837
2019	Classic — 4WD Exc. Susp. De Aire	72292	911299	907930	34795 550060	—	—	—	—
	Asiento de Resorte Superior	—	—	907931	—	—	—	—	—
	Kit de bujes del brazo de control inferior	—	—	908962	—	—	—	—	—
	Para Remolque	—	—	—	—	—	—	—	MA837
2011-18	4WD — Todos Exc. Susp. De Aire	72292	911299	907930	34795 550060	—	—	—	—
	Asiento de Resorte Superior	—	—	907931	—	—	—	—	—
	Kit de bujes del brazo de control inferior	—	—	908962	—	—	—	—	—
	Para Remolque	—	—	—	—	—	—	—	MA837

### RAM — Serie 2500

2010-13	2WD	911221	911222	34520	34521	—	—	—	—
---------	-----	--------	--------	-------	-------	---	---	---	---

### RAM — Serie 2500 Amortiguador de Dirección

		Sin Soporte	Con Soporte
2014-19	2500 2WD - Unidad de Reemplazo para OEM 68232449AB, AC	SC2973	—
	2500 4WD - Unidad de Reemplazo para OEM 68232449AA, AB, AC	SC2973	—
	3500 2WD - Unidad de Reemplazo para OEM 68232449AB, AC	SC2973	—
2013-19	3500 4WD - Unidad de Reemplazo para OEM 68232449AA, AB, AC	SC2973	—
2011-17	4500 y 5500 (Reemplaza # OEM 52855623AC,AD)	SC2966	—

### RAM — Serie Promaster

2014-22	1500 — Todos	—	—	553007	—	—	—	—	—
	Para Remolque	—	—	—	—	—	—	—	58655
					66449				
2014-19	2500 — Todos	—	—	553007	—	—	—	—	—
					66440				
	3500 — Todos	—	—	553007	—	—	—	—	—
					66440				

■ Número de parte bajo pedido especial



## APLICACIONES

		<b>GAS-MAGNUM®</b> BASES DE AMORTIGUADOR CUBREPOLVO		<b>MONRO-MATIC PLUS®</b> MONRO-MATIC® HIDRÁULICO		<b>ROADMATIC</b> LOAD ADJUSTING MAX-AIR®			

### RAM — Serie Promaster (Cont.)

2015-19	City — Todos								
	Derecho	72985	37362	—	—	—	—	—	—
	Izquierdo	72986	37362	—	—	—	—	—	—

### RENAULT — Captur

2018-20	Todos								
	Derecho	73005	73006	902127●	—	—	—	—	—
	Izquierdo	73004	73006	902127●	—	—	—	—	—

### RENAULT — Clio

2001-10	Todos — Exc. Sport	—	—	906912	—	801017	31197	400017	250197
---------	--------------------	---	---	--------	---	--------	-------	--------	--------

### RENAULT — Duster

2019	2WD								
	Derecho	73005	—	902127●	—	—	—	—	—
	Izquierdo	73004	—	902127●	—	—	—	—	—
2012-18	2WD								
	Derecho	73005	37371	902127●	—	—	—	—	—
	Izquierdo	73004	37371	902127●	—	—	—	—	—
2012-19	4WD								
	Derecho	73005	73006	902127●	—	—	—	—	—
	Izquierdo	73004	73006	902127●	—	—	—	—	—

### RENAULT — Kangoo

2007-09	Todos	71039	5792	906912 ●63619	—	—	—	—	—
---------	-------	-------	------	------------------	---	---	---	---	---

### RENAULT — Kangoo Express

2013-18	Todos	71053	—	—	—	—	—	—	—
2004-12	Todos	71039	5792	906912 ●63619	—	—	—	—	—

### RENAULT — Koleos

2017-20	Todos	—	37328	—	—	—	—	—	—
2009-16	Todos								
	Derecho	72997	—	—	—	—	—	—	—
	Izquierdo	72998	—	—	—	—	—	—	—

### RENAULT — Laguna

2003-06	Todos	71038	39114	—	—	—	—	—	—
---------	-------	-------	-------	---	---	---	---	---	---

### RENAULT — Logan

2015-18	Todos	72601	—	902127●	—	—	—	—	—
---------	-------	-------	---	---------	---	---	---	---	---

### RENAULT — Megane, Megane II

2004-10	Todos	72645	—	902126●	—	—	—	—	—
---------	-------	-------	---	---------	---	---	---	---	---

### RENAULT — Oroch

2019-20	Todos								
	Derecho	73005	73006	902127●	—	—	—	—	—
	Izquierdo	73004	73006	902127●	—	—	—	—	—

### RENAULT — Sandero

2010-18	Dynamique y Expression	72601	5660	—	—	—	—	—	—
---------	------------------------	-------	------	---	---	---	---	---	---

● Nuevo número de parte



## APLICACIONES

		GAS-MAGNUM®		MONRO-MATIC PLUS®		ROADMATIC	
		BASES DE AMORTIGUADOR CUBREPOLVO		MONRO-MATIC® HIDRÁULICO		LOAD ADJUSTING® MAX-AIR®	

### RENAULT — Scala

2011-13	Todos								
	Derecho	72107	71312 <sup>EL</sup>	—	—	—	—	—	400312
	Izquierdo	72108	71312 <sup>EL</sup>	—	—	—	—	—	400312

### RENAULT — Stepway

2015-20	Todos	—	—	902127●	—	—	—	—	—
2012-14	Todos	—	5660	902127●	—	—	—	—	—
2010-11	Todos	72601	5660	902127●	—	—	—	—	—

### RENAULT — Scenic

2001-04	Todos	—	—	—	—	—	—	—	—
---------	-------	---	---	---	---	---	---	---	---

### SAAB — 9-2x

2005-06	Todos								
	Derecho	—	—	902924	905950	—	—	—	—
	Izquierdo	—	—	902924	905950	—	—	—	—

### SAAB — 9-3

2009-11	Todos — Exc. AWD	—	5618	906985	—	—	—	—	—
2003-08	Todos — Exc. AWD								
	Derecho	72327	5618	906985	—	—	—	—	—
	Izquierdo	72328	5618	906985	—	—	—	—	—

### SAAB — 9-5

2002-06	Todos	72178	5992	903959	—	—	—	—	—
1999-01	Todos	—	5992	903959	—	—	—	—	—

### SATURN — Ion

2007	Todos	—	5668	63632	—	—	33207●	—	—
2003-06	Todos — Exc. Modelos Red Line	—	5668	63632	—	—	33207●	—	—

### SEAT — Alhambra

2002-08	Todos	71033	5781	902906	—	—	—	—	—
2010-12									
2005-06									

### SEAT — Cordoba

2003-09	Todos	71029	5791	906905	904910	—	—	400029	250791
1999-02	Todos	—	—	902905	904910	MW009	MW013	—	—

### SEAT — Ibiza

2010-17	Todos	71058	5507	—	—	—	—	—	—
2003-09	Todos	71029	5791	906905	904910	—	—	400029	250791
2001-02	Todos	—	—	902905	904910	MW009	MW013	—	—

### SEAT — León

2006-13	Todos								
	c/ Montura inferior de 50 mm	73007	5984	—	—	—	—	—	250984
	c/ Montura inferior de 55 mm	73008	5984	—	—	—	—	—	250984
2001-08	Todos — Exc. c/ barra estabilizadora	71525	5984	904905	904910	—	—	400525	250984

### SEAT — Nuevo Ibiza

2001-02	Todos	71058	5507	—	—	—	—	—	—
---------	-------	-------	------	---	---	---	---	---	---

● Nuevo número de parte

EL Unidad Premium que son considerados con vástago de extensión lenta.



## APLICACIONES

	<b>OESpectrum</b>	<b>GAS-MAGNUM®</b>		<b>MONRO-MATIC PLUS®</b>		<b>ROADMATIC</b>	
	<b>Reflex</b>	BASES DE AMORTIGUADOR		MONRO-MATIC® HIDRÁULICO		LOAD ADJUSTING®	
		CUBREPOLVO				MAX-AIR®	

### SEAT — Toledo

2013-19	Todos	71058	5507	—	—	—	—	—	—
2001-08	Todos	71525	5984	904905	904910	—	—	400525	250984

### SCION — tC

2011-16	Todos								
	Derecho	72682■	5684■	—	—	—	—	—	—
	Izquierdo	72683■	5684■	—	—	—	—	—	—
	Aislador Superior	—	—	909931■	—	—	—	—	—
				63638■					
2005-10	Todos								
	Derecho	72390■	72400■	907943■	904990	—	—	—	—
	Izquierdo	72391■	72400■	907943■	904990	—	—	—	—
	Asiento de Resorte Superior	—	—	909962■	—	—	—	—	—
				63630					

### SCION — xB

2008-15	Todos								
	Derecho	72670■	5687■	906988	—	—	—	—	—
	Izquierdo	72671■	5687■	906988	—	—	—	—	—
				63638■					

### SCION — xD

2011-14	Todos								
	Derecho	—	5675■	906989	—	—	—	—	—
	Izquierdo	—	5675■	906989	—	—	—	—	—
				63638■					
2008-10	Todos								
	Derecho	—	5624	906989	—	—	—	—	—
	Izquierdo	—	5624	906989	—	—	—	—	—
				63638■					

### SUBARU — B9 Tribeca

2006-07	Todos								
	Asiento de Resorte Superior	—	—	902006■	—	—	—	—	—

### SUBARU — Crosstrek

2016-17	Todos								
	Derecho	73070●	—	908926	—	—	—	—	—
	Izquierdo	73071●	—	908926	—	—	—	—	—
				63640					

### SUBARU — Forester

2018	Todos								
	Derecho	73068●	—	908926	—	—	—	—	—
	Izquierdo	73069●	—	908926	—	—	—	—	—
	Aislador de Resorte Superior	—	—	902008■	—	—	—	—	—
	Asiento de Resorte Superior	—	—	902007■	—	—	—	—	—
				63640					
2014-17	Todos								
	Derecho	73068●	73084●	908926	—	—	—	—	—
	Izquierdo	73069●	73084●	908926	—	—	—	—	—
	Aislador de Resorte Superior	—	—	902008■	—	—	—	—	—
	Asiento de Resorte Superior	—	—	902007■	—	—	—	—	—
				63640					

● Nuevo número de parte

■ Número de parte bajo pedido especial





## APLICACIONES

				 BASES DE AMORTIGUADOR CUBREPOLVO		 MONRO-MATIC® HIDRÁULICO		 LOAD ADJUSTING MAX-AIR®	

### SUBARU — Forester (Cont.)

2009-13	Todos								
	Derecho	72678 ■	72695	908926 ■	902066 ●	—	—	—	—
	Izquierdo	72679 ■	72695	908926 ■	902066 ●	—	—	—	—
	Aislador de Resorte Superior	—	—	902008 ■	—	—	—	—	—
	Asiento de Resorte Superior	—	—	902007 ■	—	—	—	—	—
				63631					
2006-08	Todos — Exc. c/Susp. Autonivelable								
	Derecho	72425	72445 ■	902924 ■	905950	—	—	—	—
	Izquierdo	72426	72446 ■	902924 ■	905950	—	—	—	—
	Aislador de Resorte Superior	—	—	902008 ■	—	—	—	—	—
	Asiento de Resorte Superior	—	—	902007 ■	—	—	—	—	—
				63631	63630				

### SUBARU — Impreza

2015	Todos — Exc. Modelo WRX								
	Derecho	72960 ■	72696 ■	908926 ■	—	—	—	—	—
	Izquierdo	72961 ■	72696 ■	908926 ■	—	—	—	—	—
				63631	63630				
2012-14	Base	—	72696 ■	908926 ■	902066 ●	—	—	—	—
				63631	63630				
	Todos — Exc. Modelo WRX y Base								
	Derecho	72960 ■	72696 ■	908926 ■	902066 ●	—	—	—	—
	Izquierdo	72961 ■	72696 ■	908926 ■	902066 ●	—	—	—	—
				63631	63630				
2008-11	Todos — Exc. Modelo WRX Sti								
	Derecho	72680 ■	72696 ■	908926 ■	902066 ●	—	—	—	—
	Izquierdo	72681 ■	72696 ■	908926 ■	902066 ●	—	—	—	—
				63631	63630				
2004-07	Sedán — Submodelos WRX, WRX Limited y WRX TR								
	Aislador de Resorte Superior	—	—	902008 ■	—	—	—	—	—
	Asiento de Resorte Superior	—	—	902007 ■	—	—	—	—	—
				63631	63630				
2005-07	Wagon — Submodelos 2.5i, Outback Sport y RS								
	Aislador de Resorte Superior	—	—	902008 ■	—	—	—	—	—
	Asiento de Resorte Superior	—	—	902007 ■	—	—	—	—	—
				63631	63630				
2004-07	Wagon — Submodelos WRX & WRX Limited								
	Aislador de Resorte Superior	—	—	902008 ■	—	—	—	—	—
	Asiento de Resorte Superior	—	—	902007 ■	—	—	—	—	—
				63631	63630				
2004	Wagon — Submodelos Outback & TS								
	Aislador de Resorte Superior	—	—	902008 ■	—	—	—	—	—
	Asiento de Resorte Superior	—	—	902007 ■	—	—	—	—	—
				63631	63630				

● Nuevo número de parte

■ Número de parte bajo pedido especial



## APLICACIONES

	<b>OESpectrum</b> <i>Reflex</i>		<b>GAS-MAGNUM®</b> BASES DE AMORTIGUADOR CUBREPOLVO		<b>MONRO-MATIC PLUS®</b> MONRO-MATIC® HIDRÁULICO		<b>ROADMATIC</b> LOAD ADJUSTING® MAX-AIR®	

### SUBARU — Impreza (Cont.)

2002-03	Sedán — Submodelos RS y WRX								
	Derecho	—	—	902924 ■	903986 ■	—	—	—	—
	Izquierdo	—	—	902924 ■	903987 ■	—	—	—	—
	Aislador de Resorte Superior	—	—	902008 ■	—	—	—	—	—
	Aislador de Resorte Inferior	—	—	—	906936 ■	—	—	—	—
	Asiento de Resorte Superior	—	—	902007 ■	—	—	—	—	—
				63631	63630				
	Wagon — Submodelos Outback, TS y WRX								
	Derecho	—	—	902924 ■	903986 ■	—	—	—	—
	Izquierdo	—	—	902924 ■	903987 ■	—	—	—	—
	Aislador de Resorte Superior	—	—	902008 ■	—	—	—	—	—
	Asiento de Resorte Superior	—	—	902007 ■	—	—	—	—	—
				63631					

### SUBARU — Legacy

2013-14	Todos								
	Derecho	73079 ●	—	902924 ■	—	—	—	—	—
	Izquierdo	73080 ●	—	902924 ■	—	—	—	—	—
				63631					
2010-12	Todos								
	Derecho	72684 ■	72690 ■	902924 ■	—	—	—	—	—
	Izquierdo	72685 ■	72690 ■	902924 ■	—	—	—	—	—
				63631					
2005-09	Todos — c/Frenos ABS								
	Derecho	—	72690 ■	908926 ■	—	—	—	—	—
	Izquierdo	—	72501 ■	908926 ■	—	—	—	—	—
				63631					
2000-04	Todos — c/ Frenos ABS								
	Asiento de Resorte Superior	—	71354 ■	902924 ■	904934 ■	—	—	—	—
				902006 ■	—	—	—	—	—
				63619					

### SUBARU — Outback

2013-14	Todos								
	Derecho	73040 ■	73039 ■	902924 ■	—	—	—	—	—
	Izquierdo	73041 ■	73039 ■	902924 ■	—	—	—	—	—
	Asiento de Resorte Superior	—	—	902006 ■	—	—	—	—	—
				63640					
2010-12	Todos								
	Derecho	72686 ■	72691 ■	902924 ■	—	—	—	—	—
	Izquierdo	72687 ■	72691 ■	902924 ■	—	—	—	—	—
	Asiento de Resorte Superior	—	—	902006 ■	—	—	—	—	—
				63631					
2005-09	Todos								
	Derecho	—	72567 ■	908926 ■	904934 ■	—	—	—	—
	Izquierdo	—	72567 ■	908926 ■	904934 ■	—	—	—	—
				63631					

### SUBARU — Tribeca

2008-14	Todos								
	Asiento de Resorte Superior	—	—	902006 ■	—	—	—	—	—
				63640					

● Nuevo número de parte

■ Número de parte bajo pedido especial



## APLICACIONES

### SUBARU — XV Crosstrek

2013-15	Todos								
	Derecho	73070●	73085●	908926	—	—	—	—	—
	Izquierdo	73071●	73085●	908926	—	—	—	—	—
	Aislador de Resorte Superior	—	—	902008■	—	—	—	—	—
	Asiento de Resorte Superior	—	—	902007■	—	—	—	—	—
				63640					

### SUZUKI — Aerio

2004-07	Todos								
	Derecho	72469	72465	905951	—	—	—	—	—
	Izquierdo	72468	—	905951	—	—	—	—	—
				63631					
2002-03	Todos — Exc. SX								
	Derecho	—	72465	905951	—	—	—	—	—
	Izquierdo	—	—	905951	—	—	—	—	—
				63631					

### SUZUKI — Grand Vitara

2006-17	2WD y 4WD — Todos								
	Derecho	72423	37308	—	—	—	—	—	—
	Izquierdo	72424	37308	—	—	—	—	—	—

### SUZUKI — Swift

2012-17	Todos								
	Derecho	73009	5536	—	—	—	—	—	—
	Izquierdo	73010	5536	—	—	—	—	—	—

### SUZUKI — SX4

2007-14	Todos	—	5688	—	—	—	—	—	—
---------	-------	---	------	---	---	---	---	---	---

### TOYOTA — 4 Runner

2003-22	Todos — Exc. c/ Sist. de Susp. X—REAS	71371	37270	—	—	801371	—	—	—
	Plato de Montura	—	—	907922	—	—	—	—	—
2003-09	Todos — c/ Susp. De Aire Trasera — Kit de conversión	—	90022C■	—	—	—	—	—	—
1996-02	Todos — c/ Motor 4 Cilindros	71352	37157	904900	—	—	32334	—	—
	Todos — c/ Motor 6 Cilindros	71351	37157	904900	—	—	32334	—	—
1990-95	Todos	37030	37033	—	—	—	—	—	—
1986-89	Todos	37030	37032	—	—	—	—	—	—
1984-85	Todos	37031	37032	—	—	—	—	—	—

### TOYOTA — 4 Runner Amortiguador de Dirección

1986-96	Todos — Reemplaza #45700-35050,-51 y 45700-39046						Sin Soporte	Con Soporte	
							SC2947	—	

### TOYOTA — Avalon

2019-22	Todos FWD, XLE, Hybrid XLE	—	5555●	—	—	—	—	—	—
---------	----------------------------	---	-------	---	---	---	---	---	---

● Nuevo número de parte

■ Número de parte bajo pedido especial

## APLICACIONES

	OESpectrum <i>Reflex</i>		GAS-MAGNUM® BASES DE AMORTIGUADOR CUBREPOLVO		MONRO-MATIC PLUS® MONRO-MATIC® HIDRÁULICO		ROADMATIC LOAD ADJUSTING® MAX-AIR®	

### TOYOTA — Avalon (Cont.)

2013-15	Todos	—	—	—	902024■	—	—	—	—
	Aislador de Resorte Inferior Derecho	—	—	902025■	—	—	—	—	—
	Aislador de Resorte Inferior Izquierdo	—	—	902026■	—	—	—	—	—
	Aislador de Resorte Inferior Derecho	—	—	—	902027■	—	—	—	—
	Aislador de Resorte Inferior Izquierdo	—	—	—	902028■	—	—	—	—
				⌘63630					
2008-12	Todos	—	—	—	—	—	—	—	—
	Derecho	72307	72309	⌘906986	⌘908966	—	—	—	—
	Izquierdo	72308	72310	⌘906986	⌘908965	—	—	—	—
				⌘63630					
Ene 2006-07	Todos	—	—	—	—	—	—	—	—
	Derecho	72307	—	⌘906986	⌘908966	—	—	—	—
	Izquierdo	72308	—	⌘906986	⌘908965	—	—	—	—
				⌘63630					
Ene 2005- Ene 06	Sedán	—	—	—	—	—	—	—	—
	Derecho	72739	72207	—	⌘908965	—	802207	—	—
	Izquierdo	72740	72208	—	⌘908966	—	802208	—	—
				⌘63630					
2004- Ene 05	Todos	—	—	—	—	—	—	—	—
	Derecho	—	—	⌘903906	⌘903904	—	—	—	—
	Izquierdo	—	—	⌘903903	⌘903904	—	—	—	—
				⌘63619	⌘63619				
1995-96	Sedán	—	—	—	—	—	—	—	—
	Derecho	—	71680	—	—	—	—	—	—
	Izquierdo	—	71681	—	—	—	—	—	—
	Aislador de Resorte Inferior	—	—	—	904953■	—	—	—	—
				⌘63619	⌘63619				

### TOYOTA — Camry

2020-22	Todos — Exc. AWD	—	5555●	—	—	—	—	—	—
2018-19	Todos	—	5555●	—	—	—	—	—	—
2012-17	LE, XLE, Híbrido LE, Híbrido XLE	—	—	—	—	—	—	—	—
	Derecho	72940	72942	⌘906986	902024■	—	—	—	—
	Izquierdo	72941	72943	⌘906986	902024■	—	—	—	—
				⌘63630	⌘63632				
	Modelos SE, Edición Especial, XSE, SE Híbrido	—	—	—	—	—	—	—	—
	Derecho	72992	73033	⌘906986	902024■	—	—	—	—
	Izquierdo	72993	73034	⌘906986	902024■	—	—	—	—
				⌘63630	⌘63632				
2007-11	Todos — Exc. Modelo SE	—	—	—	—	—	—	—	—
	Derecho	72307	72309	⌘906986	⌘908965	—	—	—	—
	Izquierdo	72308	72310	⌘906986	⌘908966	—	—	—	—
				⌘63630					

● Nuevo número de parte

■ Número de parte bajo pedido especial



## APLICACIONES

				 BASES DE AMORTIGUADOR CUBREPOLVO		 MONRO-MATIC® HIDRÁULICO		 LOAD ADJUSTING MAX-AIR®	

### TOYOTA — Camry (Cont.)

2007-11 (Cont.)	Modelo SE								
	Derecho	72307	72384	906986	908965	—	—	—	—
	Izquierdo	72308	72385	906986 63630	908966	—	—	—	—
2004-06	Sedán								
	Derecho	72205	72207	904989	903904	—	802207	—	—
	Izquierdo	—	72208	904989 63619	903904 63619	—	802208	—	—
2002-03	Sedán								
	Derecho	—	—	904989	903904	—	—	—	—
	Izquierdo	—	71493	904989	903904	—	—	—	—
	Aislador de Resorte Inferior	—	—	—	904953■	—	—	—	—
				63619	63619				
1997-01	Sedán, Coupé y Convertible								
	Derecho	71678	71680	903903	903904	801678	—	—	—
	Izquierdo	—	71681	903906	903904	—	—	—	—
	Aislador de Resorte Inferior	—	—	—	904953■	—	—	—	—
				63619	63619				
1995-96	Sedán, Coupé y Wagon								
	Derecho	—	71680	—	—	801979	—	—	—
	Izquierdo	—	71681	—	—	—	—	—	—
	Aislador de Resorte Inferior	—	—	—	904953■	—	—	—	—
				63619	63619				
1992-94	Todos								
	Derecho	—	71680	902926	—	—	—	—	—
	Izquierdo	72283	71681	902926	—	—	—	—	—
	Aislador de Resorte Inferior	—	—	—	904953■	—	—	—	—
				63619	63619				

### TOYOTA — Corolla

2019	Sedán c/ Motor de 1.8L								
	Derecho	72989	72991	908942	904990	—	—	—	—
	Izquierdo	72990	72991	908942	904990	—	—	—	—
	Asiento de Resorte Superior	—	—	909955■	—	—	—	—	—
	Aislador de Resorte Inferior	—	—	909957 63640	—	—	—	—	—
2017-18	Todos								
	Derecho	72989	72991	908942	904990	—	—	—	—
	Izquierdo	72990	72991	908942	904990	—	—	—	—
	Asiento de Resorte Superior	—	—	909955■	—	—	—	—	—
	Aislador de Resorte Inferior	—	—	909957 63640	—	—	—	—	—
2014-16	Todos								
	Derecho	72989	72991	908942	904990	—	—	—	—
	Izquierdo	72990	72991	908942	904990	—	—	—	—
	Plato Derecho	—	—	—	902062●	—	—	—	—
	Plato Izquierdo	—	—	—	902063●	—	—	—	—
	Asiento de Resorte Superior	—	—	909955■	—	—	—	—	—
	Aislador de Resorte Inferior	—	—	909957 63640	—	—	—	—	

● Nuevo número de parte

■ Número de parte bajo pedido especial



## APLICACIONES

	OESpectrum <i>Reflex</i>		GAS-MAGNUM® BASES DE AMORTIGUADOR CUBREPOLVO		MONRO-MATIC PLUS® MONRO-MATIC® HIDRÁULICO		ROADMATIC LOAD ADJUSTING® MAX-AIR®	

### TOYOTA — Corolla (Cont.)

2009-13	Todos								
	Derecho	72597	72599	908942	904990	—	—	—	—
	Izquierdo	72598	72599	908942	904990	—	—	—	—
	Asiento de Resorte Superior	—	—	909955■	—	—	—	—	—
	Aislador de Resorte Superior	—	—	909956■	—	—	—	—	—
	Aislador de Resorte Inferior	—	—	909957	—	—	—	—	—
			63630	63628					
2003-08	Sedán								
	Derecho	72114	71373	905957	904990	—	—	—	—
	Izquierdo	72115	71373	905957	904990	—	—	—	—
	Aislador de Resorte Inferior	—	—	906936■	—	—	—	—	—
	Plato de Montura Derecho	—	—	—	908988	—	—	—	—
	Plato de Montura Izquierdo	—	—	—	—	—	—	—	—
	Aislador de Resorte Superior	—	—	909956■	—	—	—	—	—
	Asiento de Resorte Superior	—	—	909962■	—	—	—	—	—
			63640	63628					
1993-02	Sedán y Station Wagon								
	Derecho	71951	71953	905912	902901	—	—	—	—
	Izquierdo	71952	71954	905912	902901	—	—	—	—
			63620	63618					
1990-92	TS Coupé								
	Derecho	—	71846 <sup>[42]</sup>	905912	902901	—	—	—	—
	Izquierdo	—	71847 <sup>[42]</sup>	905912	902901	—	—	—	—
			63620	63618					
1988-92	Sedán FWD — Exc. All-Track (4WD)								
	Derecho	—	71846 <sup>[42]</sup>	905912	902901	—	—	—	—
	Izquierdo	—	71847 <sup>[42]</sup>	905912	902901	—	—	—	—
			63620	63618					

### TOYOTA — FJ Cruiser

2007-13	Todos	71371	37270	—	—	801371	—	—	—
	Plato de Montura Superior			907922					

### TOYOTA — Hiace

2006-18	Todos	37372	37373	—	—	—	—	—	—
---------	-------	-------	-------	---	---	---	---	---	---

### TOYOTA — Highlander

2014-19	Todos								
	Derecho	73088●	37361	—	—	—	—	—	—
	Izquierdo	73089●	37361	—	—	—	—	—	—
				63630					

● Nuevo número de parte

■ Número de parte bajo pedido especial

[42] Puede que se requiera el juego de piezas AK51 para reemplazar los tornillos y las tuercas originales del montaje inferior si están dañados o si no es posible reutilizarlos.



## APLICACIONES

				BASES DE AMORTIGUADOR CUBREPOLVO		MONRO-MATIC® HIDRÁULICO		LOAD ADJUSTING MAX-AIR®	

### TOYOTA — Highlander (Cont.)

Ago 2010-13	AWD								
	Derecho	72765	72489	906986	908920	—	—	—	—
	Izquierdo	72766	72490	906986	908921	—	—	—	—
	Asiento de Resorte Superior	—	—	909942	—	—	—	—	—
	Aislador de Resorte Inferior	—	—	—	904953	—	—	—	—
				63630	63640				
	FWD								
	Derecho	72765	72485	906986	908920	—	—	—	—
Izquierdo	72766	72486	906986	908921	—	—	—	—	
Asiento de Resorte Superior	—	—	909942	—	—	—	—	—	
Aislador de Resorte Inferior	—	—	—	904953	—	—	—	—	
			63630	63640					
2008-Ago 10	AWD								
	Derecho	72483	72489	906986	908920	—	—	—	—
	Izquierdo	—	72490	906986	908921	—	—	—	—
	Asiento de Resorte Superior	—	—	909942	—	—	—	—	—
	Aislador de Resorte Inferior	—	—	—	904953	—	—	—	—
				63630	63640				
	FWD								
	Derecho	72483	72485	906986	908920	—	—	—	—
Izquierdo	—	72486	906986	908921	—	—	—	—	
Asiento de Resorte Superior	—	—	909942	—	—	—	—	—	
Aislador de Resorte Inferior	—	—	—	904953	—	—	—	—	
			63630	63640					
2004-07	AWD — Hybrid, Hybrid Limited								
	Derecho	72211	72213	904989	—	802211	—	—	—
	Izquierdo	72212	72214	904989	—	802212	—	—	—
	Aislador de Resorte Superior	—	—	909943	—	—	—	—	—
				63630	63640				
	FWD								
	Derecho	72211	72213	904989	—	802211	—	—	—
	Izquierdo	72212	72214	904989	—	802212	—	—	—
Aislador de Resorte Superior	—	—	909943	—	—	—	—	—	
			63630	63640					

### TOYOTA — Hilux

2012-15	2WD y 4WD — c/ Amortiguador Delantero	—	5798	—	—	—	—	—	—
2004-11	2WD y 4WD — c/ Amortiguador Delantero	37030	5798	—	—	—	—	—	—
2004-15	2WD y 4WD — c/ Strut Delantero	71041	5798	—	—	—	—	—	—

### TOYOTA — Land Cruiser

2013-15	Todos	—	37342	—	—	—	—	—	—
2008-11	Todos	—	37342	—	—	—	—	—	—
Ene 1998-07	HJ95 — c/ Susp. Delantera de Barra de Torsión	37183	37184	—	—	—	—	—	—
1990-Ene 98	FJ80 — c/ Susp. Delantera de Resorte	—	—	34787	34788	—	—	—	—
1988-90	FJ60 — Station Wagon	—	—	34959	34828	—	—	—	—

■ Número de parte bajo pedido especial



## APLICACIONES

	<b>OESpectrum</b> <i>Reflex</i>	<b>GAS-MAGNUM®</b> BASES DE AMORTIGUADOR CUBREPOLVO	<b>MONRO-MATIC PLUS®</b> MONRO-MATIC® HIDRÁULICO	<b>ROADMATIC</b> LOAD ADJUSTING® MAX-AIR®

### TOYOTA — Land Cruiser Amortiguador de Dirección

		Sin Soporte	Con Soporte
1995-98	Todos — Reemplaza # OEM 4570060052)	SC2957 ■	—
1980-95	Todos — Reemplaza # OEM 4570060020, 4570060025, 4570043901	SC2946 ☒	—

### TOYOTA — Matrix

2009-13	2WD	Derecho	72597	—	☒908942	☒904990	—	—	—	—	
		Izquierdo	72598	—	☒908942	☒904990	—	—	—	—	
		Asiento de Resorte Superior	—	—	909955 ■ ☒63630	—	—	—	—	—	
	Wagon AWD	Derecho	72597	72600	—	☒904990	—	—	—	—	
		Izquierdo	72598	72600	—	☒904990	—	—	—	—	
		Asiento de Resorte Superior	—	—	909955 ■ ☒63630	—	—	—	—	—	
	Crossover 2WD	Derecho	72597	72599	—	☒904990	—	—	—	—	
		Izquierdo	72598	72599	—	☒904990	—	—	—	—	
		Aislador de Resorte Superior	—	—	☒908942	—	—	—	—	—	
	2003-08	Wagon 2WD	Derecho	—	71373	☒904935	☒904990	802116	—	—	—
			Izquierdo	72117	71373	☒904935	☒904990	—	—	—	—
			Aislador de Resorte Inferior	—	—	906936 ■ ☒63618	—	—	—	—	—
Wagon 4WD		Derecho	—	—	☒904935	☒904990	802116	—	—	—	
		Izquierdo	72117	—	☒904935	☒904990	—	—	—	—	
		Aislador de Resorte Inferior	—	—	906936 ■ ☒63618	—	—	—	—	—	

### TOYOTA — MR2 Spyder

2000-05	Todos	—	—	☒905957	—	—	—	—	—
---------	-------	---	---	---------	---	---	---	---	---

### TOYOTA — Pickup Compact

1985-93	2WD 1 Ton — Inc. c/ Doble Rodado Trasero	—	—	34953	34803	32383	—	—	—
1986-95	4WD — Todos	37030	37032	—	—	32245	—	—	—

### TOYOTA — Pickup Compact Amortiguador de Dirección

		Sin Soporte	Con Soporte
1986-95	4WD — Reemplaza # 4570035050,-51 y 4570039046	SC2947	—

### TOYOTA — Pickup T100

1993-98	2WD — Exc. Modelo de 1 Ton	37063	37073	—	—	—	—	—	—
	4WD — Todos	37030	37101	—	—	32245	32270	—	—

### TOYOTA — Pickup T100 Amortiguador de Dirección

		Sin Soporte	Con Soporte
1993-98	4WD — Reemplaza # OEM 4570034010	SC2954 ☒	—

■ Número de parte bajo pedido especial

☒ Juego de fuelle SA-19XX está disponible para el uso con nuestros cilindros de estabilizador de dirección.





## APLICACIONES

### TOYOTA — Previa (Van)

1990-97	2WD y 4WD — Todos	—	37074 ■	901944®	—	—	—	—	—
	Derecho	—	37074 ■	901944®	—	—	—	—	—
	Izquierdo	—	37074 ■	901944®	—	—	—	—	—
				63618					

### TOYOTA — Prius

2018	Todos	—	5544 ■	63631	—	—	—	—	—
2016-17	Todos	—	5544 ■	63631	—	—	—	—	—
	Derecho	72688 ■	5544 ■	63631	—	—	—	—	—
	Izquierdo	72689 ■	5544 ■	63631	—	—	—	—	—
2010-15	Todos	—	—	906987	—	—	33219 ●	—	—
	Derecho	72688 ■	5685	906987	—	—	33219 ●	—	—
	Izquierdo	72689 ■	5685	906987	—	—	33219 ●	—	—
	Aislador Superior	—	—	909931	—	—	—	—	—
				63638					
2004-09	Todos	—	—	905957	904990	—	—	—	—
	Derecho	—	—	905957	904990	—	—	—	—
	Izquierdo	72358	—	905957	904990	—	—	—	—
	Aislador de Resorte Superior	—	—	909956 ■	—	—	—	—	—
	Asiento de Resorte Superior	—	—	909962 ■	—	—	—	—	—
				63630					

### TOYOTA — Prius C

2016-19	Todos	—	5624	906989	—	—	—	—	—
				63630					
2012-15	Todos	—	5624	906989	—	—	—	—	—
	Derecho	72288	5624	906989	—	—	—	—	—
	Izquierdo	72289	5624	906989	—	—	—	—	—
				63630					

### TOYOTA — Prius V

2017	Todos	—	5502 ■	906989	—	—	—	—	—
				63638					
2012-16	Todos	—	5502 ■	906989	—	—	—	—	—
	Derecho	72682 ■	5502 ■	906989	—	—	—	—	—
	Izquierdo	72683 ■	5502 ■	906989	—	—	—	—	—
	Aislador Superior	—	—	909931	—	—	—	—	—
				63638					

### TOYOTA — RAV4

2013-18	Todos — Exc. Híbrido y EV	—	—	—	—	—	—	—	250019 ●
	Derecho	73013	37289	—	—	—	—	—	250019 ●
	Izquierdo	73014	37289	—	—	—	—	—	250019 ●
	Aislador Superior	—	—	909931	—	—	—	—	—
				63630					
2009-12	Todos	—	—	906987	—	802275	—	400015 ●	250019 ●
	Derecho	72275	37289	906987	—	802275	—	400015 ●	250019 ●
	Izquierdo	72276	37289	906987	—	—	—	400016 ●	250019 ●
	Aislador Superior	—	—	909931	—	—	—	—	—
				63630					

● Nuevo número de parte

■ Número de parte bajo pedido especial

® Este número de pieza es una marca registrada de Tenneco y no se puede usar ni reproducir sin permiso.



## APLICACIONES

	OESpectrum <i>Reflex</i>		GAS-MAGNUM® BASES DE AMORTIGUADOR CUBREPOLVO		MONRO-MATIC PLUS® MONRO-MATIC® HIDRÁULICO		ROADMATIC LOAD ADJUSTING® MAX-AIR®	

### TOYOTA — RAV4 (Cont.)

2006-08	Todos								
	Derecho	72275	37289	—	—	802275	—	400015●	250019●
	Izquierdo	72276	37289	—	—	—	—	400016●	250019●
	Base de Amortiguador Tipo A	—	—	‡906987 <sup>[215]</sup>	—	—	—	—	—
	Base de Amortiguador Tipo B	—	—	‡906988 <sup>[216]</sup>	—	—	—	—	—
			⌘63630						
	Sport								
	Aislador Superior	—	—	‡909931	—	—	—	—	—
Mayo 2000-05	Todos								
	Derecho	71453	37199	‡903995	—	—	—	—	—
	Izquierdo	71454	37199	‡903995	—	—	—	—	—
	Todos — Strut sellado con modelo base								
	Asiento de Resorte Superior	—	—	909939■	—	—	—	—	—
	Aislador de Resorte Superior	—	—	909940■	—	—	—	—	—
1996- Abril 00	Todos — c/ Struts sellados								
	Derecho	—	37199	‡903995	—	—	—	—	—
	Izquierdo	72127	37199	‡903995	—	—	—	—	—
				⌘63619					

### TOYOTA — Sequoia

2008-22	Todos — Exc. c/ Susp. Electrónica	71137	37324	—	—	—	—	—	—
	Plato de Montura Superior	—	—	‡907923	—	—	—	—	—
2001-07	Todos — Exc. c/ Sistema de Nivelación Automático	—	—	—	—	—	33212●	—	—

### TOYOTA — Sienna

2015-20	FWD — Exc. c/ Acceso a personas con movilidad reducida (Mobility Auto Access)								
	Derecho	73094●	37284	‡902033	—	—	—	—	—
	Izquierdo	73095●	37284	‡902033	—	—	—	—	—
				⌘63640					
	FWD — c/ Acceso a personas con movilidad reducida (Mobility Auto Access)								
	Derecho	73094●	37301	‡902033	—	—	—	—	—
	Izquierdo	73095●	37301	‡902033	—	—	—	—	
				⌘63640					
2011-14	AWD								
	Derecho	73092●	37301	‡902033	—	—	—	—	—
	Izquierdo	73093●	37301	‡902033	—	—	—	—	—
				⌘63640					
2011-14	FWD — Motor de 3.5L — c/ Acceso a personas con movilidad reducida (Mobility Auto Access )								
	Derecho	72781	37301	‡902033	—	—	—	—	—
	Izquierdo	72782	37301	‡902033	—	—	—	—	—
				⌘63640					

● Nuevo número de parte

■ Número de parte bajo pedido especial

[215] Base de amortiguador y Ensamblaje de balero/Asiento de Resorte (2 piezas)

[216] Ensamblaje de base de amortiguador/balero/asiento de resorte (1 pieza)



## APLICACIONES

	OESpectrum <i>Reflex</i>		GAS-MAGNUM® BASES DE AMORTIGUADOR CUBREPOLVO		MONRO-MATIC PLUS® MONRO-MATIC® HIDRÁULICO		ROADMATIC LOAD ADJUSTING® MAX-AIR®	

### TOYOTA — Sienna (Cont.)

2011-14 (Cont.)	FWD — Motor de 3.5L — Exc. Acceso personas con Movilidad Redicida (Mobility Auto Access)								
	Derecho	72781	37284	902033	—	—	—	—	—
	Izquierdo	72782	37284	902033 63640	—	—	—	—	—
	AWD								
	Derecho	73049	37301	902033	—	—	—	—	—
	Izquierdo	73050	37301	902033 63640	—	—	—	—	—
2011-12	FWD — Motor de 2.7L								
	Derecho	73049	37301	—	—	—	—	—	—
2007-10	(Mini Van) — AWD								
	Derecho	—	37301	904989	—	—	—	—	—
	Izquierdo	—	37301	904989 63630	—	—	—	—	—
	(Mini Van) — FWD Modelos de 8 Pasajeros								
	Derecho	—	37301	904989	—	—	—	—	—
	Izquierdo	—	37301	904989 63630	—	—	—	—	—
2004-06	(Mini Van) — FWD Modelos de 7 Pasajeros								
	Derecho	—	37284	904989	—	—	—	—	—
	Izquierdo	—	37284	904989 63630	—	—	—	—	—
	(Mini Van) — AWD								
	Derecho	—	37301	904989	—	—	—	—	—
	Izquierdo	—	37301	904989 63630	—	—	—	—	—
1998-03	(Mini Van) FWD — Modelos de 8 Pasajeros								
	Derecho	—	37301	904989	—	—	—	—	—
	Izquierdo	—	37301	904989 63630	—	—	—	—	—
	(Mini Van) FWD — Modelos de 7 Pasajeros								
Derecho	—	37284	904989	—	—	—	—	—	
Izquierdo	72237	37284	904989 63630	—	—	—	—	—	
1998-03	(Mini Van) — Todos								
	Derecho	—	37243	903903	—	—	33275	—	—
Izquierdo	—	37243	903906	—	—	33275	—	—	



## APLICACIONES

	<b>OESpectrum</b>	<b>GAS-MAGNUM®</b>		<b>MONRO-MATIC PLUS®</b>		<b>ROADMATIC</b>	
	<b>Reflex</b>	BASES DE AMORTIGUADOR CUBREPOLVO		MONRO-MATIC® HIDRÁULICO		LOAD ADJUSTING® MAX-AIR®	

### TOYOTA — Solara

2004- Jun 06	Todos								
	Derecho	72205	72207	904989	903904	—	802207	—	—
	Izquierdo	—	72208	904989 63619	903904 63619	—	802208	—	—

### TOYOTA — Tacoma

2016-22	RWD	73076●	37280	—	—	801371	—	—	—
	Plato de Montura Superior	—	—	907921	—	—	—	—	—
	4WD — Exc. TRD Pro	71371	37280 911547●	—	—	801371	—	—	—
	Plato de Montura Superior	—	—	907921	—	—	—	—	—
2005-15	4WD y Pre-Runner	71371	37280	—	—	801371	—	—	—
	Plato de Montura Superior	—	—	907921	—	—	—	—	—
	RWD Pickup Todos — Exc. c/ Paq. Offroad, PreRunner o X- Runner								
	Derecho	71105	37279	909913	—	—	—	—	—
	Izquierdo	71106	37279	909913	—	—	—	—	—
1998-04	PreRunner — c/ Doble Cabina								
	Derecho	71351	37113	904900	—	—	32294	—	—
	Izquierdo	71351	37114	904900	—	—	32295	—	—
	Plato de Montura Superior	—	—	907927	—	—	—	—	—
	PreRunner — Exc. Doble Cabina								
	Derecho	71352	37113	904900	—	—	32294	—	—
	Izquierdo	71352	37114	904900	—	—	32295	—	—
	Plato de Montura Superior	—	—	907927	—	—	—	—	—
1995-04	RWD — Exc. PreRunner	37111	37112	—	—	32292	32293	—	—
2005-15	4WD — Todos Inc. PreRunner	71371	37280	—	—	—	—	—	—
	Plato de Montura Superior	—	—	907921	—	—	—	—	—
1995-04	4WD — Exc. Doble Cabina								
	Derecho	71352	37113	904900	—	—	32294	—	—
	Izquierdo	71352	37114	904900	—	—	32295	—	—
	Plato de Montura Superior	—	—	907927	—	—	—	—	—
	4WD — Doble Cabina								
	Derecho	71351	37113	904900	—	—	32294	—	—
	Izquierdo	71351	37114	904900	—	—	32295	—	—
	Plato de Montura Superior	—	—	907927	—	—	—	—	—

### TOYOTA — Tercel

1995-99	Sedán (EL53)								
	Derecho	71654	71297■	901983	902986■	801654	—	—	—
	Izquierdo	71655	71297■	901983 63620	902986■ 63629	801655	—	—	—

### TOYOTA — Tundra

2007-21	Todos — Exc. TRD Pro	71119	37298	—	550064	—	—	—	—
	Plato de Montura Superior	—	—	907923	—	—	—	—	—
	Aislador de Resorte Superior	—	—	907924	—	—	—	—	—
2000-06	2WD	71347	37239	—	—	—	33213●	—	—
	Plato de Montura Superior	—	—	907925	—	—	—	—	—
	Aislador de Resorte Superior	—	—	907926	—	—	—	—	—

● Nuevo número de parte

■ Número de parte bajo pedido especial



## APLICACIONES

				BASES DE AMORTIGUADOR CUBREPOLVO		MONRO-MATIC HIDRÁULICO		LOAD ADJUSTING MAX-AIR	

### TOYOTA — Tundra (Cont.)

2000-06 (Cont.)	4WD Plato de Montura Superior Aislador de Resorte Superior	71347 — —	37238 — —	— 907925 907926	— — —	— — —	33208● — —	— — —	— — —
--------------------	--	-----------------	-----------------	-----------------------	-------------	-------------	------------------	-------------	-------------

### TOYOTA — Venza

2009-12	AWD								
	Derecho	72962■	72489	906986	—	—	—	—	—
	Izquierdo	72963■	72490	906986	—	—	—	—	—
	Aislador de Resorte Inferior	—	—	—	904953■	—	—	—	—
				63630	63640				
	FWD								
Derecho	72962■	72485	906986	902064●	—	—	—	—	
Izquierdo	72963■	72486	906986	902065●	—	—	—	—	
Aislador de Resorte Inferior	—	—	—	904953■	—	—	—	—	
			63630	63640					

### TOYOTA — Yaris

2015-18	Todos	—	5566●	—	—	—	—	—	—
2015	Todos								
	Derecho	72288	5566●	906989	—	—	—	—	—
	Izquierdo	72289	5566●	906989	—	—	—	—	—
				63630					
2012-14	Todos — Exc. SE								
	Derecho	72288	5624	906989	—	—	—	—	—
	Izquierdo	72289	5624	906989	—	—	—	—	—
				63630					
2006-11	Todos								
	Derecho	72288	5624	906989	—	—	—	—	—
	Izquierdo	72289	5624	906989	—	—	—	—	—
				63630					
2004-05	Todos	71575	—	—	—	—	—	—	—

### VOLKSWAGEN — Amarok

2010-18	Todos	71054	37355	—	—	—	—	—	—
---------	-------	-------	-------	---	---	---	---	---	---

### VOLKSWAGEN — Atlantic

1981-87	Todos	72826	—	—	—	—	MW202	—	—
---------	-------	-------	---	---	---	---	-------	---	---

### VOLKSWAGEN — Beetle

2019	Todos	72311	—	—	—	—	—	400021●	—
2016-18	Todos — Exc. R-Line	72311	5527	907949	907947	—	—	400021●	—
				63630					
2012-15	Todos	72311	5527	907949	907947	—	—	400021●	—
				63630					
1998-11	Todos	71525	5984	904905	904910	—	32403	400525	250984
				63631					

### VOLKSWAGEN — Bora

2005-11	Todos — Exc. GLI y c/ Suspensión Deportiva	72311	5611	907949	—	—	—	400021●	250011
	p/ Modelos c/ Tope de Rebote Redondo	—	—	—	907947	—	—	—	—
				63631	63636				

● Nuevo número de parte

■ Número de parte bajo pedido especial

## APLICACIONES

	<b>OESpectrum</b>	<b>GAS-MAGNUM®</b>		<b>MONRO-MATIC PLUS®</b>		<b>ROADMATIC</b>	
	<b>Reflex</b>	BASES DE AMORTIGUADOR CUBREPOLVO		MONRO-MATIC® HIDRÁULICO		LOAD ADJUSTING® MAX-AIR®	

### VOLKSWAGEN — Bora (Cont.)

2005-11 (Cont.)	GLI y c/ Suspensión Deportiva p/ Modelos c/ Tope de Rebote Redondo	72312	5611	907949	—	—	—	400032●	250011
		—	—	—	907947	—	—	—	—
				63631	63636				

### VOLKSWAGEN — Brasilia

1973-82	Todos	—	—	—	—	31538 1538	31089 1089	250538	250089
---------	-------	---	---	---	---	---------------	---------------	--------	--------

### VOLKSWAGEN — Cabrio

1995-02	Todos — Motor de 4 Cil.	—	71265	902906 <sup>[223]</sup>	901966	—	801265	—	—
				63618					
	Todos — Motor de 6 Cil.	—	71265	902906	901966	—	801265	—	—
				63618					

### VOLKSWAGEN — Cabriolet

1985-93	Convertible	72826	—	—	901966	—	MW202	—	—
				63618					

### VOLKSWAGEN — Caddy

2014-20	Todos	72311	—	—	—	—	—	400021●	—
---------	-------	-------	---	---	---	---	---	---------	---

### VOLKSWAGEN — Caribe

1977-87	Todos	72826	—	—	901966	—	MW202	—	—
---------	-------	-------	---	---	--------	---	-------	---	---

### VOLKSWAGEN — CC

2009-17	Todos	72311	5611	907949	—	—	—	400021●	250011
				63632	63636				

### VOLKSWAGEN — Crafter

2012-13	Todos	—	37319	—	—	—	—	—	—
---------	-------	---	-------	---	---	---	---	---	---

### VOLKSWAGEN — Crossfox

2005-17	Todos	—	—	906905	904910	801052	33160	—	—
---------	-------	---	---	--------	--------	--------	-------	---	---

### VOLKSWAGEN — Derby

1999-09	Todos	—	—	906905	—	MW009	MW013	—	—
1993-98	Todos	—	—	902906	901966	—	—	—	—
				63618					

### VOLKSWAGEN — Derby Van

2002-07	Todos	—	—	—	—	MW009	—	—	—
---------	-------	---	---	---	---	-------	---	---	---

### VOLKSWAGEN — Eos

2007-16	Todos	72311	—	907949	907947	—	—	400021●	—
				63631	63636				

### VOLKSWAGEN — Eurovan TDI

2005-09	Diesel	72519	37319	—	—	—	—	—	—
---------	--------	-------	-------	---	---	---	---	---	---

### VOLKSWAGEN — Gol

2008-18	Todos — Todos s/ barra estabilizadora	72633	72634	—	—	—	—	—	—
2008-20	Todos — Todos c/ barra estabilizadora	72745	72634	—	—	—	—	—	—

● Nuevo número de parte

<sup>[223]</sup> No funciona con EO #31331139437



## APLICACIONES

		GAS-MAGNUM® BASES DE AMORTIGUADOR CUBREPOLVO		MONRO-MATIC PLUS® MONRO-MATIC® HIDRÁULICO		ROADMATIC LOAD ADJUSTING MAX-AIR®	

### VOLKSWAGEN — Gol Sedán

2010-13	Todos — s/ barra estabilizadora	72633	72634	—	—	—	—	—	—
---------	---------------------------------	-------	-------	---	---	---	---	---	---

### VOLKSWAGEN — Golf A4

1999-07	Hatchback — Exc. R32	71525	5984	904905 63631	904910	—	32403	400525	250984
---------	----------------------	-------	------	-----------------	--------	---	-------	--------	--------

### VOLKSWAGEN — Golf A3

1993-98	Hatchback c/ Motor 4 Cilindros — Exc. c/ Frenos ABS	71933	71265	902906 <sup>(49)</sup> 63618	901966	801933 MW933	801265 MW265	400933	400265
	Hatchback c/ Motor 6 Cilindros — Exc. c/ Frenos ABS	—	—	902906 <sup>(49)</sup> 63618	901966	—	—	—	—

### VOLKSWAGEN — Golf A2

1992	Hatchback	71853	71265	901904 63630	901966	801853 MW853	801265 MW265	—	400265
1985-91	Hatchback c/ Strut Sellado	71853	71265	901904 63630	901966	801853 MW853	801265 MW265	—	400265
	Hatchback s/ Strut Sellado	—	71265	901904 63618	901966	—	801265	—	—

### VOLKSWAGEN — Golf SportWagen

2010-13	Todos	72311	5611	907949	907947	—	—	400021●	250011
---------	-------	-------	------	--------	--------	---	---	---------	--------

### VOLKSWAGEN — GTI

Mayo 2006-14	Todos — c/ Chassis PQ35	72312	5611	907949	907947	—	—	400032●	250011
-----------------	-------------------------	-------	------	--------	--------	---	---	---------	--------

### VOLKSWAGEN — Jetta

2019	Todos	72311	—	—	—	—	—	—	—
2016-18	Todos	72311	5528	907949 63631	907947 63636	—	—	400021●	—
2015	Base y S de 2.0L c/ Montura inferior de 55 mm	72311	5528	907949 63631	907947 63636	—	—	400021●	—
2011-15	Sedán (Nuevo Modelo) Base y S de 2.0L c/ Montura inferior de 50 mm p/ Modelos c/ Tope de Rebote Redondo	72549	5553●	907949	—	—	—	—	—
		—	—	—	907947	—	—	—	—
2011-14	Sedán (Nuevo Modelo) Exc. Base, S, GLI e Híbrido c/ Montura inferior de 55 mm p/ Modelos c/ Tope de Rebote Redondo	72311	5553●	907949	—	—	—	400021●	—
		—	—	—	907947	—	—	—	—

### VOLKSWAGEN — Jetta Clasico

2011-15	Jetta Clasico — Sedán	71525	5984	904905 63631	904910 63636	—	32403	400525	250984
---------	-----------------------	-------	------	-----------------	-----------------	---	-------	--------	--------

● Nuevo número de parte

<sup>(49)</sup> La herramienta especial AK73 está disponible para retirar e instalar esta base de amortiguador.

## APLICACIONES

	<b>OESpectrum</b> <i>Reflex</i>	<b>GAS-MAGNUM®</b> BASES DE AMORTIGUADOR CUBREPOLVO		<b>MONRO-MATIC PLUS®</b> MONRO-MATIC® HIDRÁULICO		<b>ROADMATIC</b> LOAD ADJUSTING® MAX-AIR®	

### VOLKSWAGEN — Jetta A4

2001-03	Station Wagon	71525	5613■	904905	904910	—	—	400525	—
1999-10	Sedán	71525	5984	904905 63631	904910 63636	—	32403	400525	250984

### VOLKSWAGEN — Jetta A3

1993-98	Todos — c/ Motor 4 Cilindros	71933	71265	901904 63618	901966	801933 MW933	801265 MW265	400933	400265
	Todos — c/ Motor 6 Cilindros — Exc. c/ Frenos ABS	—	71265	901904 63618	901966	—	801265 MW265	—	400265

### VOLKSWAGEN — Jetta A2

1985-91	Sedán — c/ Strut Sellado	71853	71265	901904 63618	901966	801853 MW853	801265 MW265	—	400265
---------	--------------------------	-------	-------	-----------------	--------	-----------------	-----------------	---	--------

### VOLKSWAGEN — Lupo

2003-09	Todos	71029	5791	906905	904910	—	—	400029	250791
---------	-------	-------	------	--------	--------	---	---	--------	--------

### VOLKSWAGEN — Nuevo Gol

2014-16	Todos — s/ Barra Estabilizadora	72633	72634	—	—	—	—	—	—
---------	---------------------------------	-------	-------	---	---	---	---	---	---

### VOLKSWAGEN — Passat

2012-222	Todos	72311	5529	907949 63631	— 63636	—	—	400021●	—
2006-10	Todos — Exc. AWD y c/ Susp. Deportiva	72311	5611	907949	—	—	—	400021●	250011
	Todos — c/ Suspensión Sport	72312	—	907949	—	—	—	400032●	—
2006-08	Todos — c/ 4WD (Moción 4) Exc. c/ Susp. Sport	72311	—	907949	—	—	—	400021●	—
2001-05	Sedán — Exc. AWD	71335	39102	904992	904909	—	—	—	—
	Sedán — c/ 4WD (Moción 4)	—	71334	904992	—	—	—	—	—
1998-00	Todos — Exc. c/ Syncro 4WD	71304■	39102	904992	—	—	—	—	—
	Sedán y Wagon — c/ Syncro 4WD	71304■	71334	904992	—	—	—	—	—
1993-97	Sedán — Exc. VR6	—	—	901904 63618	—	—	—	—	—
	Sedán y Wagon — c/ Syncro 4WD	—	—	902906 63618	—	—	—	—	—

### VOLKSWAGEN — Passat CC

2009-12	Todos	72311	5611	907949 63631	— 63636	—	—	400021●	250011
---------	-------	-------	------	-----------------	------------	---	---	---------	--------

### VOLKSWAGEN — Pointer

1998-09	Todos	—	—	904967	—	MC888	MW005	400888	400005
---------	-------	---	---	--------	---	-------	-------	--------	--------

### VOLKSWAGEN — Pointer Pickup

1998-10	Todos	—	—	—	—	MC888	MW014	400888	400014
---------	-------	---	---	---	---	-------	-------	--------	--------

### VOLKSWAGEN — Polo

2013-20	Todos	71058	5507	—	—	—	—	—	—
2003-08	Todos	71029	5791	906905	904910	—	—	400029	250791

● Nuevo número de parte

■ Número de parte bajo pedido especial





## APLICACIONES

<b>VOLKSWAGEN — Routan</b>									
2009-12	Todos — Exc. Nivomat	71128	37290	906960	—	—	—	—	—
	Todos — c/ Nivomat	71128	—	—	—	—	—	—	—
<b>VOLKSWAGEN — Safari</b>									
1973-80	Todos	—	—	—	—	31538 1538	31089 1089	250538	250089
<b>VOLKSWAGEN — Saveiro</b>									
2008-20	Todos	71055	5506	—	—	—	—	—	—
<b>VOLKSWAGEN — Sedán</b>									
1973-04	Todos	—	—	—	—	31538 1538	31089 1089	250538	250089
1953-72	Todos	—	—	—	—	31089 1089	31089 1089	250089	250089
<b>VOLKSWAGEN — Sharan</b>									
2002-08	Todos	71033	5781	902906	—	—	—	—	—
<b>VOLKSWAGEN — SportVan</b>									
2008-10	Todos	—	5608	—	904910	—	—	—	—
2006-07	Todos	71048	5608	—	904910	—	—	—	—
<b>VOLKSWAGEN — Tiguan</b>									
2009-17	Todos	72312	5518	907949 63640	—	—	—	400032●	—
<b>VOLKSWAGEN — Touareg</b>									
2004-12	Todos	—	—	—	—	—	—	—	—
	Derecho	72476	72478	904992	904992	—	—	—	—
	Izquierdo	72477	72478	904992	904992	—	—	—	—
<b>VOLKSWAGEN — Transporter</b>									
2010-20	Todos	72519	37319	902129●	—	—	—	—	—
<b>VOLKSWAGEN — Van Caravelle</b>									
1972-95	Todos	—	—	—	34732	2592	2545	—	—
<b>VOLKSWAGEN — Van Combi</b>									
1972-01	Todos	—	—	—	34732	2592	2545	—	—
<b>VOLKSWAGEN — Van Eurovan</b>									
2006-09	Todos	—	—	902129●	—	—	—	—	—
1993-04	Todos	37195	—	—	—	—	—	—	—
<b>VOLKSWAGEN — Van Panel</b>									
1972-95	Todos	—	—	—	34732	2592	2545	—	—
<b>VOLKSWAGEN — Van Vanagon</b>									
1980-91	Todos — Exc. Syncro	37348	37349■	—	—	—	—	—	—
<b>VOLKSWAGEN — Vento</b>									
2013-17	Todos	71058	—	904905	—	—	—	—	—
<b>VOLVO — S40</b>									
2005-11	Sedán — Exc. AWD	—	—	—	—	—	—	—	—
	Derecho	72315	5617	906980	—	—	—	—	—
	Izquierdo	72316	5617	906980	—	—	—	—	—

● Nuevo número de parte

■ Número de parte bajo pedido especial



## APLICACIONES

	<b>OESpectrum</b>	<b>GAS-MAGNUM®</b>	<b>MONRO-MATIC PLUS®</b>	<b>ROADMATIC</b>
	<b>Reflex</b>	<b>BASES DE AMORTIGUADOR</b>	<b>MONRO-MATIC® HIDRÁULICO</b>	<b>LOAD ADJUSTING®</b>
		<b>CUBREPOLVO</b>		<b>MAX-AIR®</b>

### VOLVO — S40 (Cont.)

Abril 2000-04	Sedán — Exc. 2.4i y T5								
	Derecho	71483	—	905959	—	—	—	—	—
	Izquierdo	71484	—	905959	—	—	—	—	—

### VOLVO — V40

Abril 2000-04	Wagon								
	Derecho	71483	—	905959	—	—	—	—	—
	Izquierdo	71484	—	905959	—	—	—	—	—

### VOLVO — V50

Abril 2005-11	Wagon — Exc. AWD								
	Derecho	72315	5617	906980	—	—	—	—	—
	Izquierdo	72316	5617	906980	—	—	—	—	—

### VOLVO — S60

2001-09	FWD — Exc. c/ Susp. Elect. Autoajustable	71485	39040	904903	—	—	—	—	—
	Asiento de Resorte Superior	—	—	903978	—	—	—	—	—
	Aislador de Resorte Inferior	—	—	906941 ■	—	—	—	—	—
				63633					

### VOLVO — C70

2008-13	Todos								
	Derecho	72315	—	906980	—	—	—	—	—
	Izquierdo	72316	—	906980	—	—	—	—	—
1998-04	Coupé y Convertible	71699	5975 ■	904903	—	—	—	—	—
	Asiento de Resorte Superior	—	—	903978	—	—	—	—	—
				63633					

### VOLVO — V70

Feb 2000-07	Wagon 2WD	71485	39040	904903	—	—	—	—	—
	Asiento Resorte Superior	—	—	903978	—	—	—	—	—
	Aislador de Resorte Inferior	—	—	906941 ■	—	—	—	—	—
				63633					

### VOLVO — S80

2010-16	Todos — Exc. c/ Susp. Electronica Ajustable	—	—	909981	—	—	—	—	—
Mar 2006-15	Todos — Exc. c/ Susp. Trasera Nivomat y Four—C								
	Derecho	—	5666	—	—	—	—	—	—
	Izquierdo	72637 ■	5666	—	—	—	—	—	—
1999-Jul 06	Sedán — Exc. c/ Susp. Trasera Nivomat	71485	39040	904903	—	—	—	—	—
	Asiento de Resorte Superior	—	—	903978	—	—	—	—	—
	Aislador de Resorte Inferior	—	—	906941 ■	—	—	—	—	—

### VOLVO — XC60

2010-17	Todos — Exc. CES								
	Derecho	—	5522	909981	—	—	—	—	—
	Izquierdo	—	5522	909981	—	—	—	—	—

■ Número de parte bajo pedido especial

The Rancho logo is rendered in a bold, italicized, metallic font with a 3D effect. It is enclosed within a dark, glossy oval shape that has a slight glow and a shadow, giving it a sense of depth and movement. The background of the entire page is a grayscale photograph of a vehicle's rear suspension system, showing the axle, shock absorbers, and tires, which is slightly faded to allow the text to stand out.

**RANCHO**

**AMORTIGUADORES Y SUSPENSIONES  
DE ALTO DESEMPEÑO**

**APLICACIONES  
CAMIONETAS Y SUV'S**

**CATÁLOGO 2023**

AÑO	APLICACIÓN	ALTURA	RS9000XL		RS7000MT		RS5000/RS500X	
			DELANTERO	TRASERO	DELANTERO	TRASERO	DELANTERO	TRASERO
<b>CHEVROLET</b>								
2007-13	Avalanche 4WD 1500 c/ RS6582 o RS6582B - Exc. AWD y c/ Susp. Aire o Electrónica.	4"	RS999786 <sup>XL</sup>	RS999274 <sup>XL</sup>	-	-	RS55786 <sup>X</sup>	-
2007-13	Avalanche 4WD 1500 - Exc. c/ Sus. de Aire o Electrónica	E.O.	RS999784 <sup>XL</sup>	RS999262 <sup>XL</sup>	-	-	-	RS55262 <sup>X</sup>
2007-13	Avalanche 4WD 1500 - Exc. AWD, Autoride, AutoTrack y c/ Sus. de Aire o Electrónica	2"	-	-	-	-	RS55785 <sup>X</sup>	-
2002-13	Avalanche 4WD 1500 - Exc. c/ Sus. Electrónica, AWD, Autoride y Z71	3/4"	-	-	-	-	-	RS55262 <sup>X</sup>
2002-13	Avalanche 4WD 1500 - Inc. Sport Utility Truck - Exc. Autoride y Sus. de Aire	E.O.	-	-	-	-	-	RS55262 <sup>X</sup>
2002-06	Avalanche 4WD 1500 - Exc. c/ Susp. Electrónica	5 - 6"	RS999057 <sup>XL</sup>	RS999058 <sup>XL</sup>	-	-	-	-
2002-06	Avalanche 4WD 1500 - Exc. Transmisión Manual o AWD	4"	-	-	-	-	-	RS55724 <sup>X</sup>
2002-06	Avalanche 4WD 1500 - Exc. c/ Susp. Electrónica	2"	-	-	-	-	-	RS55724 <sup>X</sup>
2002-06	Avalanche 4WD 1500 c/ RS6547 - Exc. c/ Susp. Electrónica, AWD Autoride y Z71	E.O.	-	-	-	-	-	RS55724 <sup>X</sup>
2002-06	Avalanche 4WD 1500 - Exc. AWD	E.O.	RS999265 <sup>XL</sup>	RS999262 <sup>XL</sup>	-	-	RS55265 <sup>X</sup>	RS55262 <sup>X</sup>
2002-06	Avalanche 4WD 2500 - Exc. AWD	5 - 6"	RS999055 <sup>XL</sup>	RS999056 <sup>XL</sup>	-	-	-	-
2002-06	Avalanche 4WD 2500 - Exc. AWD	2"	-	-	-	-	-	RS55297 <sup>X</sup>
2002-13	Avalanche 4WD 2500 - Sport Utility Truck	E.O.	-	-	-	-	-	RS55262 <sup>X</sup>
2002-06	Avalanche 4WD 2500 - Todos	E.O.	RS999295 <sup>XL</sup>	RS999262 <sup>XL</sup>	-	-	RS5295	RS55262 <sup>X</sup>
2007-13	Avalanche 2WD 1500 - Exc. c/ Sus. Electrónica	E.O.	RS999784 <sup>XL</sup>	RS999262 <sup>XL</sup>	-	-	-	RS55262 <sup>X</sup>
2007-13	Avalanche 2WD 1500 - Exc. c/ Sus. Electrónica	2"	-	-	-	-	RS55785 <sup>X</sup>	RS55262 <sup>X</sup>
2000-06	Avalanche 2WD 1500 - Exc. c/ Susp. Electrónica	E.O.	RS999265 <sup>XL</sup>	RS999262 <sup>XL</sup>	-	-	RS55265 <sup>X</sup>	RS55262 <sup>X</sup>
2002-13	Avalanche 2WD 1500 - Exc. c/ Sus. Electrónica, AWD, Autoride y Z71	3/4"	-	-	-	-	-	RS55262 <sup>X</sup>
2002-13	Avalanche 2WD 1500 - Inc. Sport Utility Truck - Exc. Autoride & Sus. de Aire	E.O.	-	-	-	-	-	RS55262 <sup>X</sup>
2002-13	Avalanche 2WD 2500 Sport Utility Truck	E.O.	-	-	-	-	-	RS55262 <sup>X</sup>
2002-05	Avalanche 2WD 2500 Sport Utility Truck	2 1/2"	-	-	-	-	-	RS55724 <sup>X</sup>
1995-05	Blazer 4WD c/ Paquete ZR2 Highrider - Inc. Paquete Deportivo	E.O.	RS999123 <sup>XL</sup> 1	RS999190 <sup>XL</sup>	-	RS7190	RS55123 <sup>X</sup> 1	RS55190 <sup>X</sup>
1983-05	Blazer 4WD Inc. Paquete Deportivo - Exc. c/ Paq. ZR2 Highrider	E.O.	RS999123 <sup>XL</sup> 1	RS999124 <sup>XL</sup>	-	-	RS55123 <sup>X</sup> 1	RS55124 <sup>X</sup>
1983-05	Blazer y S-10 2WD	E.O.	-	RS999124 <sup>XL</sup>	-	-	-	RS55124 <sup>X</sup>
2014-18	Pickup (1/2 Ton) 4WD Silverado 1500 - Exc. Control de Manejo Electrónico ZX3 y AWD	E.O.	RS999830 <sup>XL</sup>	RS999198 <sup>XL</sup>	-	-	RS55830 <sup>X</sup>	RS55198 <sup>X</sup>
1999-16	Pickup (1/2 Ton) 4WD Silverado 1500 - Exc. 1500HD, Control de Manejo Electrónico ZX3, QuadraSteer, Autoride, c/ Susp. de Aire y AWD	E.O.	-	-	-	-	-	RS55198 <sup>X</sup>
2007-13	Pickup (1/2 Ton) 4WD Silverado 1500 - (Nuevo modelo) Exc. 1500HD, Control de Manejo Electrónico ZX3 y AWD	2"	-	-	-	-	RS55785 <sup>X</sup>	RS55198 <sup>X</sup>
2007-13	Pickup (1/2 Ton) 4WD Silverado 1500 - Exc. 1500HD, Control de Manejo Electrónico ZX3 y AWD	E.O.	RS999784 <sup>XL</sup>	RS999198 <sup>XL</sup>	-	RS7198	-	RS55198 <sup>X</sup>
2005-07	Pickup (1/2 Ton) 4WD Silverado 1500HD Crew Cab - Exc. c/ Susp. Elect.	5 - 6"	RS999055 <sup>XL</sup>	RS999056 <sup>XL</sup>	-	-	-	-
2005-07	Pickup (1/2 Ton) 4WD Silverado 1500HD Crew Cab - Exc. c/ Susp. Elect.	E.O.	RS999295 <sup>XL</sup>	RS999274 <sup>XL</sup>	-	-	RS5295	RS55274 <sup>X</sup>
1999-08	Pickup (1/2 Ton) 4WD Silverado 1500 Clásico - Exc. Control de Manejo Electrónico ZX3	E.O.	-	-	-	-	-	RS55297 <sup>X</sup>
1999-07	Pickup (1/2 Ton) 4WD Silverado 1500 Clásico	5 - 6"	RS999057 <sup>XL</sup>	RS999297 <sup>XL</sup>	-	-	-	-
1999-07	Pickup (1/2 Ton) 4WD Silverado 1500 Clásico - Exc. 1500HD y c/ Susp. Elect.	E.O.	RS999265 <sup>XL</sup>	RS999198 <sup>XL</sup>	-	RS7198	RS55265 <sup>X</sup>	RS55198 <sup>X</sup>
1999-07	Pickup (1/2 Ton) 4WD Silverado 1500 Clásico c/ Susp. Del. de Barra de Torsión - Exc. Control de Manejo Electrónico ZX3	E.O.	-	-	-	-	-	RS55198 <sup>X</sup>
2001-03	Pickup (1/2 Ton) 4WD Silverado 1500HD Crew Cab - Exc. c/ Susp. Elect.	5 - 6"	RS999055 <sup>XL</sup>	RS999056 <sup>XL</sup>	-	-	-	-



AÑO	APLICACIÓN	ALTURA	RS9000XL		RS7000MT		RS5000/RS500X	
			DELANTERO	TRASERO	DELANTERO	TRASERO	DELANTERO	TRASERO
<b>CHEVROLET (CONT.)</b>								
2001-03	Pickup (1/2 Ton) 4WD Silverado 1500HD Crew Cab - Exc. c/ Susp. Elect.	E.O.	RS999295 <sup>XL</sup>	RS999274 <sup>XL</sup>	-	-	RS5295	RS55274 <sup>X</sup>
1988-98	Pickup (1/2 Ton) 4WD K-1500	5 - 6"	RS999059 <sup>XL</sup>	RS999060 <sup>XL</sup>	-	-	-	-
1988-98	Pickup (1/2 Ton) 4WD K-1500	E.O.	RS999 <sup>152XL</sup>	RS999190 <sup>XL</sup>	RS7150	RS7190	RS5 <sup>152</sup> RS55 <sup>152X</sup>	RS55190 <sup>X</sup>
2014-18	Pickup (1/2 Ton) 4WD Silverado 1500 - Exc. Control de Manejo Electrónico ZX3 y AWD	E.O.	RS999830 <sup>XL</sup>	RS999198 <sup>XL</sup>	-	-	RS55830 <sup>X</sup>	RS55198 <sup>X</sup>
1999-18	Pickup (1/2 Ton) 2WD Silverado 1500 - Exc. Control de Manejo Electrónico ZX3, AWD y QuadraSteer	E.O.	-	-	-	-	-	RS55198 <sup>X</sup>
2007-13	Pickup (1/2 Ton) 4WD Silverado 1500 - (Nuevo modelo) Exc. 1500HD, Control de Manejo Electrónico ZX3 y AWD	2"	-	-	-	-	RS55785 <sup>X</sup>	RS55198 <sup>X</sup>
2007-13	Pickup (1/2 Ton) 2WD Silverado 1500 - Exc. Control de Manejo Electrónico ZX3 y QuadraSteer	E.O.	RS999784 <sup>XL</sup>	RS999198 <sup>XL</sup>	-	RS7198	-	RS55198 <sup>X</sup>
1999-13	Pickup (1/2 Ton) 2WD Silverado 1500 c/ Sistema RS6583 o RS6583B	4"	-	-	-	-	-	RS55269 <sup>X</sup>
1999-13	Pickup (1/2 Ton) 2WD Silverado 1500 c/ Transmisión Automática	4"	-	-	-	-	-	RS55269 <sup>X</sup>
2005-07	Pickup (1/2 Ton) 2WD Silverado 1500HD c/ 9,200 lbs. de PBV	E.O.	RS999295 <sup>XL</sup>	RS999274 <sup>XL</sup>	-	-	RS5295	RS55274 <sup>X</sup>
2004-07	Pickup (1/2 Ton) 2WD Silverado 1500 c/ Susp. Del. de Barra de Torsión Exc. Control de Manejo Electrónico ZX3 y QuadraSteer	E.O.	RS999265 <sup>XL</sup>	RS999198 <sup>XL</sup>	-	RS7198	RS55265 <sup>X</sup>	RS55198 <sup>X</sup>
1999-07	Pickup (1/2 Ton) 2WD Silverado 1500 c/ Susp. Del. de Barra de Resorte Exc. Control de Manejo Electrónico ZX3 y Paquete QuadraSteer	E.O.	RS999263 <sup>XL</sup>	RS999262 <sup>XL</sup>	-	-	RS55263 <sup>X</sup>	RS55262 <sup>X</sup>
2001-03	Pickup (1/2 Ton) 2WD Silverado 1500HD - Exc. Control de Manejo Electrónico ZX3 y QuadraSteer	E.O.	RS999295 <sup>XL</sup>	RS999274 <sup>XL</sup>	-	-	RS5295	RS55274 <sup>X</sup>
1988-98	Pickup (1/2 Ton) 2WD C-1500	E.O.	RS999166 <sup>XL</sup>	RS999190 <sup>XL</sup>	-	RS7190	-	RS55190 <sup>X</sup>
1988-98	Pickup (1/2 Ton) 2WD C-1500 c/ Sistema Rancho® RS6243	4"	-	-	-	-	RS55128 <sup>X</sup>	-
1987	Pickup (1/2 Ton) 2WD R-10	1 1/2"	RS999120 <sup>XL</sup>	RS999118 <sup>XL</sup>	-	RS7118	-	RS55118 <sup>X</sup>
1973-86	Pickup (1/2 Ton) 2WD C-10	1 1/2"	RS999120 <sup>XL</sup>	RS999118 <sup>XL</sup>	-	RS7118	-	RS55118 <sup>X</sup>
2011-22	Pickup 4WD (3/4 Ton) Silverado 2500HD	1 - 2 1/2"	-	-	-	-	RS55378 <sup>X</sup> <sub>313</sub>	-
2011-22	Pickup 4WD (3/4 Ton) Silverado 2500HD	E.O.	RS999377 <sup>XL</sup>	RS999379 <sup>XL</sup>	-	-	RS55377 <sup>X</sup>	RS55379 <sup>X</sup>
2011-18	Pickup 4WD (3/4 Ton) Silverado 2500HD	5 - 6"	-	-	-	-	RS55382 <sup>X</sup>	RS55383 <sup>X</sup>
2011-18	Pickup 4WD (3/4 Ton) Silverado 2500HD	4"	RS999380 <sup>XL</sup>	RS999381 <sup>XL</sup>	-	-	RS55380 <sup>X</sup>	RS55381 <sup>X</sup>
2001-10	Pickup 4WD (3/4 Ton) Silverado 2500HD c/ 9,200 lb. PBV	5 - 6"	RS999055 <sup>XL</sup>	RS999056 <sup>XL</sup>	-	-	-	-
2001-10	Pickup 4WD (3/4 Ton) Silverado 2500HD c/ 9,200 lb. PBV	E.O.	RS999288 <sup>XL</sup>	RS999274 <sup>XL</sup>	-	-	RS55288 <sup>X</sup>	RS55274 <sup>X</sup>
1999-04	Pickup 4WD (3/4 Ton) Silverado 2500 h/ 8,600 lb. PBV - Exc. QuadraSteer	5 - 6"	RS999055 <sup>XL</sup>	RS999056 <sup>XL</sup>	-	-	-	-
1999-04	Pickup 4WD (3/4 Ton) Silverado 2500 h/ 8,600 lb. PBV - Exc. QuadraSteer	E.O.	RS999295 <sup>XL</sup>	RS999274 <sup>XL</sup>	-	-	RS5295	RS55274 <sup>X</sup>
1988-00	Pickup 4WD (3/4 Ton) K-2500	E.O.	RS999 <sup>152XL 148</sup>	RS999190 <sup>XL</sup>	RS7150	RS7190	RS55150 <sup>X</sup>	RS55190 <sup>X</sup>
2011-22	Pickup 2WD (3/4 Ton) Silverado 2500HD	1 - 2 1/2"	-	-	-	-	RS55378 <sup>X</sup> <sub>313</sub>	-
2011-22	Pickup 2WD (3/4 Ton) Silverado 2500HD	E.O.	RS999377 <sup>XL</sup>	RS999379 <sup>XL</sup>	-	-	RS5377	RS55379 <sup>X</sup>
			-	-	-	-	RS55377 <sup>X</sup>	-
2011-18	Pickup 2WD (3/4 Ton) Silverado 2500HD	5 - 6"	-	-	-	-	RS55382 <sup>X</sup>	RS55383 <sup>X</sup>
2011-18	Pickup 2WD (3/4 Ton) Silverado 2500HD	4"	RS999380 <sup>XL</sup>	RS999381 <sup>XL</sup>	-	-	RS55380 <sup>X</sup>	RS55381 <sup>X</sup>
2001-10	Pickup 2WD (3/4 Ton) Silverado 2500HD c/ 9,200 lb. PBV	5 - 6"	RS999055 <sup>XL</sup>	RS999056 <sup>XL</sup>	-	-	-	-

AÑO	APLICACIÓN	ALTURA	RS9000XL		RS7000MT		RS5000/RS500X	
			DELANTERO	TRASERO	DELANTERO	TRASERO	DELANTERO	TRASERO
<b>CHEVROLET (CONT.)</b>								
2001-10	Pickup 2WD (3/4 Ton) Silverado 2500HD c/ 9,200 lb. PBV c/ RS6548 o RS6548B	4"	RS999289 <sup>XL</sup>	RS999297 <sup>XL</sup>	-	-	RS55289 <sup>X</sup>	-
2001-10	Pickup 2WD (3/4 Ton) Silverado 2500HD c/ 9,200 lb. PBV	E.O.	-	-	-	-	-	RS55297 <sup>X</sup>
2001-10	Pickup 2WD (3/4 Ton) Silverado 2500HD c/ 9,200 lb. PBV	E.O.	RS999288 <sup>XL</sup>	RS999274 <sup>XL</sup>	-	-	RS55288 <sup>X</sup>	RS55274 <sup>X</sup>
1999-04	Pickup 2WD (3/4 Ton) Silverado 2500 h/ 8,600 lb. PBV - Exc. Quadrateer	E.O.	RS999263 <sup>XL</sup>	RS999274 <sup>XL</sup>	-	-	RS55263 <sup>X</sup>	RS55274 <sup>X</sup>
1988-00	Pickup 2WD (3/4 Ton) C-2500	E.O.	RS999166 <sup>XL 24</sup>	RS999190 <sup>XL</sup>	-	RS7190	-	RS55190 <sup>X</sup>
1988-98	Pickup 2WD (3/4 Ton) C-2500 c/ RS6243	4"	-	-	-	-	RS55128 <sup>X</sup>	-
2011-22	Pickup 4WD (3/4 Ton) Silverado 3500HD	1 - 2 1/2"	-	-	-	-	RS55378 <sup>X 313</sup>	-
2011-22	Pickup 4WD (1 Ton) Silverado 3500HD	E.O.	RS999377 <sup>XL</sup>	RS999379 <sup>XL</sup>	-	-	RS5377	RS55379 <sup>X</sup>
							RS55377 <sup>X</sup>	
2011-18	Pickup 4WD (1 Ton) Silverado 3500HD	5 - 6"	-	-	-	-	RS55382 <sup>X</sup>	RS55383 <sup>X</sup>
2011-18	Pickup 4WD (1 Ton) Silverado 3500HD	4"	RS999380 <sup>XL</sup>	RS999381 <sup>XL</sup>	-	-	RS55380 <sup>X</sup>	RS55381 <sup>X</sup>
2001-10	Pickup 4WD (1 Ton) Silverado 3500 c/ 11,400 lb. PBV Inc. Chassis Cab	E.O.	RS999288 <sup>XL</sup>	RS999262 <sup>XL</sup>	-	-	RS55288 <sup>X</sup>	RS55262 <sup>X</sup>
1988-00	Pickup 4WD (1 Ton) K-3500	E.O.	RS999150 <sup>XL</sup>	RS999190 <sup>XL</sup>	RS7150	RS7190	RS55150 <sup>X</sup>	RS55190 <sup>X</sup>
2011-22	Pickup 4WD (3/4 Ton) Silverado 3500HD	1 - 2 1/2"	-	-	-	-	RS55378 <sup>X 313</sup>	-
2011-22	Pickup 2WD (1 Ton) Silverado 3500HD	E.O.	RS999377 <sup>XL</sup>	RS999379 <sup>XL</sup>	-	-	RS5377	RS55379 <sup>X</sup>
							RS55377 <sup>X</sup>	
2011-18	Pickup 2WD (1 Ton) Silverado 3500HD	5 - 6"	-	-	-	-	RS55382 <sup>X</sup>	RS55383 <sup>X</sup>
2011-18	Pickup 2WD (1 Ton) Silverado 3500HD	4"	RS999380 <sup>XL</sup>	RS999381 <sup>XL</sup>	-	-	RS55380 <sup>X</sup>	RS55381 <sup>X</sup>
2001-10	Pickup (1 Ton) 2WD Silverado 3500 c/ Susp. Del. Indep. - Inc. Chasis Cab	E.O.	RS999288 <sup>XL</sup>	RS999262 <sup>XL</sup>	-	-	RS55288 <sup>X</sup>	RS55262 <sup>X</sup>
1992-00	Pickup (1Ton) 2WD C-3500 Crew Cab	E.O.	RS999166 <sup>XL 24</sup>	RS999190 <sup>XL</sup>	-	RS7190	-	RS55190 <sup>X</sup>
1987-00	Pickup (1 Ton) 2WD C-3500 - Exc. Crew Cab y Modelos 3500HD	E.O.	RS999166 <sup>XL 24</sup>	RS999190 <sup>XL</sup>	-	RS7190	-	RS55190 <sup>X</sup>
1973-86	Pickup (1Ton) 2WD C-30,R-30,R-3500 - Inc. Crew Cab	E.O.	RS999120 <sup>XL</sup>	RS999118 <sup>XL</sup>	-	RS7118	-	RS55118 <sup>X</sup>
2015-22	Pickup 4WD Colorado	E.O.	-	-	-	-	RS55840 <sup>X</sup>	RS550 <sup>23X</sup>
2004-12	Pickup 4WD Colorado - c/ Rancho RS6569B c/ Eje de transmisión de aluminio trasero	4"	-	-	-	-	RS55610 <sup>X</sup>	RS55301 <sup>X</sup>
2004-12	Pickup 4WD Colorado - c/ Rancho RS6569B Exc. c/ Eje de transmisión de aluminio trasero	4"	-	-	-	-	RS55610 <sup>X</sup>	RS55325 <sup>X</sup>
2004-12	Pickup 4WD Colorado	E.O.	RS999300 <sup>XL</sup>	RS999301 <sup>XL</sup>	-	-	-	RS55301 <sup>X</sup>
2015-22	Pickup 2WD Colorado	E.O.	-	-	-	-	RS55840 <sup>X</sup>	RS550 <sup>23X</sup>
2004-12	Pickup 2WD Colorado - c/ Rancho RS6569B c/ Eje de transmisión de aluminio trasero	4"	-	-	-	-	RS55610 <sup>X</sup>	RS55301 <sup>X</sup>
2004-12	Pickup 2WD Colorado - c/ Rancho RS6569B Exc. c/ Eje de transmisión de aluminio trasero	4"	-	-	-	-	RS55610 <sup>X</sup>	RS55325 <sup>X</sup>
2004-09	Pickup 2WD Colorado c/ Susp. Del. de Resorte - Exc. Z71	E.O.	-	RS999299 <sup>XL</sup>	-	-	RS5770	-
2004-09	Pickup 2WD Colorado c/ Susp. Del. de Barra de Torsión y Z71	E.O.	RS999300 <sup>XL</sup>	RS999301 <sup>XL</sup>	-	-	-	RS55301 <sup>X</sup>
1979-83	Pickup 4WD LUV	0 - 2"	-	-	-	RS7113	-	RS55113 <sup>X</sup>
1972-83	Pickup 2WD LUV	0 - 2"	-	-	-	RS7113	-	RS55113 <sup>X</sup>
2015-19	Suburban 1500 (1/2 Ton) 4WD - Exc. Modelos c/ Z95 Magnetic Ride Control o Z85 Increased Capacity Chassis	0"	RS999830 <sup>XL</sup>	RS999262	-	RS7262	RS55830 <sup>X</sup>	RS55262 <sup>X</sup>
2015-19	Suburban 1500 (1/2 Ton) 4WD - c/ Z85 Increased Capacity Chassis - Exc. Modelos c/ Z95 Magnetic Ride Control	0"	RS999830 <sup>XL</sup>	-	-	-	RS55830 <sup>X</sup>	-
2007-14	Suburban (1/2 Ton) 4WD - Exc. Susp. Electrónica y Modelos c/ ZW7 Nivomat	2"	-	-	-	-	RS55785 <sup>X</sup>	RS55262 <sup>X</sup>



AÑO	APLICACIÓN	ALTURA	RS9000XL		RS7000MT		RS5000/RS500X	
			DELANTERO	TRASERO	DELANTERO	TRASERO	DELANTERO	TRASERO
<b>CHEVROLET (CONT.)</b>								
2007-14	Suburban (1/2 Ton) 4WD - Exc. Modelos c/ Z55 o c/ ZW7 Nivomat	E.O.	RS999784 <sup>XL</sup>	RS999262 <sup>XL</sup>	-	RS7262	-	RS55262 <sup>X</sup>
2000-06	Suburban (1/2 Ton) 4WD - Exc. Modelos c/ Z55 o c/ ZW7 Nivomat	5 - 6"	RS999057 <sup>XL</sup>	RS999058 <sup>XL</sup>	-	-	-	-
2000-06	Suburban (1/2 Ton) 4WD - Exc. Modelos c/ Z55 o c/ ZW7 Nivomat	E.O.	RS999265 <sup>XL</sup>	RS999262 <sup>XL</sup>	-	-	RS55265 <sup>X</sup>	RS55262 <sup>X</sup>
1992-99	Suburban (1/2 Ton) 4WD	5 - 6"	RS999059 <sup>XL</sup>	RS999060 <sup>XL</sup>	-	-	-	-
1992-99	Suburban (1/2 Ton) 4WD	0 - 1"	RS999150 <sup>XL 148</sup>	RS999124 <sup>XL</sup>	RS7150 <sup>148</sup>	-	RS55150 <sup>X</sup>	RS55124 <sup>X</sup>
2007-14	Suburban (3/4 Ton) 4WD - Exc. c/ Z55 Autoride o c/ Paq. QuadraSteer	5 - 6"	RS999055 <sup>XL</sup>	RS999056 <sup>XL</sup>	-	-	-	-
2000-14	Suburban (3/4 Ton) 4WD - Exc. c/ Z55 Autoride o c/ Paq. QuadraSteer	E.O.	RS999295 <sup>XL</sup>	RS999262 <sup>XL</sup>	-	-	RS5295	RS55262 <sup>X</sup>
2000-06	Suburban (3/4 Ton) 4WD - Exc. Autoride y Paquete QuadraSteer	E.O.	-	-	-	-	-	RS55297 <sup>X</sup>
2015-19	Suburban 1500 (1/2 Ton) 2WD - Exc. Modelos c/ Z95 Magnetic Ride Control o Z85 Increased Capacity Chassis	0"	RS999830 <sup>XL</sup>	RS999262 <sup>XL</sup>	-	RS7262	RS55830 <sup>X</sup>	RS55262 <sup>X</sup>
2015-19	Suburban 1500 (1/2 Ton) 2WD - c/ Z85 Increased Capacity Chassis - Exc. Modelos c/ Z95 Magnetic Ride Control	0"	RS999830 <sup>XL</sup>	-	-	-	RS55830 <sup>X</sup>	-
2007-14	Suburban (1/2 Ton) 2WD - Exc. Susp. Electrónica y Modelos c/ ZW7 Nivomat	2"	-	-	-	-	RS55785 <sup>X</sup>	RS55262 <sup>X</sup>
2007-14	Suburban (1/2 Ton) 2WD - Exc. Modelos c/ Z55 o c/ ZW7 Nivomat	E.O.	RS999784 <sup>XL</sup>	RS999262 <sup>XL</sup>	-	-	-	RS55262 <sup>X</sup>
2000-06	Suburban (1/2 Ton) 2WD - Exc. Modelos c/ Z55 o c/ ZW7 Nivomat	E.O.	RS999265 <sup>XL</sup>	RS999262 <sup>XL</sup>	-	-	RS55265 <sup>X</sup>	RS55262 <sup>X</sup>
1992-99	Suburban (1/2 Ton) 2WD c/ RS6267	4"	-	-	-	-	RS55128 <sup>X</sup>	-
2007-14	Suburban (3/4 Ton) 2WD - c/ Barra de Torsión Delantera - Exc. c/ Z55 Autoride o c/ Paq. QuadraSteer	E.O.	RS999295 <sup>XL</sup>	RS999262 <sup>XL</sup>	-	-	RS5295	RS55262 <sup>X</sup>
2000-06	Suburban (3/4 Ton) 2WD - Exc. Modelos c/ Z55 o c/ ZW7 Nivomat	E.O.	RS999295 <sup>XL</sup>	RS999262 <sup>XL</sup>	-	-	RS5295	RS55262 <sup>X</sup>
2015-19	Tahoe 4WD - Exc. Modelos c/ Z95 Magnetic Ride Control o Z85 Increased Capacity Chassis	0"	RS999830 <sup>XL</sup>	RS999262 <sup>XL</sup>	-	RS7262	RS55830 <sup>X</sup>	RS55262 <sup>X</sup>
2015-19	Tahoe 4WD - c/ Z85 Increased Capacity Chassis - Exc. Modelos c/ Z95 Magnetic Ride Control	0"	RS999830 <sup>XL</sup>	-	-	-	RS55830 <sup>X</sup>	-
2007-14	Tahoe 4WD - Exc. Modelos c/ Z55, Z95	2"	-	-	-	-	RS55785 <sup>X</sup>	RS55262 <sup>X</sup>
2007-14	Tahoe 4WD - Exc. c/ Susp. Elect., Nivomat o Patrulla	E.O.	RS999784 <sup>XL</sup>	RS999262 <sup>XL</sup>	-	-	-	RS55262 <sup>X</sup>
2000-06	Tahoe y Sonora 4WD - Exc. Modelos c/ Z55, ZW7 Nivomat y AWD	5 - 6"	RS999057 <sup>XL</sup>	RS999058 <sup>XL</sup>	-	-	-	-
2000-06	Tahoe y Sonora 4WD - Exc. Modelos c/ Z55, ZW7 Nivomat	E.O.	RS999265 <sup>XL</sup>	RS999262 <sup>XL</sup>	-	-	RS55265 <sup>X</sup>	RS55262 <sup>X</sup>
1995-99	Tahoe y Sonora 4WD 2 Puertas y 4 Puertas	5 - 6"	RS999059 <sup>XL</sup>	RS999060 <sup>XL</sup>	-	-	-	-
1995-99	Tahoe y Sonora 4WD	0 - 1"	RS999150 <sup>XL</sup>	RS999124 <sup>XL</sup>	RS7150	-	RS55150 <sup>X</sup>	RS55124 <sup>X</sup>
2015-19	Tahoe 2WD - Exc. Modelos c/ Z95 Magnetic Ride Control o Z85 Increased Capacity Chassis	0"	RS999830	RS999262	-	RS7262	RS55830 <sup>X</sup>	RS55262 <sup>X</sup>
2015-19	Tahoe 2WD - c/ Z85 Increased Capacity Chassis - Exc. Modelos c/ Z95 Magnetic Ride Control	0"	RS999830	-	-	-	RS55830 <sup>X</sup>	-
2007-14	Tahoe 4WD - Exc. Modelos c/ Z55, Z95	2"	-	-	-	-	RS55785 <sup>X</sup>	RS55262 <sup>X</sup>
2007-14	Tahoe 2WD - Exc. Modelos c/ Z55 o c/ ZW7 Nivomat	E.O.	RS999784 <sup>XL</sup>	RS999262 <sup>XL</sup>	-	-	-	RS55262 <sup>X</sup>
2000-06	Tahoe y Sonora 2WD - Exc. Modelos c/ Z55 o c/ ZW7 Nivomat	E.O.	RS999265 <sup>XL</sup>	-	-	-	RS55265 <sup>X</sup>	RS55262 <sup>X</sup>
1995-99	Tahoe y Sonora 2WD 2 Puertas	0 - 1"	RS999166 <sup>XL 24</sup>	RS999124 <sup>XL</sup>	-	-	-	RS55124 <sup>X</sup>
1995-99	Tahoe y Sonora 2WD 4 Puertas	0 - 1"	RS999166 <sup>XL 24</sup>	-	-	-	-	-

AÑO	APLICACIÓN	ALTURA	RS9000XL		RS7000MT		RS5000/RS500X	
			DELANTERO	TRASERO	DELANTERO	TRASERO	DELANTERO	TRASERO

CHEVROLET Amortiguador de dirección Rancho						RS7000MT/RS5000			
						Tipo	Kit	Amortiguador	Soporte
2002-07	Avalanche 4x2 y 4x4 2500					Sencillo	-	RS5407	RS5548
2002-07	Avalanche 2500 4x2 y 4x4					Sencillo	-	-	RS5548
1995-00	Blazer 4x4 c/ Amortiguador de Dirección de Equipo Original (Utiliza Monturas de E.O.)					Sencillo	-	RS5401	-
2005-08	Pickup Silverado 4x2 1500HD Clasico					Sencillo	-	-	RS5548
2005-07	Pickup Silverado 4x4 1500HD					Sencillo	-	RS5407	RS5548
2005-07	Pickup Silverado 4x4 1500HD					Sencillo	-	-	RS5548
2001-03	Pickup Silverado 4x2 y 4x4 1500HD - Doble Cabina					Sencillo	-	RS5407	RS5548
2001-03	Pickup Silverado 4x2 y 4x4 1500HD - Doble Cabina					Sencillo	-	-	RS5548
1988-98	Pickup Silverado 4x4 1500 - Inc. Z71 c/ Amort. de Dirección de Equipo Original (Utiliza Monturas de E.O.)					Sencillo	-	RS5401	-
2005-08	Pickup Silverado 4x2 1500HD Doble Cabina					Sencillo	-	RS5407	RS5548
2001-08	Pickup Silverado 4x4 2500HD c/ 9,200 lbs de PBV					Sencillo	-	RS5407	RS5548
2001-08	Pickup Silverado 2500HD 4x2 y 4x4 c/ 9,200 lbs. de PBV (Sin soporte de E.O. para amortiguador de dirección)					Sencillo	-	-	RS5548
1988-00	Pickup Silverado 4x4 2500 y 3500 c/ Amort. de Dirección de Equipo Original (Utiliza Monturas de E.O.)					Sencillo	-	RS5401	-
1999-04	Pickup Silverado 2500 4x4 h/ 8,600 lbs. de PBV					Sencillo	-	-	RS5548
2000-02	Suburban 4x4 h/ 8,600 lbs. de PBV					Sencillo	-	-	RS5548
1992-97	Suburban c/ Amortiguador de Dirección de Equipo Original (Utiliza Monturas de E.O.)					Sencillo	RS97265	RS5401	-

DODGE									
2011-15	Durango 4WD	E.O.	-	-	-	-	-	RS55842 <sup>x</sup>	-
2004-09	Durango 4WD	E.O.	-	-	-	-	-	-	-
2000-03	Durango 4WD	3"	-	-	-	-	-	-	RS55010 <sup>x</sup>
1998-03	Durango 4WD	E.O.	RS999029 <sup>XL</sup>	RS999248 <sup>XL</sup>	-	-	-	RS55029 <sup>x</sup>	RS55248 <sup>x</sup>
2004-09	Durango 2WD	E.O.	-	-	-	-	-	-	-
1999-03	Durango 2WD	E.O.	-	-	-	-	-	RS55609 <sup>x</sup>	RS55147 <sup>x</sup>
2007-11	Nitro - Todos	E.O.	RS999764 <sup>XL</sup>	RS999284 <sup>XL</sup>	-	-	-	RS5764	RS55284 <sup>x</sup>
2013-18	Ram 1500 (1/2 Ton) 4WD c/ RS66402B; Exc. Susp. De Aire	4"	-	-	-	-	-	RS55810 <sup>x</sup>	RS55369 <sup>x</sup>
2009-18	Ram 1500 (1/2 Ton) 4WD - Exc. Susp. De Aire	E.O.	RS999808 <sup>XL</sup>	RS999367 <sup>XL</sup>	-	-	-	-	-
2009-11	Ram 1500 (1/2 Ton) 4WD c/ RS6587B	4"	-	-	-	-	-	RS55810 <sup>x</sup>	RS55369 <sup>x</sup>
2009-18	Ram 1500 (1/2 Ton) 4WD - Exc. AWD	E.O.	RS999808 <sup>XL</sup>	RS999367 <sup>XL</sup>	-	-	-	-	-
2006-08	Ram 1500 (1/2 Ton) 4WD - Exc. AWD y Mega Cab	E.O.	RS999788 <sup>XL</sup>	RS999274 <sup>XL</sup>	-	-	-	RS5788	RS55274 <sup>x</sup>
			-	-	-	-	-	-	RS55274 <sup>x</sup>
2006-08	Ram 1500 (1/2 Ton) 4WD Mega Cab	E.O.	RS999221 <sup>XL</sup>	RS999269 <sup>XL</sup>	-	-	-	-	-
2002-05	Ram 1500 (1/2 Ton) 4WD - Exc. AWD	5 - 6"	RS999280 <sup>XL</sup>	RS999056 <sup>XL</sup>	-	-	-	-	-
2002-05	Ram 1500 (1/2 Ton) 4WD - Exc. AWD	4"	RS999283 <sup>XL</sup>	RS999297 <sup>XL</sup>	-	-	-	RS55283 <sup>x</sup>	RS55297 <sup>x</sup>
2002-05	Ram 1500 (1/2 Ton) 4WD - Exc. AWD	1 1/2"	-	-	-	-	-	RS55373 <sup>x</sup>	-
2002-05	Ram 1500 (1/2 Ton) 4WD - Exc. AWD	E.O.	RS999282 <sup>XL</sup>	RS999274 <sup>XL</sup>	-	-	-	RS55282 <sup>x</sup>	RS55274 <sup>x</sup>
2000-01	Ram 1500 (1/2 Ton) 4WD c/ Paquete Off-Road	E.O.	RS999221 <sup>XL</sup>	RS999198 <sup>XL</sup>	-	-	RS7198	-	RS55198 <sup>x</sup>
1994-01	Ram 1500 (1/2 Ton) 4WD - Exc. Paquete Off-Road	E.O.	RS999197 <sup>XL</sup>	RS999262 <sup>XL</sup>	-	-	-	-	RS55262 <sup>x</sup>
1994-01	Ram 1500 (1/2 Ton) 4WD - c/ Paquete Off-Road	E.O.	-	-	-	-	-	-	RS55198 <sup>x</sup>
1994-01	Ram 1500 (1/2 Ton) 4WD - c/ RS6565B o RS6445 c/ amortiguadores dobles - Exc. Paquete Off-Road	E.O.	-	-	-	-	-	-	RS55198 <sup>x</sup>
1994-01	Ram 1500 (1/2 Ton) 4WD - c/ RS6475B o RS6575 - Exc. Paquete Off-Road	E.O.	-	-	-	-	-	-	RS55198 <sup>x</sup>
2009-14	Ram 1500 (1/2 Ton) 2WD - Exc. Mega Cab	E.O.	RS999368 <sup>XL</sup>	RS999367 <sup>XL</sup>	-	-	-	-	-
2009-18	Ram 1500 (1/2 Ton) 2WD - Exc. Paquete Tradesman HD	E.O.	RS999368 <sup>XL</sup>	RS999367 <sup>XL</sup>	-	-	-	-	-
2011-12	Ram 1500 (1/2 Ton) 2WD - c/ Paquete Tradesman HD	E.O.	RS999279 <sup>XL</sup>	RS999269 <sup>XL</sup>	-	-	-	-	RS55269 <sup>x</sup>





AÑO	APLICACIÓN	ALTURA	RS9000XL		RS7000MT		RS5000/RS500X	
			DELANTERO	TRASERO	DELANTERO	TRASERO	DELANTERO	TRASERO
<b>DODGE (CONT.)</b>								
2002-08	Ram 1500 (1/2 Ton) 2WD - Exc. Mega Cab	E.O.	RS999281 <sup>XL</sup>	RS999274 <sup>XL</sup>	-	-	RS55281 <sup>X</sup>	RS55274 <sup>X</sup>
1994-01	Ram 1500 (1/2 Ton) 2WD	E.O.	RS999195 <sup>XL</sup>	RS999262 <sup>XL</sup>	-	-	-	RS55262 <sup>X</sup>
1972-93	D100, D150 (1/2 Ton) 2WD	0 - 2"	-	RS999116 <sup>XL</sup>	-	-	-	RS55116 <sup>X</sup>
2014-19	Ram 2500 (3/4 Ton) 4WD c/ RS66453B o RS66542B	4 - 5"	RS999048 <sup>XL</sup>	RS999048 <sup>XL</sup>	-	-	RS55048 <sup>X</sup>	RS55048 <sup>X</sup>
2014	Ram 2500 (3/4 Ton) 4WD c/ RS66453B o RS66542B	3"	-	-	-	-	-	RS55048 <sup>X</sup>
2003-13	Ram 2500 (3/4 Ton) 4WD	E.O.	RS999221 <sup>XL</sup>	RS999269 <sup>XL</sup>	-	-	-	-
2005-13	Ram 2500 (3/4 Ton) 4WD Power Wagon	E.O.	RS999044 <sup>XL</sup>	RS999058 <sup>XL</sup>	-	-	-	-
2003-10	Ram 2500 (3/4 Ton) 4WD - Exc. Transmisión Manual o AWD	2"	-	-	-	-	-	RS55269 <sup>X</sup>
2003-10	Ram 2500 (3/4 Ton) 4WD c/ RS6576 - Exc. AWD	2"	-	-	-	-	-	RS55269 <sup>X</sup>
2003-10	Ram 2500 (3/4 Ton) 4WD - Exc. Power Wagon	E.O.	-	-	-	-	-	RS55269 <sup>X</sup>
1994-02	Ram 3500 (3/4 Ton) 4WD c/ 8,800 lb. de PBV	E.O.	RS999221 <sup>XL</sup>	RS999274 <sup>XL</sup>	-	-	-	RS55274 <sup>X</sup>
1994-96	Ram 2500 (3/4 Ton) 4WD - c/ 7,700 lb. de PBV	E.O.	RS999197 <sup>XL</sup>	RS999262 <sup>XL</sup>	-	-	-	RS55262 <sup>X</sup>
1994-96	Ram 2500 (3/4 Ton) 4WD - c/ 7,700 lb. PBV c/ RS6446 y Amortiguadores Dobles	2"	-	-	-	-	-	RS55274 <sup>X</sup>
1994-96	Ram 2500 (3/4 Ton) 4WD - c/ 7,700 lb. PBV c/ RS6476	2"	-	-	-	-	-	RS55198 <sup>X</sup>
2014-19	Ram 2500 (3/4 Ton) 2WD	E.O.	RS999197 <sup>XL</sup>	RS999044 <sup>XL</sup>	-	-	-	RS55044 <sup>X</sup>
2003-13	Ram 2500 (3/4 Ton) 2WD	E.O.	RS999279 <sup>XL</sup>	RS999269 <sup>XL</sup>	-	-	-	RS55269 <sup>X</sup>
1994-02	Ram 2500 (3/4 Ton) 2WD	E.O.	RS999195 <sup>XL</sup>	RS999262 <sup>XL</sup>	-	-	-	RS55262 <sup>X</sup>
2003-12	Ram 3500 (1 Ton) 4WD	E.O.	RS999221 <sup>XL</sup>	RS999269 <sup>XL</sup>	-	-	-	RS55269 <sup>X</sup>
1994-02	Ram 3500 (1 Ton) 4WD	E.O.	RS999221 <sup>XL</sup>	RS999274 <sup>XL</sup>	-	-	-	RS55274 <sup>X</sup>
2003-12	Ram 3500 (1 Ton) 2WD	E.O.	RS999279 <sup>XL</sup>	RS999269 <sup>XL</sup>	-	-	-	-
1994-02	Ram 3500 (1 Ton) 2WD c/ Suspensión Delantera Independiente	E.O.	RS999195 <sup>XL</sup>	RS999274 <sup>XL</sup>	-	-	-	RS55274 <sup>X</sup>
1994-02	Ram 3500 (1 Ton) 2WD c/ Eje Delantero Sólido	E.O.	RS999221 <sup>XL</sup>	RS999274 <sup>XL</sup>	-	-	-	RS55274 <sup>X</sup>
1972-93	D300, D350 (1 Ton) 2WD	0 - 2"	-	RS999116 <sup>XL</sup>	-	-	-	RS55116 <sup>X</sup>
2010-11	Dakota 4WD	E.O.	-	-	-	-	-	RS55315 <sup>X</sup>
2005-09	Dakota 4WD	E.O.	-	-	-	-	-	RS55315 <sup>X</sup>
2000-04	Dakota 4WD	3"	-	-	-	-	-	RS55010 <sup>X</sup>
1997-04	Dakota 4WD - Inc. 4 Puertas	E.O.	RS999029 <sup>XL</sup>	RS999248 <sup>XL</sup>	-	-	-	RS55248 <sup>X</sup>
1987-96	Dakota 4WD	0 - 1"	-	RS999124 <sup>XL</sup>	-	-	-	RS55124 <sup>X</sup>
2010-11	Dakota 2WD	E.O.	-	-	-	-	-	RS55315 <sup>X</sup>
2005-09	Dakota 2WD	E.O.	-	-	-	-	-	RS55315 <sup>X</sup>
1997-04	Dakota 2WD	E.O.	-	RS999147 <sup>XL</sup>	-	-	RS55609 <sup>X</sup>	RS55147 <sup>X</sup>
1987-96	Dakota 2WD	0 - 1"	-	-	-	-	RS5602 <sup>10</sup>	-
1970-03	Van Ram (1/2 Ton) Modelos B100, B150, B1500	E.O.	-	RS999113 <sup>XL</sup>	-	RS7113	-	RS55113 <sup>X</sup>
1970-03	Van Ram (3/4 Ton) Modelos B200, B250, B2500	E.O.	-	RS999113 <sup>XL</sup>	-	RS7113	-	RS55113 <sup>X</sup>
1970-03	Van Ram (1 Ton) Modelos B300, B350, B3500 - Exc. c/ 9,000 lb. de PBV o 4,000lb. Eje Delantero	E.O.	-	RS999113 <sup>XL</sup> 23	-	RS7113 23	-	RS55113 <sup>X</sup> 23

		RS7000MT/RS5000	
DODGE Amortiguador de dirección Rancho	Tipo	Kit	Sin Soporte Soporte
2006-08 Pickup 4x4 1500 Ram - Mega Cab	Doble	RS98511	RS5412 -
2006-08 Pickup 4x4 1500 Ram - Mega Cab	Doble	RS98511	- -
1994-99 Pickup 4x4 1500, 2500 y 3500 Ram c/ Amortiguador de Dirección de Equipo Original (Utiliza Monturas de E.O.)	Sencillo	-	RS5404 -
2003-08 Pickup 4x4 2500 Ram - Mega Cab	Doble	RS98511	RS5412 -
2003-08 Ram 2500 4x4	Doble	RS98511	- -
2003-08 Pickup 4x4 2500 Ram c/ Amortiguador de Dirección de Equipo Original 52106909AB, AC y AD	Sencillo	-	RS5412 -
2000-08 Pickup 4x4 3500 Ram c/ Amortiguador de Dirección de Equipo Original 52106909AB, AC y AD	Sencillo	-	RS5412 -
1960-93 Pickup 4x4 W100, W150, W300 y W350	Doble	RS98501 <sup>64</sup>	RS5402 -

AÑO	APLICACIÓN	ALTURA	RS9000XL		RS7000MT		RS5000/RS500X	
			DELANTERO	TRASERO	DELANTERO	TRASERO	DELANTERO	TRASERO
<b>FORD</b>								
1994-96	Bronco 4WD	E.O.						
	Después de Eje Delantero		RS999029 <sup>XL</sup>	-	-	-	RS55029 <sup>X</sup>	-
	Delante de Eje Delantero		RS999117 <sup>XL</sup>	-	-	-	RS55117 <sup>X</sup>	-
	Trasero		-	RS999116 <sup>XL 22</sup>	-	-	-	RS55116 <sup>X 22</sup>
1980-96	Bronco 4WD	E.O.	RS999029 <sup>XL</sup>	RS999118 <sup>XL 22</sup>	-	RS7118 22	RS55029 <sup>X</sup>	RS55118 <sup>X 22</sup>
2000-05	Excursion 4WD	4"	RS999264 <sup>XL</sup>	RS999275	-	-	RS55264 <sup>X</sup>	-
2000-05	Excursion 4WD	E.O.	RS999267 <sup>XL</sup>	RS999266 <sup>XL</sup>	-	-	RS5267 RS55267 <sup>X</sup>	-
2000-05	Excursion 2WD	E.O.	RS999272 <sup>XL</sup>	RS999278 <sup>XL</sup>	-	-	RS55272 <sup>X</sup>	-
2003-06	Expedition 4WD	E.O.	-	-	-	-	RS5818	-
1997-02	Expedition 4WD - Exc. c/ Susp. de Aire	E.O.	RS999233 <sup>XL</sup>	-	-	-	RS55233 <sup>X</sup>	-
2003-06	Expedition 2WD	E.O.	-	-	-	-	RS5818	-
1997-02	Expedition 2WD - Exc. c/ Susp. de Aire	E.O.	RS999235 <sup>XL</sup>	RS999118 <sup>XL</sup>	-	RS7118	-	RS55118 <sup>X</sup>
2001-06	Explorer Sport Trac 4WD	E.O.	RS999229 <sup>XL</sup>	RS999185 <sup>XL</sup>	-	-	RS55229 <sup>X</sup>	RS55185 <sup>X</sup>
2001-06	Explorer Sport Trac 2WD	E.O.	RS999229 <sup>XL</sup>	RS999185 <sup>XL</sup>	-	-	RS55229 <sup>X</sup>	RS55185 <sup>X</sup>
2001-03	Explorer Sport 4WD	E.O.	RS999229 <sup>XL</sup>	RS999185 <sup>XL</sup>	-	-	RS55229 <sup>X</sup>	RS55185 <sup>X</sup>
2001-03	Explorer Sport 2WD	E.O.	RS999229 <sup>XL</sup>	RS999185 <sup>XL</sup>	-	-	RS55229 <sup>X</sup>	RS55185 <sup>X</sup>
1995-01	Explorer 4WD	E.O.	RS999229 <sup>XL</sup>	RS999185 <sup>XL</sup>	-	-	RS55229 <sup>X</sup>	RS55185 <sup>X</sup>
1990- Nov 94	Explorer 4WD	0 - 1 1/2"	RS999039 <sup>XL</sup>	RS999185 <sup>XL</sup>	-	-	-	RS55185 <sup>X</sup>
1995-01	Explorer 2WD	E.O.	RS999229 <sup>XL</sup>	RS999185 <sup>XL</sup>	-	-	RS55229 <sup>X</sup>	RS55185 <sup>X</sup>
1990- Nov 94	Explorer 2WD	0 - 1 1/2"	RS999039 <sup>XL</sup>	RS999185 <sup>XL</sup>	-	-	-	RS55185 <sup>X</sup>
2021-22	F-150, Lobo (1/2 Ton) 4WD - c/ Paq. Heavy Duty Payload y Off-Road Exc. Tremor, Raptor, Limited y Modelos c/ Amortiguación controlada continuamente	E.O.	-	RS999149 <sup>XL</sup>	-	-	-	RS55149 <sup>X</sup>
2015-20	F-150, Lobo (1/2 Ton) 4WD - Exc. Raptor	E.O.	RS999836 <sup>XL</sup>	RS999316 <sup>XL</sup>	-	RS7316	RS55836 <sup>X</sup>	RS55316 <sup>X</sup>
2017-18	F-150, Lobo (1/2 Ton) 4WD c/ RS66506B - Exc. AWD, SVT Raptor	6"	-	RS999287	-	-	RS55839 <sup>X</sup>	RS55287 <sup>X</sup> RS5287
2015-18	F-150, Lobo (1/2 Ton) 4WD c/ RS66505B - Exc. AWD, SVT Raptor	E.O.	RS999838 <sup>XL</sup>	RS999287	-	-	RS55838 <sup>X</sup>	RS55287 <sup>X</sup> RS5287
2014-18	F-150, Lobo (1/2 Ton) 4WD	E.O.	RS999836 <sup>XL</sup>	-	-	-	RS55836 <sup>X</sup>	RS55316 <sup>X</sup>
2009-11	F-150, Lobo (1/2 Ton) 4WD c/ RS6519B	4"	RS999806 <sup>XL</sup>	RS999287 <sup>XL</sup>	-	-	RS55806 <sup>X</sup>	RS5287
2009-11	F-150, Lobo (1/2 Ton) 4WD	E.O.	RS999804 <sup>XL</sup>	RS999384 <sup>XL</sup>	-	-	-	RS55384 <sup>X</sup>
2004-08	F-150, Lobo (1/2 Ton) 4WD	E.O.	-	RS999286 <sup>XL</sup>	-	-	RS55767 <sup>X</sup>	-
2004	F-150, Lobo (1/2 Ton) 4WD c/ RS6488 - Exc. c/ 7,700lbs. de PBV	4"	RS999237 <sup>XL</sup>	RS999238 <sup>XL</sup>	-	-	RS55237 <sup>X</sup>	RS55238 <sup>X</sup>
2001-03	F-150, Lobo (1/2 Ton) 4WD Super Crew	E.O.	RS999233 <sup>XL</sup>	RS999234 <sup>XL</sup>	-	-	RS55233 <sup>X</sup>	RS55234 <sup>X</sup>
1997-04	F-150, Lobo (1/2 Ton) 4WD - c/ 7,700 lb. PBV	E.O.	RS999233 <sup>XL</sup>	-	-	-	RS55233 <sup>X</sup>	-
1997-04	F-150, Lobo (1/2 Ton) 4WD - Exc. c/ 7,700 lb. PBV	E.O.	RS999233 <sup>XL</sup>	RS999234 <sup>XL</sup>	-	-	RS55233 <sup>X</sup>	RS55234 <sup>X</sup>
1981-96	F-100, F-150 (1/2 Ton) 4WD	4"	RS999117 <sup>XL</sup>	RS999112 <sup>XL 22</sup>	-	-	RS55117 <sup>X</sup>	RS55112 <sup>X 22</sup>
1980-96	F-100, F-150 (1/2 Ton) 4WD c/ RS6440	E.O.	RS999029 <sup>XL</sup>	RS999116 <sup>XL 22</sup>	-	-	RS55029 <sup>X</sup>	RS55116 <sup>X 22</sup>
1980-96	F-100, F-150 (1/2 Ton) 4WD c/ Amort. Quad	E.O.						
	Después de Eje Delantero		RS999029 <sup>XL</sup>	-	-	-	RS55029 <sup>X</sup>	-
	Delante de Eje Delantero		RS999117 <sup>XL</sup>	-	-	-	RS55117 <sup>X</sup>	-
	Trasero		-	RS999116 <sup>XL 22</sup>	-	-	-	RS55116 <sup>X 22</sup>
2021-22	F-150, Lobo (1/2 Ton) 2WD - c/ Paq. Heavy Duty Payload y Premium Exc. Limited y Modelos c/ Amortiguación controlada continuamente	E.O.	-	RS999149 <sup>XL</sup>	-	-	-	RS55149 <sup>X</sup>



AÑO	APLICACIÓN	ALTURA	RS9000XL		RS7000MT		RS5000/RS500X	
			DELANTERO	TRASERO	DELANTERO	TRASERO	DELANTERO	TRASERO
<b>FORD (CONT.)</b>								
2015-20	F-150, Lobo (1/2 Ton) 2WD	E.O.	-	RS999149 <sup>XL</sup>	-	-	-	RS55149 <sup>X</sup>
2015-18	F-150, Lobo (1/2 Ton) 2WD c/ Sistema Rancho RS66501B	6"	-	-	-	-	RS55839 <sup>X</sup>	RS55287 <sup>X</sup> RS5287
2015-18	F-150, Lobo (1/2 Ton) 2WD c/ Sistema Rancho RS66500B	4 1/2"	-	-	-	-	RS55838 <sup>X</sup>	RS55287 <sup>X</sup> RS5287
2014	F-150, Lobo (1/2 Ton) 2WD	E.O.	-	RS999149 <sup>XL</sup>	-	-	RS55834 <sup>X</sup>	RS55149 <sup>X</sup>
2009-13	F-150, Lobo (1/2 Ton) 2WD	E.O.	RS999803 <sup>XL</sup>	RS999286 <sup>XL</sup>	-	-	RS55803 <sup>X</sup>	-
2004-08	F-150, Lobo (1/2 Ton) 2WD	E.O.	RS999774 <sup>XL</sup>	RS999285 <sup>XL</sup>	-	-	-	-
1997-03	F-150, Lobo (1/2 Ton) 2WD - c/ 7,700 PBV	E.O.	RS999235 <sup>XL</sup>	RS999236 <sup>XL</sup>	-	-	-	RS55236 <sup>X</sup>
1985-96	F-100, F-150, (1/2 Ton) 2WD	E.O.	RS999029 <sup>XL</sup>	RS999116 <sup>XL 22</sup>	-	-	RS55029 <sup>X</sup>	RS55118 <sup>X 22</sup>
1980-96	F-100, F-150, (1/2 Ton) 2WD - Exc. Super Cab	E.O.	-	-	-	-	-	RS55118 <sup>X</sup>
2017-21	F-250 Superduty (3/4 Ton) 4WD	2 1/2"	RS999043 <sup>XL</sup>	RS999047A <sup>XL</sup>	-	-	-	RS55047A <sup>X</sup>
2017-21	F-250 Superduty (3/4 Ton) 4WD	E.O.	RS999042 <sup>XL</sup>	RS999047A <sup>XL</sup>	-	-	RS55042 <sup>X</sup>	RS55047A <sup>X</sup>
2017-20	F-250 Superduty (3/4 Ton) 4WD c/ RS66552B	5"	-	RS999036A <sup>XL</sup>	-	-	-	RS55036A <sup>X</sup>
2011-16	F-250 Superduty (3/4 Ton) 4WD Diesel c/ RS6524B o RS66551B	E.O.	-	-	-	-	-	RS55261 <sup>X</sup>
2011-16	F-250 Superduty (3/4 Ton) 4WD Diesel c/ RS6525B	E.O.	-	-	-	-	-	RS55261 <sup>X</sup>
2005-18	F-250 Superduty (3/4 Ton) 4WD - Exc. Chasis Cab	E.O.	RS999042 <sup>XL</sup>	RS999254 <sup>XL</sup>	RS7042	RS7254	RS55042 <sup>X</sup>	RS55254 <sup>X</sup>
2005-18	F-250 Superduty (3/4 Ton) 4WD	E.O.	-	-	-	-	-	RS55045 <sup>X</sup>
2005-18	F-250 Superduty (3/4 Ton) 4WD - Exc. Chasis Cab o AWD	5 - 6"	RS999048 <sup>XL</sup>	RS999045 <sup>XL</sup>	-	-	RS55048 <sup>X</sup>	-
2005-16	F-250 Superduty (3/4 Ton) 4WD c/ Sistema Rancho RS6510 o RS6515 Exc. Chasis Cab	2 1/2"	RS999043 <sup>XL</sup>	RS999254 <sup>XL</sup>	-	RS7254	-	RS55254 <sup>X</sup>
2005-10	F-250 Superduty (3/4 Ton) 4WD c/ RS6511, RS6511B, RS6514 o RS6514B Exc. Chasis Cab y Doble Rodado Trasero	4"	RS999044 <sup>XL</sup>	RS999261 <sup>XL</sup>	-	-	RS5044	RS55261 <sup>X</sup>
1999-04	F-250 Superduty (3/4 Ton) 4WD - Exc. Chasis Cab o AWD	5 - 6"	RS999050 <sup>XL</sup>	RS999045 <sup>XL</sup>	-	-	-	RS55045 <sup>X</sup>
1999-04	F-250 Superduty (3/4 Ton) 4WD - Exc. Chasis Cab y Doble Rodado	4"	RS999264 <sup>XL</sup>	-	-	-	RS55264 <sup>X</sup>	-
1999-04	F-250 Superduty (3/4 Ton) 4WD - Exc. Chasis Cab y AWD	2 1/2"	RS999264 <sup>XL</sup>	-	-	-	RS55264 <sup>X</sup>	-
1999-04	F-250 Superduty (3/4 Ton) 4WD c/ RS6553B or RS6653B - Exc. Chasis Cab or AWD	E.O.	-	-	-	-	-	RS55261 <sup>X</sup>
1999-04	F-250 Superduty (3/4 Ton) 4WD - Exc. Chasis Cab o AWD	E.O.	-	-	-	-	-	RS55254 <sup>X</sup>
1999-04	F-250 Superduty (3/4 Ton) 4WD - Exc. Chasis Cab	E.O.	RS999267 <sup>XL</sup>	RS999273 <sup>XL</sup>	-	RS7254	RS5267 RS55267 <sup>X</sup>	RS55273 <sup>X</sup>
2005-15	F-250 Superduty (3/4 Ton) 2WD	E.O.	RS999272 <sup>XL</sup>	RS999046 <sup>XL</sup>	-	-	RS55272 <sup>X</sup>	RS55046 <sup>X</sup>
1999-04	F-250 Superduty (3/4 Ton) 2WD	E.O.	RS999272 <sup>XL</sup>	RS999273 <sup>XL</sup>	-	RS7254	RS55272 <sup>X</sup>	RS55273 <sup>X</sup>
1997-99	F-250 Superduty (3/4 Ton) 2WD	E.O.	RS999235 <sup>XL</sup>	-	-	-	-	-
1992-96	F-250 (3/4 Ton) 2WD	E.O.	RS999029 <sup>XL</sup>	RS999116 <sup>XL 22</sup>	-	-	RS55029 <sup>X</sup>	RS55116 <sup>X 22</sup>
2017-21	F-250 Superduty (3/4 Ton) 4WD	2 1/2"	RS999043 <sup>XL</sup>	RS999047A <sup>XL</sup>	-	-	RS55043 <sup>X</sup>	RS55047A <sup>X</sup>
2017-21	F-250 Superduty (3/4 Ton) 4WD - Exc. Chasis	E.O.	RS999042 <sup>XL</sup>	RS999047A <sup>XL</sup>	-	-	RS55042 <sup>X</sup>	RS55047A <sup>X</sup>
2017-20	F-350 Superduty 4WD c/ RS66552B - Exc. Doble rodado	5"	-	RS999036A <sup>XL</sup>	-	-	-	RS55036A <sup>X</sup>
2011-16	F-350 Superduty (1 ton) 4WD Diesel c/ RS6524B or RS66551B	E.O.	-	-	-	-	-	RS55261 <sup>X</sup>
2011-16	F-350 Superduty (1 ton) 4WD Diesel c/ RS6525B -- Exc. Chasis Cab	E.O.	-	-	-	-	-	RS55047 <sup>X</sup> RS55254 <sup>X</sup>
	Rodado Tras. Sencillo							
2005-16	F-350 Superduty (1 ton) 4WD c/ Doble Rodado Tras. - Exc. Chasis Cab	E.O.	RS999042 <sup>XL</sup>	RS999254 <sup>XL</sup>	-	RS7254	RS55042 <sup>X</sup>	RS55254 <sup>X</sup>
	Doble Rodado Tras.							
2005-16	F-350 Superduty (1 ton) 4WD c/ Doble Rodado Tras. Chasis Cab	E.O.	RS999042 <sup>XL</sup>	RS999046 <sup>XL</sup>	-	-	RS55042 <sup>X</sup>	RS55046 <sup>X</sup>
2005-16	F-350 Superduty (1 ton) 4WD c/ Rodado Tras. Sencillo - Exc. Chasis Cab	E.O.	RS999042 <sup>XL</sup>	RS999047 <sup>XL</sup>	-	RS7254	RS55042 <sup>X</sup>	RS55047 <sup>X</sup>

AÑO	APLICACIÓN	ALTURA	RS9000XL		RS7000MT		RS5000/RS500X	
			DELANTERO	TRASERO	DELANTERO	TRASERO	DELANTERO	TRASERO
<b>FORD (CONT.)</b>								
2005-10	F-350 Superduty (1 Ton) 4WD c/ RS6511, RS6511B, RS6514 o RS6514B Exc. Chasis Cab	E.O.	-	-	-	-	-	RS55045 <sup>X</sup>
2005-10	F-350 Superduty (1 ton) 4WD c/ Rodado Tras. Sencillo - Exc. Chasis Cab	E.O.	-	-	-	-	-	RS55047 <sup>X</sup>
1999-04	F-350 Superduty (1 Ton) 4WD	4"	RS999264 <sup>XL</sup>	-	-	-	RS55264 <sup>X</sup>	-
1999-04	F-350 Superduty (1 Ton) 4WD	2 1/2"	RS999264 <sup>XL</sup>	-	-	-	RS55264 <sup>X</sup>	-
1999-04	F-350 Superduty (1 ton) 4WD - Exc. Chasis Cab or Doble Rodado Tras.	E.O.	-	-	-	-	-	RS55254 <sup>X</sup>
1999-04	F-350 Superduty (1 ton) 4WD c/ Rodado Tras. Sencillo - Exc. Chasis Cab	E.O.	-	-	-	-	-	RS55254 <sup>X</sup>
1999-04	F-350 Superduty (1 ton) 4WD c/ RS6553B or RS6653B - Exc. Chasis Cab or Doble Rodado Tras.	E.O.	-	-	-	-	-	RS55261 <sup>X</sup>
2005-15	F-350 Superduty (1 Ton) 2WD - Exc. Chasis Cab	E.O.	RS999272 <sup>XL</sup>	RS999046 <sup>XL</sup>	-	-	RS55272 <sup>X</sup>	RS55046 <sup>X</sup>
2005-15	F-350 Superduty (1 Ton) 2WD Chasis Cab	E.O.	RS999272 <sup>XL</sup>	-	-	-	RS55272 <sup>X</sup>	-
1999-04	F-350 Superduty (1 Ton) 2WD - Exc. Chasis Cab	E.O.	RS999272 <sup>XL</sup>	RS999273 <sup>XL</sup>	-	RS7254	RS55272 <sup>X</sup>	RS55273 <sup>X</sup>
1980-98	F-350 (1 Ton) 2WD	E.O.	RS999029 <sup>XL</sup>	RS999118 <sup>XL</sup>	-	RS7118	RS55029 <sup>X</sup>	RS55118 <sup>X</sup>
1998-11	Ranger 4WD	E.O.	RS999229 <sup>XL</sup>	RS999126 <sup>XL</sup>	-	-	RS55029 <sup>X</sup>	RS55126 <sup>X</sup>
1983-92	Ranger 4WD	2 1/2"	-	-	-	-	-	RS55010 <sup>X</sup>
1998-11	Ranger 2WD - Inc. Edge	1 - 2 1/2"	-	-	-	-	RS55374 <sup>X</sup> <sub>313</sub>	RS55126 <sup>X</sup>
2001-11	Ranger 2WD c/ Suspensión Del. de Barra de Torsión	E.O.	RS999229 <sup>XL</sup>	RS999126 <sup>XL</sup>	-	-	RS55229 <sup>X</sup>	RS55126 <sup>X</sup>
1998-11	Ranger 2WD - Exc. Edge	E.O.	-	RS999194 <sup>XL</sup>	-	-	-	-
1983-92	Ranger 2WD	2 1/2"	-	-	-	-	-	RS55010 <sup>X</sup>
1999-04	F-450 2WD y 4WD Superduty	E.O.	RS999267 <sup>XL</sup>	RS999126 <sup>XL</sup>	-	-	RS5267 RS55267 <sup>X</sup>	RS55126 <sup>X</sup>
1999-04	F-550 2WD y 4WD Superduty	E.O.	RS999267 <sup>XL</sup>	RS999126 <sup>XL</sup>	-	-	RS5267 RS55267 <sup>X</sup>	RS55126 <sup>X</sup>
1975-91	Van Econoline, E-100, E-150 (1/2 Ton)	E.O.	RS999039 <sup>XL</sup>	RS999117 <sup>XL</sup>	-	-	-	RS55117 <sup>X</sup>
1975-91	Van Econoline, E-250 (3/4 Ton)	E.O.	RS999136 <sup>XL</sup>	RS999115 <sup>XL</sup>	-	-	RS55136 <sup>X</sup>	RS55115 <sup>X</sup>
1975-91	Van Econoline, E-350 (1 Ton)	E.O.	RS999136 <sup>XL</sup>	RS999115 <sup>XL</sup>	-	-	RS55136 <sup>X</sup>	RS55115 <sup>X</sup>

<b>GM</b>								
2014	Pickup (1/2 Ton) 4WD Sierra 1500 - Exc. Control de Manejo Electrónico ZX3 y AWD	E.O.	-	-	-	-	RS55830 <sup>X</sup>	-
1999-16	Pickup (1/2 Ton) 4WD Sierra 1500 - Exc. 1500HD, Control de Manejo Electrónico ZX3, Quadrateer, Autoride, c/ Susp. de Aire y AWD	E.O.	-	-	-	-	-	RS55198 <sup>X</sup>
2007-13	Pickup (1/2 Ton) 4WD Sierra 1500 - Exc. Control de Manejo Electrónico ZX3 y AWD	2"	-	-	-	-	RS55785 <sup>X</sup>	RS55198 <sup>X</sup>
2007-13	Pickup (1/2 Ton) 4WD Sierra 1500 - Exc. Control de Manejo Electrónico ZX3 y AWD	E.O.	RS999784 <sup>XL</sup>	RS999198 <sup>XL</sup>	-	RS7198	-	RS55198 <sup>X</sup>
2005-07	Pickup (1/2 Ton) 4WD Sierra 1500HD Crew Cab - Exc. c/ Susp. Elect.	5 - 6"	RS999055 <sup>XL</sup>	RS999056 <sup>XL</sup>	-	-	-	-
2005-07	Pickup (1/2 Ton) 4WD Sierra 1500HD Crew Cab - Exc. c/ Susp. Elect.	E.O.	RS999295 <sup>XL</sup>	RS999274 <sup>XL</sup>	-	-	RS5295	RS55274 <sup>X</sup>
1999-08	Pickup (1/2 Ton) 4WD Sierra 1500 Clásico - Exc. Control de Manejo Electrónico ZX3	E.O.	-	-	-	-	-	RS55297 <sup>X</sup>
1999-07	Pickup (1/2 Ton) 4WD Sierra 1500 Clásico	5 - 6"	RS999057 <sup>XL</sup>	RS999297 <sup>XL</sup>	-	-	-	-
1999-07	Pickup (1/2 Ton) 4WD Sierra 1500 Clásico Exc. 1500HD y c/ Susp. Elect.	E.O.	RS999265 <sup>XL</sup>	RS999198 <sup>XL</sup>	-	RS7198	RS55265 <sup>X</sup>	RS55198 <sup>X</sup>
1999-07	Pickup (1/2 Ton) 4WD Sierra 1500 Clásico c/ Susp. Del. de Barra de Torsión - Exc. Control de Manejo Electrónico ZX3	E.O.	-	-	-	-	RS55265 <sup>X</sup>	RS55198 <sup>X</sup>
2001-03	Pickup (1/2 Ton) 4WD Sierra 1500HD Crew Cab - Exc. c/ Susp. Elect.	5 - 6"	RS999055 <sup>XL</sup>	RS999056 <sup>XL</sup>	-	-	-	-
2001-03	Pickup (1/2 Ton) 4WD Sierra 1500HD Crew Cab - Exc. c/ Susp. Elect.	E.O.	RS999295 <sup>XL</sup>	RS999274 <sup>XL</sup>	-	-	RS5295	RS55274 <sup>X</sup>



AÑO	APLICACIÓN	ALTURA	RS9000XL		RS7000MT		RS5000/RS500X	
			DELANTERO	TRASERO	DELANTERO	TRASERO	DELANTERO	TRASERO
<b>GM (CONT.)</b>								
1988-98	Pickup (1/2 Ton) 4WD K-1500	5 - 6"	RS999059 <sup>XL</sup>	RS999060 <sup>XL</sup>	-	-	-	-
1988-98	Pickup (1/2 Ton) 4WD K-1500	E.O.	RS999 <sup>152XL</sup>	RS999190 <sup>XL</sup>	RS7150	RS7190	RS55150 <sup>X</sup>	RS55190 <sup>X</sup>
2015	Pickup (1/2 Ton) 2WD Sierra 1500 - Exc. Control de Manejo Electrónico ZX3 y AWD	E.O.	-	-	-	-	RS55830 <sup>X</sup>	-
2007-13	Pickup (1/2 Ton) 4WD Sierra 1500 - Exc. Control de Manejo Electrónico ZX3 y AWD	2"	-	-	-	-	RS55785 <sup>X</sup>	RS55198 <sup>X</sup>
2007-13	Pickup (1/2 Ton) 2WD Sierra 1500 - Exc. Control de Manejo Electrónico ZX3 y Quadrateer	E.O.	RS999784 <sup>XL</sup>	RS999198 <sup>XL</sup>	-	RS7198	-	RS55198 <sup>X</sup>
1999-13	Pickup (1/2 Ton) 2WD Sierra 1500 c/ Sistema RS6583 o RS6583B	4"	-	-	-	-	-	RS55269 <sup>X</sup>
1999-13	Pickup (1/2 Ton) 2WD Sierra 1500 c/ Transmisión Automática	4"	-	-	-	-	-	RS55269 <sup>X</sup>
2005-07	Pickup (1/2 Ton) 2WD Sierra 1500HD c/ 9,200lbs. de PBV	E.O.	RS999295 <sup>XL</sup>	RS999274 <sup>XL</sup>	-	-	RS5295	RS55274 <sup>X</sup>
2004-07	Pickup (1/2 Ton) 2WD Sierra 1500 c/ Susp. Del. de Barra de Torsión Exc. Control de Manejo Electrónico ZX3 y Quadrateer	E.O.	RS999265 <sup>XL</sup>	RS999198 <sup>XL</sup>	-	RS7198	RS55265 <sup>X</sup>	RS55198 <sup>X</sup>
1999-07	Pickup (1/2 Ton) 2WD Sierra 1500 c/ Susp. Del. de Barra de Resorte Exc. Control de Manejo Electrónico ZX3 y Paquete Quadrateer	E.O.	RS999263 <sup>XL</sup>	RS999262 <sup>XL</sup>	-	-	RS55263 <sup>X</sup>	RS55262 <sup>X</sup>
2001-03	Pickup (1/2 Ton) 2WD Sierra 1500HD - Exc. Control de Manejo Electrónico ZX3 y Quadrateer	E.O.	RS999295 <sup>XL</sup>	RS999274 <sup>XL</sup>	-	-	RS5295	RS55274 <sup>X</sup>
1988-98	Pickup (1/2 Ton) 2WD C-1500	E.O.	RS999166 <sup>XL</sup>	RS999190 <sup>XL</sup>	-	RS7190	-	RS55190 <sup>X</sup>
1987	Pickup (1/2 Ton) 2WD R-10	1 1/2"	RS999120 <sup>XL</sup>	RS999118 <sup>XL</sup>	-	RS7118	-	RS55118 <sup>X</sup>
1973-86	Pickup (1/2 Ton) 2WD C-10	1 1/2"	RS999120 <sup>XL</sup>	RS999118 <sup>XL</sup>	-	RS7118	-	RS55118 <sup>X</sup>
2011-22	Pickup 4WD (3/4 Ton) Sierra 2500HD	1 1/2"		-	-	-	RS55378 <sup>X</sup> <sub>313</sub>	-
2011-22	Pickup 4WD (3/4 Ton) Sierra 2500HD	E.O.	RS999377 <sup>XL</sup>	RS999379	-	-	RS5377 RS55377 <sup>X</sup>	RS55379 <sup>X</sup>
2011-18	Pickup 4WD (3/4 Ton) Sierra 2500HD	5 - 6"	-	-	-	-	RS55382 <sup>X</sup>	RS55383 <sup>X</sup>
2011-18	Pickup 4WD (3/4 Ton) Sierra 2500HD	4"	-	-	-	-	RS55380 <sup>X</sup>	RS55380 <sup>X</sup>
2001-10	Pickup 4WD (3/4 Ton) Sierra 2500HD c/ 9,200 lb. PBV	5 - 6"	RS999055 <sup>XL</sup>	RS999056 <sup>XL</sup>	-	-	-	-
2001-10	Pickup 4WD (3/4 Ton) Sierra 2500HD c/ 9,200 lb. PBV	E.O.	RS999288 <sup>XL</sup>	RS999274 <sup>XL</sup>	-	-	RS55288 <sup>X</sup>	RS55274 <sup>X</sup>
1999-04	Pickup 4WD (3/4 Ton) Sierra 2500 h/ 8,600 lb. PBV - Exc. Quadrateer	E.O.	RS999263 <sup>XL</sup>	RS999274 <sup>XL</sup>	-	-	RS55263 <sup>X</sup>	RS55274 <sup>X</sup>
1988-00	Pickup 4WD (3/4 Ton) K-2500	E.O.	RS999 <sup>152XL 148</sup>	RS999190 <sup>XL</sup>	RS7150	RS7190	RS55150 <sup>X</sup>	RS55190 <sup>X</sup>
2011-22	Pickup 2WD (3/4 Ton) Sierra 2500HD	1 1/2"		-	-	-	RS55378 <sup>X</sup> <sub>313</sub>	-
2011-22	Pickup 2WD (3/4 Ton) Sierra 2500HD	E.O.	RS999377 <sup>XL</sup>	RS999379 <sup>XL</sup>	-	-	RS5377 RS55377 <sup>X</sup>	RS55379 <sup>X</sup>
2011-18	Pickup 2WD (3/4 Ton) Sierra 2500HD	5 - 6"	-	-	-	-	RS55382 <sup>X</sup>	RS55383 <sup>X</sup>
2011-18	Pickup 2WD (3/4 Ton) Sierra 2500HD	4"	-	-	-	-	RS55380 <sup>X</sup>	RS55380 <sup>X</sup>
2001-10	Pickup 2WD (3/4 Ton) Sierra 2500HD c/ 9,200 lb. PBV	5 - 6"	RS999055 <sup>XL</sup>	RS999056 <sup>XL</sup>	-	-	-	-
2001-10	Pickup 2WD (3/4 Ton) Sierra 2500HD c/ 9,200 lb. PBV c/ RS6548 o RS6548B	4"	RS999289 <sup>XL</sup>	RS999297 <sup>XL</sup>	-	-	RS55289 <sup>X</sup>	-
2001-10	Pickup 2WD (3/4 Ton) Sierra 2500HD c/ 9,200 lb. PBV Exc. Autoride y c/ Susp. de Aire	E.O.	-	-	-	-	-	RS55297 <sup>X</sup>
2001-10	Pickup 2WD (3/4 Ton) Sierra 2500HD c/ 9,200 lb. PBV	E.O.	RS999288 <sup>XL</sup>	RS999274 <sup>XL</sup>	-	-	RS55288 <sup>X</sup>	RS55274 <sup>X</sup>
1999-04	Pickup 2WD (3/4 Ton) Sierra 2500 h/ 8,600 lb. PBV - Exc. Quadrateer	E.O.	RS999263 <sup>XL</sup>	RS999274 <sup>XL</sup>	-	-	RS55263 <sup>X</sup>	RS55274 <sup>X</sup>
1988-00	Pickup 2WD (3/4 Ton) C-2500	E.O.	RS999166 <sup>XL 24</sup>	RS999190 <sup>XL</sup>	-	RS7190	-	RS55190 <sup>X</sup>
2011-22	Pickup 4WD (1 Ton) Sierra 3500HD	1 1/2"		-	-	-	RS55378 <sup>X</sup> <sub>313</sub>	-
2011-18	Pickup 4WD (1 Ton) Sierra 3500HD	5 - 6"	-	-	-	-	RS55382 <sup>X</sup>	RS55383 <sup>X</sup>
2001-10	Pickup 4WD (1 Ton) Sierra 3500 c/ 11,400 lb. PBV Inc. Chassis Cab	E.O.	RS999288 <sup>XL</sup>	RS999262 <sup>XL</sup>	-	-	RS55288 <sup>X</sup>	RS55262 <sup>X</sup>

AÑO	APLICACIÓN	ALTURA	RS9000XL		RS7000MT		RS5000/RS500X	
			DELANTERO	TRASERO	DELANTERO	TRASERO	DELANTERO	TRASERO
<b>GM (CONT.)</b>								
1988-00	Pickup 4WD (1 Ton) K-3500	E.O.	RS999150 <sup>XL</sup>	RS999190 <sup>XL</sup>	RS7150	RS7190	RS55150 <sup>X</sup>	RS55190 <sup>X</sup>
2011-22	Pickup 4WD (1 Ton) Sierra 3500HD	1 1/2"		-	-	-	RS55378 <sup>X</sup> <sub>313</sub>	-
2011-18	Pickup 2WD (1 Ton) Sierra 3500HD	5 - 6"	-	-	-	-	RS55382 <sup>X</sup>	RS55383 <sup>X</sup>
2001-10	Pickup (1 Ton) 2WD Sierra 3500 c/ Susp. Del. Indep. - Inc. Chasis Cab	E.O.	-	-	-	-	RS55288 <sup>X</sup>	RS55262 <sup>X</sup>
1992-00	Pickup (1Ton) 2WD C-3500 Crew Cab	E.O.	RS999166 <sup>XL</sup> 24	RS999190 <sup>XL</sup>	-	RS7190	-	RS55190 <sup>X</sup>
1987-00	Pickup (1 Ton) 2WD C-3500 - Exc. Crew Cab y Modelos 3500HD	E.O.	RS999166 <sup>XL</sup> 24	RS999190 <sup>XL</sup>	-	RS7190	-	RS55190 <sup>X</sup>
1973-86	Pickup (1Ton) 2WD C-30,R-30,R-3500 - Inc. Crew Cab	E.O.	RS999120 <sup>XL</sup>	RS999118 <sup>XL</sup>	-	RS7118	-	RS55118 <sup>X</sup>
2015-22	Pickup 4WD Canyon	E.O.	-	-	-	-	RS55840 <sup>X</sup>	RS550 <sup>23X</sup>
2004-12	Pickup 4WD Canyon - c/ Rancho RS6569B c/ Eje de transmisión de aluminio trasero	4"	-	-	-	-	RS55610 <sup>X</sup>	RS55301 <sup>X</sup>
2004-12	Pickup 4WD Canyon - c/ Rancho RS6569B Exc. c/ Eje de transmisión de aluminio trasero	4"	-	-	-	-	RS55610 <sup>X</sup>	RS55325 <sup>X</sup>
2004-12	Pickup 4WD Canyon	E.O.	RS999300 <sup>XL</sup>	RS999301 <sup>XL</sup>	-	-	-	RS55301 <sup>X</sup>
2015-22	Pickup 2WD Canyon	E.O.	-	-	-	-	RS55840 <sup>X</sup>	RS550 <sup>23X</sup>
2004-12	Pickup 2WD Canyon - c/ Rancho RS6569B c/ Eje de transmisión de aluminio trasero	4"	-	-	-	-	RS55610 <sup>X</sup>	RS55301 <sup>X</sup>
2004-12	Pickup 2WD Canyon - c/ Rancho RS6569B Exc. c/ Eje de transmisión de aluminio trasero	4"	-	-	-	-	RS55610 <sup>X</sup>	RS55325 <sup>X</sup>
2004-12	Pickup 2WD Canyon c/ Susp. Del. de Resorte - Exc. Z71	E.O.	-	RS999299 <sup>XL</sup>	-	-	RS5770	-
2004-12	Pickup 2WD Canyon c/ Susp. Del. de Barra de Torsión y Z71	E.O.	RS999300 <sup>XL</sup>	RS999301 <sup>XL</sup>	-	-	-	RS55301 <sup>X</sup>
2007-14	Yukon XL 1500 2WD y 4WD - Exc. c/ Susp. Z55 y Z95	2"	-	-	-	-	RS55785 <sup>X</sup>	RS55262 <sup>X</sup>
2007-14	Yukon XL 1500 2WD y 4WD - Exc. c/ Susp. Z55 y Z95	E.O.	RS999784 <sup>XL</sup>	RS999262 <sup>XL</sup>	-	-	RS55784 <sup>X</sup>	RS55262 <sup>X</sup>
2000-06	Yukon XL 1500 2WD y 4WD - Exc. c/ Susp. Z55 y c/ Susp. Nivomat ZW7	E.O.	RS999265 <sup>XL</sup>	RS999262 <sup>XL</sup>	-	-	RS55265 <sup>X</sup>	RS55262 <sup>X</sup>
2000-06	Yukon XL 1500 2WD y 4WD - c/ Susp. ZW7 Exc. c/ Z55	E.O.	RS999265 <sup>XL</sup>	-	-	-	RS55265 <sup>X</sup>	-
2000-08	Yukon XL 2500 2WD y 4WD - Exc. c/ Susp. Z55 y Paquete Quadrasteer	E.O.	-	-	-	-	-	RS55262 <sup>X</sup>
2007-14	Yukon 2WD y 4WD - Exc. c/ Susp. Z55 y c/ Susp. Nivomat ZW7	E.O.	RS999784 <sup>XL</sup>	RS999262 <sup>XL</sup>	-	-	-	RS55262 <sup>X</sup>
2000-06	Yukon 2WD y 4WD - Exc. c/ Susp. Z55 y c/ Susp. Nivomat	E.O.	RS999265 <sup>XL</sup>	RS999262 <sup>XL</sup>	-	-	RS55265 <sup>X</sup>	RS55262 <sup>X</sup>
1995-99	Yukon 4WD - Todos 4 puertas Inc. Denali	0 - 1"	RS999150 <sup>XL</sup>	RS999124 <sup>XL</sup>	RS7150	-	RS55150 <sup>X</sup>	RS55124 <sup>X</sup>
1995-99	Yukon 5WD - Todos 4 puertas c/ Rancho RS6267	4"	-	-	-	-	RS55128 <sup>X</sup>	-

GM Amortiguador de dirección Rancho		RS7000MT/RS5000			
		Tipo	Kit	Sin Soporte	Soporte
2005-08	Pickup Sierra 4x2 1500HD Clasico	Sencillo	-	-	RS5548
2005-07	Pickup Sierra 4x4 1500HD	Sencillo	-	-	RS5548
2001-03	Pickup Sierra 4x2 y 4x4 1500HD - Doble Cabina	Sencillo	-	-	RS5548
2001-08	Pickup Sierra 2500HD 4x2 y 4x4 c/ 9,200 lbs. de PBV (Sin soporte de E.O. para amortiguador de dirección)	Sencillo	-	-	RS5548
1999-04	Pickup Sierra 2500 4x4 h/ 8,600 lbs. de PBV	Sencillo	-	-	RS5548
2000-06	Yukon XL 4x4 h/ PBV de 8,600 lbs.	Sencillo	-	-	RS5548

HONDA		ALTURA	RS9000XL	RS7000MT	RS5000/RS500X
2002-06	CR-V	E.O.			RS5825



AÑO	APLICACIÓN	ALTURA	RS9000XL		RS7000MT		RS5000/RS500X	
			DELANTERO	TRASERO	DELANTERO	TRASERO	DELANTERO	TRASERO
<b>HUMMER</b>								
2003-09	H2	1 - 1 1/2"	-	-	-	-	RS55370 <sup>X</sup> <sub>313</sub>	-
2003-09	H2	E.O.	RS999288 <sup>XL</sup>	RS999269 <sup>XL</sup>	-	-	RS55288 <sup>X</sup>	RS55269 <sup>X</sup>
2003-09	H2 c/ Sistema RS6556 o RS6557 - Exc. Trans. Manual	E.O.	-	-	-	-	RS55289 <sup>X</sup>	RS55297 <sup>X</sup>
2000-09	H2 AWD - Inc. Modelos SUT	5 - 6"	RS999055 <sup>XL</sup>	RS999056 <sup>XL</sup>	-	-	-	-
2006-10	H3	1 - 2 1/2"	-	-	-	-	RS55376 <sup>X</sup>	-
2006-10	H3	E.O.	RS999307 <sup>XL</sup>	RS999308 <sup>XL</sup>	-	-	-	RS55308 <sup>X</sup>

<b>JEEP</b>								
1991-01	Cherokee XJ	E.O.	RS999128 <sup>XL</sup>	RS999129 <sup>XL</sup>	-	-	RS55128 <sup>X</sup>	RS55129 <sup>X</sup>
1984-01	Cherokee XJ 4WD	E.O.	-	-	-	-	RS55128 <sup>X</sup>	RS55129 <sup>X</sup>
1984-01	Cherokee XJ 4WD c/ 3 o c/ 4 ballestas traseras	1 1/2"	-	-	-	-	-	RS55129 <sup>X</sup>
1984-01	Cherokee XJ	3"	-	RS999245 <sup>XL</sup>	-	-	-	RS55245 <sup>X</sup>
1984-97	Cherokee XJ c/ Sistema Rancho	3"	RS999239 <sup>XL</sup>	RS999129 <sup>XL</sup>	-	-	RS55239 <sup>X</sup>	RS55129 <sup>X</sup>
2006-10	Commander	E.O.	-	-	-	-	-	RS55398 <sup>X</sup>
2020-22	Gladiator JT 4WD - Exc. Mojave	2-3"	RS999065 <sup>XL</sup>	-	-	-	RS55065 <sup>X</sup>	-
2020-22	Gladiator JT 4WD - Exc. Mojave	E.O.	-	-	-	-	RS55063 <sup>X</sup>	-
2005-10	Grand Cherokee	E.O.	-	-	-	-	-	RS55398 <sup>X</sup>
1999-04	Grand Cherokee WJ	E.O.	RS999128 <sup>XL</sup>	RS999260 <sup>XL</sup>	-	-	RS55128 <sup>X</sup>	RS55260 <sup>X</sup>
1999-01	Grand Cherokee WJ	2"	RS999239 <sup>XL</sup>	RS999260 <sup>XL</sup>	-	-	RS55239 <sup>X</sup>	RS55260 <sup>X</sup>
1993-98	Grand Cherokee ZJ	3"	RS999239 <sup>XL</sup>	RS999194 <sup>XL</sup>	-	-	RS55239 <sup>X</sup>	-
1993-98	Grand Cherokee ZJ	2"	RS999239 <sup>XL</sup>	RS999194 <sup>XL</sup>	-	-	RS55239 <sup>X</sup>	-
1993-98	Grand Cherokee ZJ	E.O.	RS999128 <sup>XL</sup>	RS999259 <sup>XL</sup>	-	-	RS55128 <sup>X</sup>	-
2002-11	Liberty	E.O.	RS999764 <sup>XL</sup>	RS999284 <sup>XL</sup>	-	-	RS5764	RS55284 <sup>X</sup>
2007-18	Wrangler JK 4WD c/ RS6509, RS6509B, RS6517 o RS6517B	4"	RS999331 <sup>XL</sup>	RS999332 <sup>XL</sup>	RS7331	-	RS55331 <sup>X</sup>	RS55332 <sup>X</sup>
2007-16	Wrangler JK 4WD c/ RS6507 o RS6507B	4"	RS999329 <sup>XL</sup>	RS999330 <sup>XL</sup>	RS7331	-	RS5329	RS55330 <sup>X</sup>
			-	-	-	-	RS55329 <sup>X</sup>	-
2007-16	Wrangler JK 4WD	0 - 2"	RS999326 <sup>XL</sup>	RS999328 <sup>XL</sup>	-	-	RS55326 <sup>X</sup>	RS55328 <sup>X</sup>
2007-10	Wrangler JK 2WD	0 - 2"	RS999326 <sup>XL</sup>	RS999327 <sup>XL</sup>	-	-	RS55326 <sup>X</sup>	-
2018-22	Wrangler JL Todos - Exc. Rubicon 4WD	3 1/2"	RS999065 <sup>XL</sup>	RS999066 <sup>XL</sup>	-	-	RS55065 <sup>X</sup>	RS55066 <sup>X</sup>
2018-22	Wrangler JL Rubicon 4WD	2"	RS999065 <sup>XL</sup>	RS999066 <sup>XL</sup>	-	-	RS55065 <sup>X</sup>	RS55066 <sup>X</sup>
2018-22	Wrangler JL 4WD - Exc. Unlimited Rubicon 392	E.O.	-	-	-	-	RS55063 <sup>X</sup>	RS55064 <sup>X</sup>
1997-06	Wrangler TJ	5 - 6"	RS999061 <sup>XL</sup>	RS999062 <sup>XL</sup>	-	-	-	-
1997-06	Wrangler TJ - c/ RS6501 o RS6504	3.5 - 4"	-	-	-	-	RS55255 <sup>X</sup>	-
1997-06	Wrangler TJ - c/ RS6501 o RS6504	0"	-	-	-	-	-	RS55256 <sup>X</sup>
1997-06	Wrangler TJ - c/ RS6505 o RS6506	2 1/2"	RS999255 <sup>XL</sup>	RS999256 <sup>XL</sup>	-	-	-	-
1997-06	Wrangler TJ - c/ RS6502 o RS6503	2 1/2"	RS999239 <sup>XL</sup>	RS999241 <sup>XL</sup>	-	RS7241	RS55239 <sup>X</sup>	RS55241 <sup>X</sup>
1997-06	Wrangler TJ - c/ 4 cil. y techo blando, 4 y 6 cil. y techo rígido - Exc. Rubicon y Unlimited	2 1/2"	-	-	-	-	RS55239 <sup>X</sup>	RS55241 <sup>X</sup>
1997-06	Wrangler TJ	0"	RS999128 <sup>XL</sup>	RS999240 <sup>XL</sup>	-	RS71240	RS55128 <sup>X</sup>	RS55240 <sup>X</sup>
1986-96	Wrangler 4WD YJ c/ Sistema Rancho	2 1/2"	RS999168 <sup>XL</sup>	RS999118 <sup>XL</sup> <sub>316</sub>	RS7168	RS7118	RS55168 <sup>X</sup>	RS55118 <sup>X</sup>
1986-96	Wrangler 4WD YJ	0 - 1 1/2"	RS999168 <sup>XL</sup>	RS999113 <sup>XL</sup> <sub>316</sub>	RS7168	RS7113	RS55168 <sup>X</sup>	RS55113 <sup>X</sup>

		<b>RS7000MT/RS5000</b>			
<b>JEEP Amortiguador de dirección Rancho</b>		<b>Tipo</b>	<b>Kit</b>	<b>Sin Soporte</b>	<b>Soporte</b>
1999-04	Grand Cherokee c/ Amortiguador de Dirección de Equipo Original (Utiliza Monturas de E.O.)	Sencillo	-	RS5409	-
2007-12	Wrangler JK 4x4	Sencillo	RS97356	RS5407	-
1997-06	Wrangler TJ c/ Amortiguador de Dirección de Equipo Original (Utiliza Monturas de E.O.)	Sencillo	-	RS5407	-
1986-96	Wrangler YJ 4x4 c/ Amortiguador de Dirección de Equipo Original (Utiliza Monturas de E.O.)	Sencillo	-	RS5407	-

AÑO	APLICACIÓN	ALTURA	RS9000XL		RS7000MT		RS5000/RS500X	
			DELANTERO	TRASERO	DELANTERO	TRASERO	DELANTERO	TRASERO
<b>LINCOLN</b>								
2006-08	Mark LT 4WD (1/2 Ton) Pickup	E.O.	-	RS999286 <sup>XL</sup>	-	-	RS55767 <sup>X</sup>	-

<b>NISSAN</b>								
2004-15	Armada - Exc. c/ Sistema Autonivelable Trasero	E.O.	-	RS999306 <sup>XL</sup>	-	-	RS55827 <sup>X</sup>	-
2004-13	Armada c/ RS6595B - Exc. c/ Sistema Autonivelable Trasero	4"	RS999773 <sup>XL</sup>	RS999306 <sup>XL</sup>	-	-	-	-
2005-16	Frontier 4WD	E.O.	RS999787 <sup>XL</sup>	RS999311 <sup>XL</sup>	-	-	-	-
2000-04	Frontier 4WD Crew Cab	E.O.	RS999188 <sup>XL</sup>	RS999341 <sup>XL</sup>	-	RS7113	RS55188 <sup>X</sup>	RS55113 <sup>X</sup>
1998-04	Frontier 4WD - Exc. Crew Cab	E.O.	RS999188 <sup>XL</sup>	RS999341 <sup>XL</sup>	-	RS7113	RS55188 <sup>X</sup>	RS55113 <sup>X</sup>
								RS55113 <sup>X</sup>
2005-16	Frontier 2WD	E.O.	RS999787 <sup>XL</sup>	RS999311 <sup>XL</sup>	-	-	-	-
2005-13	Frontier 2WD Desert Runner	E.O.	RS999188 <sup>XL</sup>	RS999333 <sup>XL</sup>	-	-	-	-
1998-04	Frontier 2WD Crew Cab - Exc. Desert Runner	E.O.	RS999188 <sup>XL</sup>	RS999333 <sup>XL</sup>	-	-	RS55188 <sup>X</sup>	RS55116 <sup>X</sup>
1998-04	Frontier 2WD - Exc. Crew Cab y Desert Runner	E.O.	-	RS999341 <sup>XL</sup>	-	RS7113	-	RS55113 <sup>X</sup>
2005-12	Pathfinder 4WD	E.O.	RS999787 <sup>XL</sup>	RS999312 <sup>XL</sup>	-	-	-	-
2005-12	Pathfinder 2WD	E.O.	RS999787 <sup>XL</sup>	RS999312 <sup>XL</sup>	-	-	-	-
Jul 1986-97	Pickup 4WD y 2WD	0 - 1 1/2"	-	RS999113 <sup>XL</sup>	-	RS7113	-	RS55113 <sup>X</sup>
2004-15	Titan 4WD - Exc. PRO-4X	E.O.	-	RS999303 <sup>XL</sup>	-	-	RS55827 <sup>X</sup>	RS55395 <sup>X</sup>
2004-15	Titan 2WD	E.O.	-	RS999303 <sup>XL</sup>	-	-	RS55827 <sup>X</sup>	RS55394 <sup>X</sup>
2005-15	Xterra 4WD	E.O.	RS999787 <sup>XL</sup>	RS999314 <sup>XL</sup>	-	-	-	-
2005-15	Xterra 2WD	E.O.	RS999787 <sup>XL</sup>	RS999313 <sup>XL</sup>	-	-	-	-

<b>TOYOTA</b>								
2003-20	4 Runner - Exc. Delphi REAS, Kinetic Dynamic	E.O.	-	RS999305 <sup>XL</sup>	-	-	RS55777 <sup>X</sup>	-
1996-02	4 Runner Todos - c/ Motor de 4 Cilindros	E.O.	RS999762 <sup>XL 152</sup>	RS999187 <sup>XL</sup>	-	-	RS55762 <sup>X 152</sup>	RS55187 <sup>X</sup>
1996-02	4 Runner Todos - c/ Motor de 6 Cilindros	E.O.	RS999763 <sup>XL 152</sup>	RS999187 <sup>XL</sup>	-	-	RS55763 <sup>X 152</sup>	RS55187 <sup>X</sup>
1990-95	4 Runner - Todos	0 - 1"	RS999145 <sup>XL</sup>	RS999187 <sup>XL</sup>	-	-	RS55145 <sup>X</sup>	RS55187 <sup>X</sup>
1986-89	4 Runner - Todos	0 - 1"	RS999145 <sup>XL</sup>	RS999180 <sup>XL</sup>	-	-	RS55145 <sup>X</sup>	RS55180 <sup>X</sup>
1984-85	4 Runner - Todos	0 - 2"	-	-	-	-	-	RS55144 <sup>X</sup>
1989-95	Pickup 4WD - Todos	0 - 1"	RS999145 <sup>XL</sup>	RS999180 <sup>XL</sup>	-	-	RS55145 <sup>X</sup>	RS55180 <sup>X</sup>
1993-98	Pickup 4WD T100 - Todos	0 - 1"	RS999145 <sup>XL</sup>	RS999116 <sup>XL</sup>	-	-	RS55145 <sup>X</sup>	RS55116 <sup>X</sup>
2005-20	Tacoma 4WD	E.O.	RS999777 <sup>XL</sup>	RS999319 <sup>XL</sup>	-	-	RS55777 <sup>X</sup>	RS55319 <sup>X</sup>
1995-04	Tacoma 4WD	E.O.						
	Izquierda		RS999762 <sup>XL 152</sup>	RS999226 <sup>XL</sup>	-	-	RS55762 <sup>X 152</sup>	RS55226 <sup>X</sup>
	Derecha		RS999762 <sup>XL 152</sup>	RS999180 <sup>XL</sup>	-	-	RS55762 <sup>X 152</sup>	RS55180 <sup>X</sup>
1995-98	Tacoma 4WD	1 - 1 1/2"						
	Izquierda		-	-	-	-	-	RS55180 <sup>X</sup>
	Derecha		-	-	-	-	-	RS55144 <sup>X</sup>
2016-20	Tacoma 2WD - Todos	E.O.	RS999777 <sup>XL</sup>	RS999319 <sup>XL</sup>	-	-	RS55777 <sup>X</sup>	RS55319 <sup>X</sup>
2005-15	Tacoma 2WD c/ Paquete Pre Runner o TRD	E.O.	RS999777 <sup>XL</sup>	RS999319 <sup>XL</sup>	-	-	RS55777 <sup>X</sup>	RS55319 <sup>X</sup>
2005-15	Tacoma 2WD	E.O.	-	RS999320 <sup>XL</sup>	-	-	-	-
1998-04	Tacoma 2WD c/ Paq. Off Road o Paquete Pre Runner	E.O.						
	Izquierda		RS999762 <sup>XL 152</sup>	RS999226 <sup>XL</sup>	-	-	RS55762 <sup>X 152</sup>	RS55226 <sup>X</sup>
	Derecha		RS999762 <sup>XL 152</sup>	RS999180 <sup>XL</sup>	-	-	RS55762 <sup>X 152</sup>	RS55180 <sup>X</sup>





AÑO	APLICACIÓN	ALTURA	RS9000XL		RS7000MT		RS5000/RS500X	
			DELANTERO	TRASERO	DELANTERO	TRASERO	DELANTERO	TRASERO
<b>TOYOTA (CONT.)</b>								
1995-04	Tacoma 2WD - Exc. c/ Paq. Off-Road o Pre Runner	E.O.	-	RS999006 <sup>XL</sup>	-	-	RS55609 <sup>X</sup>	-
2007-16	Tundra Pickup 4WD	E.O.	RS999758 <sup>XL</sup>	RS999324 <sup>XL</sup>	-	-	-	-
2000-06	Tundra Pickup 4WD	E.O.	RS999766 <sup>XL</sup>	RS999040 <sup>XL</sup>	-	-	RS55766 <sup>X</sup>	-
2007-16	Tundra Pickup 2WD	E.O.	RS999758 <sup>XL</sup>	RS999324 <sup>XL</sup>	-	-	-	-
2000-06	Tundra Pickup 2WD	E.O.	RS999766 <sup>XL</sup>	-	-	-	RS55766 <sup>X</sup>	RS55041 <sup>X</sup>

\* Nueva línea RS5000X

## QUICK LIFT LOADED

MODELO	AÑO	ALTURA		QUICK LIFT LOADED		TRASERO RS9000 <sup>XL</sup>	TAMAÑO DE LLANTA
		DELANTERA	TRASERA	DELANTERO	TRASERO		
<b>CHEVROLET/GM</b>							
Silverado LTD 2/4W.D. - Exc. Custom Trail Boss y LT Trail Boss c/ Susp. Z7X, ZR2, Cabina Estandar, Motor de 4 Cilindros, Modelo High Country c/ Susp. Adaptive Control	2022	2.00"	0"	RS999950 <sup>QL</sup>			
Silverado LTD 2/4W.D. - Custom Trail Boss y LT Trail Boss; Exc. ZR2, Motor de 4 Cilindros	2022	0"	0"	RS999950 <sup>QL</sup>			
Silverado 2/4W.D. - Exc. Custom Trail Boss y LT Trail Boss c/ Z7X, ZR2, Modelos c/ Cabina Estandar, Motor de 4 Cilindros, Modelos High Country c/ Susp. Adaptive Control	2020-2022	2.00"	0"	RS999950 <sup>QL</sup>		RS999198 <sup>XL</sup>	
Silverado 2/4W.D. - Custom Trail Boss y LT Trail Boss - Exc. ZR2 y c/ Motor de 4 Cilindros	2019-2022	0"	0"	RS999950 <sup>QL</sup>		RS999269 <sup>XL</sup>	
Silverado 2/4W.D. - Nuevo modelo - Exc. Submodelos Custom Trail Boss y LT Trail Boss c/ Susp. Z7X; Cabina Estandar, Motor de 4 Cilindros	2019	2.00"	0"	RS999950 <sup>QL</sup>		RS999198 <sup>XL</sup>	
Sierra 1500 Limited 2W.D. - Exc. Cabina Estandar; Motor 4 Cilindros, Denali	2022	2.00"	0"	RS999950 <sup>QL</sup>		RS999198 <sup>XL</sup>	
Sierra 1500 2/4W.D. - Exc. Cabina Estandar; Motor 4 Cilindros, Denali	2020-2022	2.00"	0"	RS999950 <sup>QL</sup>		RS999198 <sup>XL</sup>	
Sierra 1500 2/4W.D. - ; Nuevo modelo: Exc. Cabina Estandar; Motor de 4 Cilindros	2019	2.00"	0"	RS999950 <sup>QL</sup>		RS999198 <sup>XL</sup>	
Silverado/Sierra 2/4W.D. - Exc c/ Paquete Z71	2007 - 2019	2.00"		RS999901 <sup>QL</sup>		RS999198 <sup>XL</sup>	285/70/R17
Tahoe/Yukon/Avalanche/Suburban 2/4WD - Exc. Autoride y Z71	2007 - 2019	2.00"	0.75"	RS999901 <sup>QL</sup>	RS70075+	RS999262 <sup>XL</sup>	285/70/R17
Tahoe/Yukon/Avalanche/Suburban 2/4WD - Inc. Autoride y Z71	2007 - 2014	2.00"		RS999928 <sup>QL*</sup>		Equipo Original	285/70/R17
<b>DODGE</b>							
Ram 1500 Classic 4W.D - (Modelo anterior); Combustible Gas o Flex, Exc. Air Suspension	2019 - 2022	2"					
Izquierdo				RS999944 <sup>QL</sup>			
Derecho				RS999930 <sup>QL</sup>			
Ram 1500 4W.D. - Exc. Mega Cab y TRX	2009 - 2018	1.75"					
Izquierdo				RS999944 <sup>QL</sup>			RS999367 <sup>XL</sup>
Derecho				RS999930 <sup>QL</sup>		RS999367 <sup>XL</sup>	275/65/R20
Ram 1500 4W.D. - Exc. Mega Cab y TRX	2006 - 2008	1.25"					
Izquierdo				RS999943 <sup>QL</sup>			RS999274 <sup>XL</sup>
Derecho				RS999929 <sup>QL</sup>		RS999274 <sup>XL</sup>	275/65/R20
Ram TRX 1500 4W.D. - Exc. Mega Cab	2006 - 2008	1.00"					
Izquierdo				RS999943 <sup>QL</sup>			RS999274 <sup>XL</sup>
Derecho				RS999929 <sup>QL</sup>		RS999274 <sup>XL</sup>	275/65/R20
<b>FORD</b>							
F-150 1/2 Ton - 4W.D.	2015-2020	2.50"					
Izquierdo				RS999946 <sup>QL</sup>			
Derecho				RS999945 <sup>QL</sup>			
F-150 4W.D.	2009 - 2013	2.00"					
Izquierdo				RS999935 <sup>QL</sup>			RS999286 <sup>XL</sup>
Derecho				RS999911 <sup>QL</sup>		RS999286 <sup>XL</sup>	35x12.5 R18
F-150 2W.D. - Exc. Std. Cab, Diesel	2014-19	2.25"					
Izquierdo				RS999948 <sup>QL</sup>			
Derecho				RS999947 <sup>QL</sup>			

## QUICK LIFT LOADED

MODELO	AÑO	ALTURA		QUICK LIFT LOADED		TRASERO RS9000 <sup>XL</sup>	TAMAÑO DE LLANTA
		DELANTERA	TRASERA	DELANTERO	TRASERO		
<b>FORD (CONT.)</b>							
F-150 2W.D. Izquierdo	2009 - 2013	1.50"		RS999936 <sup>QL</sup>		RS999286 <sup>XL</sup>	35x12.5 R20
Derecho				RS999912 <sup>QL</sup>		RS999286 <sup>XL</sup>	35x12.5 R20
F-150 4W.D. Inc. 8,200 lb. PBV	2004 - 2008	2.00"		RS999910 <sup>QL</sup>		RS999286 <sup>XL</sup>	35x12.5 R18
F-150 2W.D.	2004 - 2008	1.50"		RS999909 <sup>QL</sup>		RS999285 <sup>XL</sup>	35x12.5 R20
Expedition 4W.D. - Exc. c/ Suspensión de Aire Izquierdo	2007 - 2012	1.25"	1.25"	RS999940 <sup>QL</sup>	RS999941 <sup>QL</sup>		275/65/R20
Derecho				RS999925 <sup>QL</sup>	RS999926 <sup>QL</sup>		275/65/R20
Expedition 4W.D. - Exc. c/ Suspensión de Aire Izquierdo	2003 - 2006	1.25"	1.25"	RS999932 <sup>QL</sup>	RS999933 <sup>QL</sup>		275/65/R20
Derecho				RS999902 <sup>QL</sup>	RS999903 <sup>QL</sup>		275/65/R20
Explorer 2/4W.D. Izquierdo	2006 - 2011	1.50"	1.25"	RS999939 <sup>QL</sup>	-		265/70/R17
Derecho				RS999924 <sup>QL</sup>	-		265/70/R17
Explorer 2/4W.D. Izquierdo	2004 - 2005	1.50"	1.25"	RS999904 <sup>QL</sup>	RS999934 <sup>QL</sup>		265/70/R17
Derecho				RS999904 <sup>QL</sup>	RS999905 <sup>QL</sup>		265/70/R17
Explorer 2/4W.D. Izquierdo	2000 - 2002	1.50"	1.25"	RS999904 <sup>QL</sup>	RS999934 <sup>QL</sup>		265/75/R16
Derecho				RS999904 <sup>QL</sup>	RS999905 <sup>QL</sup>		265/75/R16
<b>LINCOLN</b>							
Mark LT 4WD	2006-2008	1.50"		RS999910 <sup>QL</sup>		RS999286 <sup>XL</sup>	35x12.5 R18
<b>MERCURY</b>							
Mountaineer 2/4W.D. Izquierdo	2006 - 2011	1.50"	1.25"	RS999939 <sup>QL</sup>			265/70/R17
Derecho				RS999924 <sup>QL</sup>			265/70/R17
Mountaineer 2/4W.D. Izquierdo	2004 - 2005	1.50"	1.25"	RS999904 <sup>QL</sup>	RS999934 <sup>QL</sup>		265/70/R17
Derecho				RS999904 <sup>QL</sup>	RS999905 <sup>QL</sup>		265/70/R17
Mountaineer 2/4W.D. Izquierdo	2002 - 2003	1.50"	1.25"	RS999904 <sup>QL</sup>	RS999934 <sup>QL</sup>		265/75/R16
Derecho				RS999904 <sup>QL</sup>	RS999905 <sup>QL</sup>		265/75/R16
<b>NISSAN</b>							
Armada 2/4W.D. - Exc. Nivelación Trasera Automática Izquierdo	2004 - 2015	2.25"	1.75"	RS999937 <sup>QL</sup>	RS70076+		305/65R18
Derecho				RS999921 <sup>QL</sup>	RS70076+		305/65R18
Frontier 2/4W.D. - Exc. Nismo & Pro-4x	2005 - 2021	2.00"		RS999922 <sup>QL</sup>		RS999311 <sup>XL</sup>	285/75R16
Pathfinder 2/4W.D.	2005 - 2012	2.00"		RS999922 <sup>QL</sup>			285/75R16
Titan 2/4W.D. Izquierdo	2017-2019	2.25"	1.75"	RS999937 <sup>QL</sup>			305/65R18
Derecho				RS999921 <sup>QL</sup>			305/65R18

## QUICK LIFT LOADED

MODELO	AÑO	ALTURA		QUICK LIFT LOADED		TRASERO RS9000 <sup>XL</sup>	TAMAÑO DE LLANTA
		DELANTERA	TRASERA	DELANTERO	TRASERO		
<b>NISSAN (CONT.)</b>							
Titan 2/4W.D.	2004 - 2015	2.25"	1.75"				
Izquierdo				RS999937QL	-	RS999303	305/65R18
Derecho				RS999921QL	-	RS999303	305/65R18
Xterra 4W.D.	2005 - 2015	1.75"	1.50"	RS999922QL	RS70078+	RS999314	265/75/R16
Xterra 2W.D.	2005 - 2015	1.75"	1.50"	RS999922QL	RS70078+	RS999313	265/75/R16
<b>TOYOTA</b>							
4Runner 2/4W.D.	2003 - 2022	1.75"	1.50"				
Izquierdo				RS999913 <sup>QL</sup>	RS70080+	RS999305 <sup>XL</sup>	285/70/R17
Derecho				RS999914 <sup>QL</sup>	RS70080+	RS999305 <sup>XL</sup>	285/70/R17
FJ Cruiser	2006 - 2013	2.00"	1.50"				
Izquierdo				RS999913 <sup>QL</sup>	RS70080+	RS999305 <sup>XL</sup>	285/70/R17
Derecho				RS999914 <sup>QL</sup>	RS70080+	RS999305 <sup>XL</sup>	285/70/R17
Tacoma 4W.D.	2005 - 2018	2.75"		RS999915 <sup>QL</sup>		RS999319 <sup>XL</sup>	285/75/R16
Tacoma 4W.D.	1995 - 2004	1.75"					
Izquierdo				RS999907 <sup>QL</sup>		RS999226 <sup>XL</sup>	33x10.5 R15
Derecho				RS999908 <sup>QL</sup>		RS999180 <sup>XL</sup>	33x10.5 R15
Tacoma 2W.D. - Pre Runner or Off Road	1999 - 2004	1.75"					
Izquierdo				RS999907 <sup>QL</sup>		RS999226 <sup>XL</sup>	285/70/R17
Derecho				RS999908 <sup>QL</sup>		RS999180 <sup>XL</sup>	285/70/R17
Tundra 2/4W.D.	2007 - 2020	2.25"					
Izquierdo				RS999919 <sup>QL</sup>		RS999324 <sup>XL</sup>	275/65/R20
Derecho				RS999920 <sup>QL</sup>		RS999324 <sup>XL</sup>	275/65/R20
Tundra 4W.D.	2000 - 2006	2.25"					
Izquierdo				RS999923 <sup>QL</sup>		RS999040 <sup>XL</sup>	285/60/R18
Derecho				RS999931 <sup>QL</sup>		RS999040 <sup>XL</sup>	285/60/R18

.+ Kit de nivelación trasero, necesario para nivelar la altura trasera

\* Deshabilita la Suspensión Electrónica delantera



# PROGRESIVO AMORTIGUADORES

## INDICE PROGRESIVO DE APLICACIONES

Vehículo	Años Pos.	Vehículo	Años Pos.	Vehículo	Años Pos.
<b>1000</b>	(Pág. 106, 111)	<b>1412 (Cont.)</b>	(Pág. 39, 47, 53, 71, 82, 93, 109, 112)	<b>3147</b>	(Pág. 34-35, 38)
Monroe® Monro-Matic Hidraulico Amortiguador		Monroe® Monro-Matic Hidraulico Amortiguador		Monroe® Monro-Matic Hidraulico Amortiguador	
Nissan — Datsun	79-84 T	Jeep — Pickup S	66-84 D	Chevrolet — Chevy, Chevy Joy, Pop y Swing	93-12 T
Nissan — Tsubame	93-04 TD	Nissan — Pickup D-21	66-84 T	Chevrolet — Corsa	01-08 TD
	93-04 TI	Nissan — Van Urvan	65-94 T		01-08 TI
<b>1089</b>	(Pág. 137, 134)		98-03 T	Chevrolet — Monza	93-12 T
Monroe® Monro-Matic Hidraulico Amortiguador		<b>1414</b>	(Pág. 39, 44, 47, 53, 81-82)	<b>3155</b>	(Pág. 34)
Volkswagen — Brasilia	73-82 T	Monroe® Monro-Matic Hidraulico Amortiguador		Monroe® Monro-Matic Hidraulico Amortiguador	
Volkswagen — Safari	73-80 T	Chevrolet — Pickup C y R	63-87 D	Chevrolet — Chevy Pickup	93-05 T
Volkswagen — Sedán	53-04 T	Chevrolet — Suburban	73-91 D		(Pág. 129)
	53-72 D	Chevrolet — Van 1500 Express, Savana, Modelos G y P	73-89 D	Monroe® OESpectrum® Autos de Pasajeros Amortiguador	
<b>1195</b>	(Pág. 114)	Dina — 1000, 3000	63-66 D	Toyota — Prius V	12-16 TD
Monroe® Monro-Matic Hidraulico Amortiguador		GMC — Pickup Series C, R, K y V	78-90 D		12-16 TI
Peugeot — 206	99-09 T	<b>1415</b>	(Pág. 39, 44-45, 47, 53, 81)	<b>5504</b>	(Pág. 85)
<b>1401</b>	(Pág. 43, 83)	Monroe® Monro-Matic Hidraulico Amortiguador		Monroe® OESpectrum® Autos de Pasajeros Amortiguador	
Monroe® Monro-Matic Hidraulico Amortiguador		Chevrolet — Pickup C y R	73-87 T	Honda — Civic	06-11 T
Chevrolet — S-10	83-05 D	Chevrolet — Suburban	73-91 T		(Pág. 84)
GMC — Sonoma 2WD	83-93 D	Chevrolet — Van 1500 Express, Savana, Modelos G y P	73-89 T	Monroe® OESpectrum® Autos de Pasajeros Amortiguador	
<b>1406</b>	(Pág. 63-64, 71-72, 74)	Dina — 1000, 3000	78-86 T	Honda — Civic	12-15 TD
Monroe® Monro-Matic Hidraulico Amortiguador		GMC — Pickup Series C, R, K y V	73-87 T		12-15 TI
Ford — Bronco	80-96 D	<b>1419</b>	(Pág. 78)	<b>5507</b>	(Pág. 24, 119-120, 136)
Ford — Pickup Serie F-100, F-150, Lobo	80-96 D	Monroe® Monro-Matic Hidraulico Amortiguador		Monroe® OESpectrum® Autos de Pasajeros Amortiguador	
Ford — Pickup Serie F-250	80-86 D	Ford — Van Serie E	75-91 D	Seat — Ibiza	10-17 T
Ford — Pickup Serie F-350	80-86 D	<b>1420</b>	(Pág. 71)	Seat — Nuevo Ibiza	01-02 T
<b>1407</b>	(Pág. 63-64, 71-74)	Monroe® Monro-Matic Hidraulico Amortiguador		Seat — Toledo	13-19 T
Monroe® Monro-Matic Hidraulico Amortiguador		Ford — Pickup Serie F-100, F-150, Lobo	70-79 D	<b>5510</b>	(Pág. 57)
Ford — Bronco	80-96 T	<b>1538</b>	(Pág. 134, 137)	Monroe® OESpectrum® Autos de Pasajeros Amortiguador	
Ford — Pickup Serie F-100, F-150, Lobo	85-96 T	Monroe® Monro-Matic Hidraulico Amortiguador		Dodge — i10	12-14 TD
Ford — Pickup Serie F-250	80-91 T	Volkswagen — Brasilia	73-82 D		12-14 TI
Ford — Pickup Serie F-350	99-09 T	Volkswagen — Safari	73-80 D	<b>5511</b>	(Pág. 67)
	80-86 T	Volkswagen — Sedán	73-04 D	Monroe® OESpectrum® Autos de Pasajeros Amortiguador	
<b>1408</b>	(Pág. 109)	<b>2545</b>	(Pág. 137)	Ford — Fiesta	14-15 TD
Monroe® Monro-Matic Hidraulico Amortiguador		Monroe® Monro-Matic Hidraulico Amortiguador			14-15 TI
Nissan — Pickup	84-94 D	Volkswagen — Van Caravelle	72-95 T	<b>5512</b>	(Pág. 70)
Nissan — Pickup D-21	65-94 D	Volkswagen — Van Combi	72-01 T	Monroe® OESpectrum® Autos de Pasajeros Amortiguador	
<b>1409</b>	(Pág. 109)	Volkswagen — Van Panel	72-95 T	Ford — Mustang	15-17 T
Monroe® Monro-Matic Hidraulico Amortiguador		<b>2592</b>	(Pág. 137)	<b>5514</b>	(Pág. 49)
Nissan — Pickup	84-94 T	Monroe® Monro-Matic Hidraulico Amortiguador		Monroe® OESpectrum® Autos de Pasajeros Amortiguador	
Nissan — Pickup D-21	65-94 T	Volkswagen — Van Caravelle	72-95 D	Chrysler — 200	15-17 TD
<b>1412</b>	(Pág. 39, 47, 53, 71, 82, 93, 109, 112)	Volkswagen — Van Combi	72-01 D		15-17 TI
Monroe® Monro-Matic Hidraulico Amortiguador		Volkswagen — Van Panel	72-95 D	<b>5516</b>	(Pág. 28)
Chevrolet — Pickup C y R	63-72 T	<b>3116</b>	(Pág. 112)	Monroe® OESpectrum® Autos de Pasajeros Amortiguador	
Chevrolet — Van 1500 Express, Savana, Modelos G y P	63-66 T	Monroe® Monro-Matic Hidraulico Amortiguador		BMW — X5	14-18 TD
Dina — 1000, 3000	85-90 T	Nissan — Tsuru	84-87 TD		15-19 TD
Ford — Pickup Serie F-100, F-150, Lobo	70-79 T		84-87 TI		
GMC — Pickup Series C, R, K y V	63-72 T				

Números de parte con P (P--) indican accesorios con la unidad



# PROGRESIVO AMORTIGADORES

## INDICE PROGRESIVO DE APLICACIONES

Vehículo	Años Pos.	Vehículo	Años Pos.	Vehículo	Años Pos.
<b>5517</b>	(Pág. 28)	<b>5539</b>	(Pág. 31)	<b>5566</b>	(Pág. 133)
Monroe® OESpectrum® Autos de Pasajeros Amortiguador		Monroe® OESpectrum® Autos de Pasajeros Amortiguador		Monroe® OESpectrum®	
BMW — X5	14-18 TI	Cadillac — CTS	14-19 T	Toyota — Yaris	15-18 T
BMW — X6	15-19 TI		14-19 TD		(Pág. 108)
<b>5518</b>	(Pág. 137)		14-19 TI	<b>5600</b>	
Monroe® OESpectrum® Autos de Pasajeros Amortiguador		<b>5540</b>	(Pág. 99)	Monroe® OESpectrum® Autos de Pasajeros Amortiguador	
Volkswagen — Tiguan	09-17 T	Monroe® OESpectrum® Autos de Pasajeros Amortiguador		Nissan — Maxima	04-08 TD
<b>5521</b>	(Pág. 38)	Mazda — 3	14-18 TD		04-08 TI
Monroe® OESpectrum® Autos de Pasajeros Amortiguador			14-18 TI	<b>5602</b>	(Pág. 35)
Chevrolet — Malibu	08-09 TD	<b>5541</b>	(Pág. 96)	Monroe® OESpectrum® Autos de Pasajeros Amortiguador	
	08-09 TI	Monroe® OESpectrum® Autos de Pasajeros Amortiguador		Chevrolet — Corvette	97-04 D
<b>5522</b>	(Pág. 138)	Kia — Soul	14-19 TD		(Pág. 35)
Monroe® OESpectrum® Autos de Pasajeros Amortiguador			14-19 TI	<b>5603</b>	
Volvo — XC60	10-17 TD	<b>5543</b>	(Pág. 33)	Monroe® OESpectrum® Autos de Pasajeros Amortiguador	
	10-17 TI	Monroe® OESpectrum® Autos de Pasajeros Amortiguador		Chevrolet — Corvette	97-04 T
<b>5527</b>	(Pág. 133)	Chevrolet — Camaro	16-18 TD		(Pág. 63)
Monroe® OESpectrum® Autos de Pasajeros Amortiguador			16-18 TI	<b>5604</b>	
Volkswagen — Beetle	12-18 T	<b>5544</b>	(Pág. 129)	Monroe® OESpectrum® Amortiguador	
<b>5528</b>	(Pág. 135)	Monroe® OESpectrum® Autos de Pasajeros Amortiguador		Fiat — Palio	03-11 TD
Monroe® OESpectrum® Autos de Pasajeros Amortiguador		Toyota — Prius	16-17 TD		03-11 TI
Volkswagen — Jetta	15-18 T		16-17 TI	<b>5605</b>	(Pág. 87)
<b>5529</b>	(Pág. 136)	<b>5546</b>	(Pág. 100)	Monroe® OESpectrum® Autos de Pasajeros Amortiguador	
Monroe® OESpectrum® Autos de Pasajeros Amortiguador		Monroe® OESpectrum® Autos de Pasajeros Amortiguador		Honda — Fit	06-08 TD
Volkswagen — Passat	2012 T	Mazda — CX-5	17-19 T		06-08 TI
<b>5532</b>	(Pág. 110)		14-16 TD	<b>5606</b>	(Pág. 114)
Monroe® OESpectrum® Autos de Pasajeros Amortiguador			14-16 TI	Monroe® OESpectrum® Amortiguador	
Nissan — Sentra	14-19 TD	<b>5550</b>	(Pág. 87)	Peugeot — Partner	03-09 T
	14-19 TI	Monroe® OESpectrum® Autos de Pasajeros Amortiguador			(Pág. 99)
<b>5533</b>	(Pág. 67)	Honda — Insight	10-14 T	<b>5607</b>	
Monroe® OESpectrum® Amortiguador		<b>5551</b>	(Pág. 89)	Monroe® OESpectrum® Autos de Pasajeros Amortiguador	
Ford — Fiesta Ikon	11-15 TD	Monroe® OESpectrum® Autos de Pasajeros Amortiguador		Mazda — 3	04-09 TD
	11-15 TI	Hyundai — Sonata	15-19 T		04-09 TI
<b>5534</b>	(Pág. 114)		15-19 TD	Mazda — 5	12-15 TD
Monroe® OESpectrum® Amortiguador			15-19 TI		12-15 TI
Peugeot — 207	06-14 T	<b>5553</b>	(Pág. 135)		06-10 TD
<b>5536</b>	(Pág. 123)	Monroe® OESpectrum® Amortiguador			06-10 TI
Monroe® OESpectrum® Amortiguador		Volkswagen — Jetta	11-15 T	<b>5608</b>	(Pág. 137)
Suzuki — Swift	12-17 TD		(Pág. 123-124)	Monroe® OESpectrum® Amortiguador	
	12-17 TI	Monroe® OESpectrum® Autos de Pasajeros Amortiguador		Volkswagen — SportVan	06-10 T
<b>5537</b>	(Pág. 32, 43)	Toyota — Camry	18-19 T		(Pág. 85)
Monroe® OESpectrum® Autos de Pasajeros Amortiguador		<b>5556</b>	(Pág. 99-100)	<b>5609</b>	
Chevrolet — Spark	11-15 TD	Monroe® OESpectrum® Autos de Pasajeros Amortiguador		Monroe® OESpectrum® Autos de Pasajeros Amortiguador	
	11-15 TI	Mazda — 6	14-17 TD	Honda — Civic	06-11 TD
Chevrolet — Spark Classic	16-17 TD		14-17 TI		06-11 TI
	16-17 TI	<b>5558</b>	(Pág. 105)	<b>5611</b>	(Pág. 24, 133-136)
		Monroe® OESpectrum® Autos de Pasajeros Amortiguador		Monroe® OESpectrum® Autos de Pasajeros Amortiguador	
		Mitsubishi — Mirage	14-17 T	Audi — A3	05-13 T
				Volkswagen — Bora	05-11 T
				Volkswagen — CC	09-17 T
				Volkswagen — Golf SportWagen	10-13 T
				Volkswagen — GTi	06-14 T
				Volkswagen — Passat	06-10 T
				Volkswagen — Passat CC	09-12 T

Números de parte con P (P--) indican accesorios con la unidad



# PROGRESIVO AMORTIGUADORES

## INDICE PROGRESIVO DE APLICACIONES

Vehículo	Años Pos.	Vehículo	Años Pos.	Vehículo	Años Pos.
<b>5612</b> Monroe® OESpectrum® Autos de Pasajeros Amortiguador	(Pág. 49, 55) 05-10 T 06-10 T	<b>5622</b> Monroe® OESpectrum® Autos de Pasajeros Amortiguador	(Pág. 88) 07-10 TD 07-10 TI	<b>5646 (Cont.)</b> Monroe® OESpectrum® Autos de Pasajeros Amortiguador	(Pág. 88-89, 94) 12-14 TD 12-14 TI 11-15 T 14-16 T 12-15 TD 12-15 TI 11-15 T
<b>5613</b> Monroe® OESpectrum® Autos de Pasajeros Amortiguador	(Pág. 136) 01-03 T	<b>5624</b> Monroe® OESpectrum® Autos de Pasajeros Amortiguador	(Pág. 120, 129, 133) 08-10 TD 08-10 TI 16-19 T 12-15 TD 12-15 TI	<b>5647</b> Monroe® OESpectrum® Autos de Pasajeros Amortiguador	(Pág. 29-30, 36, 38) 10-15 TD 10-15 TI 13-15 TD 13-15 TI
<b>5614</b> Monroe® OESpectrum® Autos de Pasajeros Amortiguador	(Pág. 94) 07-09 T	<b>5626</b> Monroe® OESpectrum® Autos de Pasajeros Amortiguador	(Pág. 111) 07-18 TD 07-18 TI	<b>5648</b> Monroe® OESpectrum® Autos de Pasajeros Amortiguador	(Pág. 98) 09-12 TD 09-12 TI
<b>5615</b> Monroe® OESpectrum® Autos de Pasajeros Amortiguador	(Pág. 94-95) 06-10 TD 06-10 TI 06-10 TD 07-11 TD 07-11 TI	<b>5629</b> Monroe® OESpectrum® Autos de Pasajeros Amortiguador	(Pág. 49, 55-56) 05-10 T 09-10 T 06-10 T	<b>5652</b> Monroe® OESpectrum® Amortiguador	(Pág. 116) 04-05 TD 04-05 TI
<b>5616</b> Monroe® OESpectrum® Autos de Pasajeros Amortiguador	(Pág. 24-26) 08-13 TD 08-13 TI 08-13 TD 08-13 TI 06-13 TD 06-13 TI 07-13 TD 07-13 TI 06-07 TD 06-07 TI 07-15 TD 07-15 TI	<b>5630</b> Monroe® OESpectrum® Autos de Pasajeros Amortiguador	(Pág. 67, 99) 11-19 TD 11-19 TI 11-14 TD 11-14 TI	<b>5654</b> Monroe® OESpectrum® Autos de Pasajeros Amortiguador	(Pág. 90-91) 11-12 T 07-08 T 08-13 T
<b>5617</b> Monroe® OESpectrum® Autos de Pasajeros Amortiguador	(Pág. 137-138) 05-11 TD 05-11 TI 05-11 TD 05-11 TI	<b>5631</b> Monroe® OESpectrum® Autos de Pasajeros Amortiguador	(Pág. 90) 03-06 TD 03-06 TI	<b>5656</b> Monroe® OESpectrum® Autos de Pasajeros Amortiguador	(Pág. 100) 09-13 TD 09-13 TI
<b>5618</b> Monroe® OESpectrum® Autos de Pasajeros Amortiguador	(Pág. 119) 09-11 T 03-08 TD 03-08 TI	<b>5637</b> Monroe® OESpectrum® Autos de Pasajeros Amortiguador	(Pág. 105-106) 07-18 TD 07-18 TI	<b>5657</b> Monroe® OESpectrum® Autos de Pasajeros Amortiguador	(Pág. 96) 10-13 TD 10-13 TI
<b>5621</b> Monroe® OESpectrum® Autos de Pasajeros Amortiguador	(Pág. 53, 95) 06-11 TD 06-11 TI	<b>5639</b> Monroe® OESpectrum® Autos de Pasajeros Amortiguador	(Pág. 110) 07-12 TD 07-12 TI	<b>5658</b> Monroe® OESpectrum® Autos de Pasajeros Amortiguador	(Pág. 106) 09-14 TD 09-14 TI
		<b>5645</b> Monroe® OESpectrum® Autos de Pasajeros Amortiguador	(Pág. 68-69) 12-18 TD 12-18 TI	<b>5659</b> Monroe® OESpectrum® Autos de Pasajeros Amortiguador	(Pág. 32, 108) 00-08 T 00-08 TD 00-08 TI 09-14 TD 09-14 TI
		<b>5646</b> Monroe® OESpectrum® Autos de Pasajeros Amortiguador	(Pág. 88-89, 94) 12-17 T	<b>5660</b> Monroe® OESpectrum® Amortiguador	(Pág. 106, 118-119) 07-10 T 10-18 T

Números de parte con P (P--) indican accesorios con la unidad



# PROGRESIVO AMORTIGUADORES

## INDICE PROGRESIVO DE APLICACIONES

Vehículo	Años Pos.	Vehículo	Años Pos.	Vehículo	Años Pos.
<b>5660 (Cont.)</b>	(Pág. 106, 118-119)	<b>5675</b>	(Pág. 120)	<b>5689</b>	(Pág. 30)
Monroe® OESpectrum® Amortiguador		Monroe® OESpectrum® Autos de Pasajeros		Monroe® OESpectrum® Autos de Pasajeros	
Renault — Stepway	10-14 T	Amortiguador		Amortiguador	
<b>5661</b>	(Pág. 38, 116)	Scion — xD	11-14 TD	Buick — Verano	12-17 TD
Monroe® OESpectrum® Amortiguador			11-14 TI		12-17 TI
Chevrolet — Matiz	11-15 TD	<b>5677</b>	(Pág. 28)	<b>5695</b>	(Pág. 49)
	11-15 TI	Monroe® OESpectrum® Autos de Pasajeros		Monroe® OESpectrum® Amortiguador	
Pontiac — Matiz	06-10 TD	Amortiguador		Chrysler — AtoS	00-12 TD
	06-10 TI	BMW — Z4	03-08 T		00-12 TI
<b>5662</b>	(Pág. 30)	<b>5678</b>	(Pág. 68)	<b>5697</b>	(Pág. 99)
Monroe® OESpectrum® Autos de Pasajeros		Monroe® OESpectrum® Autos de Pasajeros		Monroe® OESpectrum® Autos de Pasajeros	
Amortiguador		Amortiguador		Amortiguador	
Buick — Regal	15-17 T	Ford — Focus	17-18 T	Mazda — 3	10-11 TD
	11-17 TD		13-16 TD		10-11 TI
	11-17 TI		13-16 TI	<b>5698</b>	(Pág. 85)
<b>5663</b>	(Pág. 35-36)	<b>5681</b>	(Pág. 24-26)	Monroe® OESpectrum® Autos de Pasajeros	
Monroe® OESpectrum® Autos de Pasajeros		Monroe® OESpectrum® Autos de Pasajeros		Amortiguador	
Amortiguador		Amortiguador		Honda — Civic	12-15 TD
Chevrolet — Cruze	10-15 TD	BMW — 128	08-13 TD		12-15 TI
	10-15 TI		08-13 TI	<b>5778</b>	(Pág. 35, 38, 115)
<b>5664</b>	(Pág. 30)	BMW — 135	08-13 TD	Monroe® OESpectrum® Autos de Pasajeros	
Monroe® OESpectrum® Autos de Pasajeros			08-13 TI	Amortiguador	
Amortiguador		BMW — 328i (E90)	07-13 TD	Chevrolet — Corsa	01-08 TD
Cadillac — ATS	13-18 T		07-13 TI		01-08 TI
	13-18 TD	BMW — 335i (E90, 92, 93)	07-13 TD	Chevrolet — Malibu	08-12 TD
	13-18 TI		07-13 TI		08-12 TI
<b>5666</b>	(Pág. 138)	<b>5682</b>	(Pág. 84, 86)	Pontiac — G6	05-10 TD
Monroe® OESpectrum® Autos de Pasajeros		Monroe® OESpectrum® Autos de Pasajeros			05-10 TI
Amortiguador		Amortiguador		<b>5779</b>	(Pág. 36, 115)
Volvo — S80	06-15 TD	Honda — City	09-14 T	Monroe® OESpectrum® Autos de Pasajeros	
	06-15 TI	Honda — Fit	09-14 T	Amortiguador	
<b>5668</b>	(Pág. 119)	<b>5683</b>	(Pág. 99)	Chevrolet — HHR	06-11 T
Monroe® OESpectrum® Autos de Pasajeros		Monroe® OESpectrum® Autos de Pasajeros		Pontiac — G5	07-09 T
Amortiguador		Amortiguador			(Pág. 38)
Saturn — Ion	03-06 T	Mazda — 3	12-13 TD	Monroe® OESpectrum® Autos de Pasajeros	
<b>5671</b>	(Pág. 88-89, 94-95)		12-13 TI	Amortiguador	
Monroe® OESpectrum® Autos de Pasajeros		<b>5684</b>	(Pág. 120)	Chevrolet — Malibu	04-07 TD
Amortiguador		Monroe® OESpectrum® Autos de Pasajeros			04-07 TI
Hyundai — Elantra	13-17 T	Amortiguador		<b>5781</b>	(Pág. 119, 137)
	11-16 TD	Scion — tC	11-16 TD	Monroe® OESpectrum® Amortiguador	
	11-16 TI		11-16 TI	Seat — Alhambra	02-08 T
Hyundai — Veloster	12-15 T	<b>5685</b>	(Pág. 129)	Volkswagen — Sharan	02-08 T
Kia — Forte	14-18 T	Monroe® OESpectrum® Autos de Pasajeros			(Pág. 70)
Kia — Rio	12-15 TD	Amortiguador		Monroe® OESpectrum® Autos de Pasajeros	
	12-15 TI	Toyota — Prius	10-15 TD	Amortiguador	
<b>5672</b>	(Pág. 53, 94)		10-15 TI	Ford — Mustang	05-14 T
Monroe® OESpectrum® Autos de Pasajeros		<b>5687</b>	(Pág. 120)		(Pág. 69, 98-100)
Amortiguador		Monroe® OESpectrum® Autos de Pasajeros		<b>5784</b>	
Dodge — Attitude	12-14 TD	Amortiguador		Monroe® OESpectrum® Autos de Pasajeros	
	12-14 TI	Scion — xB	08-15 TD	Amortiguador	
Kia — Forte	10-13 TD		08-15 TI	Ford — Fusion	06-12 T
	10-13 TI	<b>5688</b>	(Pág. 123)	Lincoln — MKZ	07-12 T
<b>5673</b>	(Pág. 108, 112)	Monroe® OESpectrum® Autos de Pasajeros		Mazda — 6i	03-08 T
Monroe® OESpectrum® Autos de Pasajeros		Amortiguador		Mazda — 6S	03-08 T
Amortiguador		Suzuki — SX4	07-14 T		(Pág. 35)
Nissan — Note	14-19 TD			<b>5785</b>	
	14-19 TI			Monroe® OESpectrum® Amortiguador	
Nissan — Versa	12-13 TD			Chevrolet — Corsa	01-08 TD
	12-13 TI				01-08 TI

Números de parte con P (P--) indican accesorios con la unidad





# PROGRESIVO AMORTIGUADORES

## INDICE PROGRESIVO DE APLICACIONES

Vehículo	Años Pos.	Vehículo	Años Pos.	Vehículo	Años Pos.
<b>5786</b>	(Pág. 116)	<b>5802 (Cont.)</b>	(Pág. 31, 33-34, 37-38, 113, 116)	<b>5831</b>	(Pág. 33)
Monroe® OESpectrum® Autos de Pasajeros Amortiguador		Monroe® OESpectrum® Autos de Pasajeros Amortiguador		Monroe® OESpectrum® Autos de Pasajeros Amortiguador	
Pontiac — GTO	04-06 T	Oldsmobile — Cutlass	68-88 T	Chevrolet — Camaro	70-81 T
<b>5791</b>	(Pág. 119, 136)	Oldsmobile — Cutlass Supreme	78-87 T	<b>5837</b>	(Pág. 50, 53, 57-58, 114-115)
Monroe® OESpectrum® Amortiguador		Pontiac — Grand Prix	73-87 T	Monroe® OESpectrum® Autos de Pasajeros Amortiguador	
Seat — Cordoba	03-09 T	Pontiac — Le Mans	73-83 T	Chrysler — H-100	81-83 T
Seat — Ibiza	03-09 T	<b>5803</b>	(Pág. 23, 69-70, 102, 106)	Chrysler — LeBaron	77-81 T
Volkswagen — Lupo	03-09 T	Monroe® OESpectrum® Autos de Pasajeros Amortiguador		Dodge — Aspen	76-80 T
Volkswagen — Polo	03-08 T	American Motors (rambler) — AMX	71-74 T	Dodge — Dart	77-89 T
<b>5792</b>	(Pág. 118)	American Motors (rambler) — Javelin	70-74 T	Dodge — Diplomat	79-89 T
Monroe® OESpectrum® Amortiguador		Ford — Galaxie	65-74 T	Dodge — Magnum	78-79 T
Renault — Kangoo	07-09 T	Ford — LTD	67-82 T	Plymouth — Caravelle	77-89 T
Renault — Kangoo Express	04-12 T	Mercury — Grand Marquis	83-91 T	Plymouth — Volare	76-80 T
<b>5794</b>	(Pág. 32, 115)	Nissan — Datsun	74-77 T	<b>5840</b>	(Pág. 31, 34, 38, 106, 113, 116)
Monroe® OESpectrum® Autos de Pasajeros Amortiguador		<b>5809</b>	(Pág. 23, 67, 77)	Monroe® OESpectrum® Autos de Pasajeros Amortiguador	
Chevrolet — Aveo	04-18 TD	Monroe® OESpectrum® Autos de Pasajeros Amortiguador		Cadillac — Seville	76-79 D
Pontiac — G3	06-09 TD	American Motors (rambler) — AMX	78-80 D	Chevrolet — Chevelle	68-77 D
	06-09 TI	AMX	71-74 D	Chevrolet — Chevy Nova	75-79 D
<b>5795</b>	(Pág. 90, 105)	American Motors (rambler) — Gremlin	71-78 D	Chevrolet — Monte Carlo	73-88 D
Monroe® OESpectrum® Autos de Pasajeros Amortiguador		American Motors (rambler) — Javelin	70-74 D	Nissan — Datsun	64-69 D
Infiniti — G35	03-05 T	Ford — Fairline y Fairline 500	66-70 D	Oldsmobile — Cutlass	68-88 D
Nissan — 350 Z	03-05 T	Ford — Falcon	66-70 D	Oldsmobile — Cutlass Supreme	78-87 D
<b>5796</b>	(Pág. 69)	Ford — Torino y Gran Torino	68-71 D	Pontiac — Grand Prix	73-87 D
Monroe® OESpectrum® Autos de Pasajeros Amortiguador		<b>5818</b>	(Pág. 23, 67, 70, 76, 106)	Pontiac — Le Mans	73-83 D
Ford — Focus	00-11 TD	Monroe® OESpectrum® Autos de Pasajeros Amortiguador		<b>5847</b>	(Pág. 67, 71, 102-103)
	00-11 TI	American Motors (rambler) — American	64-69 T	Monroe® OESpectrum® Autos de Pasajeros Amortiguador	
<b>5797</b>	(Pág. 49, 55-56)	Ford — Fairline y Fairline 500	66-70 T	Ford — Fairline y Fairline 500	78-83 T
Monroe® OESpectrum® Autos de Pasajeros Amortiguador		Ford — Falcon	66-70 T	Ford — Mustang	85-93 T
Chrysler — 300, 300C y 300M	05-10 T	Ford — LTD II	77-79 T	Mercury — Capri y Capri II	79-86 T
Dodge — Challenger	11-19 T	Ford — Rancho	72-79 T	Mercury — Zephyr	78-83 T
Dodge — Charger	06-10 T	Nissan — Datsun	64-74 T	<b>5850</b>	(Pág. 35)
<b>5801</b>	(Pág. 31, 33, 37, 64, 67, 69, 70, 76, 102)	<b>5819</b>	(Pág. 23)	Monroe® OESpectrum® Autos de Pasajeros Amortiguador	
Monroe® OESpectrum® Autos de Pasajeros Amortiguador		Monroe® OESpectrum® Autos de Pasajeros Amortiguador		Chevrolet — Corvette	62-82 T
Cadillac — DeVille	77-90 D	American Motors (rambler) — American	64-69 D	<b>5861</b>	(Pág. 77, 102)
Chevrolet — Camaro	70-81 D	<b>5827</b>	(Pág. 56-57)	Monroe® OESpectrum® Autos de Pasajeros Amortiguador	
Chevrolet — Caprice	66-81 D	Monroe® OESpectrum® Autos de Pasajeros Amortiguador		Ford — Thunderbird	80-88 T
Chevrolet — Impala	65-85 D	Dodge — Dart	13-16 TD	Mercury — Cougar	83-88 T
Ford — Crown Victoria	83-91 D		13-16 TI	<b>5867</b>	(Pág. 33, 115)
Ford — Fairline y Fairline 500	57-61 D	<b>5829</b>	(Pág. 50, 53, 57, 114-115)	Monroe® OESpectrum® Autos de Pasajeros Amortiguador	
Ford — Galaxie	65-74 D	Monroe® OESpectrum® Autos de Pasajeros Amortiguador		Chevrolet — Camaro	82-02 T
Ford — LTD	67-82 D	Chrysler — H-100	81-83 D	Pontiac — Firebird	93-02 TD
Ford — LTD II	77-79 D	Chrysler — LeBaron	77-81 D		93-02 TI
Ford — Rancho	72-79 D	Dodge — Aspen	76-80 D	<b>5892</b>	(Pág. 35)
Mercury — Grand Marquis	83-91 D	Dodge — Dart	77-89 D	Monroe® OESpectrum® Autos de Pasajeros Amortiguador	
<b>5802</b>	(Pág. 31, 33-34, 37-38, 113, 116)	Dodge — Diplomat	79-89 D	Chevrolet — Corvette	84-96 D
Monroe® OESpectrum® Autos de Pasajeros Amortiguador		Plymouth — Caravelle	77-89 D	<b>5893</b>	(Pág. 35)
Cadillac — DeVille	77-90 T	Plymouth — Volare	76-80 D	Monroe® OESpectrum® Autos de Pasajeros Amortiguador	
Chevrolet — Caprice	66-81 T			Chevrolet — Corvette	84-87 T
Chevrolet — Chevelle	68-77 T				
Chevrolet — Impala	65-81 T				
Chevrolet — Monte Carlo	73-88 T				

Números de parte con P (P--) indican accesorios con la unidad



# PROGRESIVO AMORTIGUADORES

## INDICE PROGRESIVO DE APLICACIONES

Vehículo	Años Pos.	Vehículo	Años Pos.	Vehículo	Años Pos.
<b>5896</b>	(Pág. 30, 32, 34-35, 113, 116)	<b>5962 (Cont.)</b>	(Pág. 50-51, 57, 62, 114-115)	<b>5986</b>	(Pág. 69)
Monroe® OESpectrum® Autos de Pasajeros Amortiguador		Monroe® OESpectrum® Autos de Pasajeros Amortiguador		Monroe® OESpectrum® Autos de Pasajeros Amortiguador	
Cadillac — Cimarron	83-88 T	Chrysler — New Yorker y Fifth Avenue	86-87 T	Ford — Focus	00-07 TD
Chevrolet — Beretta	87-94 T	Dodge — Daytona	86-93 T		00-07 TI
Chevrolet — Cavalier	84-94 T	Dodge — Shadow	89-94 T	<b>5988</b>	(Pág. 25-26)
Chevrolet — Corsica	87-94 T	Dodge — Spirit	89-95 T	Monroe® OESpectrum® Autos de Pasajeros Amortiguador	
Oldsmobile — Calais	85-91 TD	Plymouth — Acclaim	89-95 T	BMW — 325i	01-05 TD
	85-91 TI	Plymouth — Sundance	87-94 T		01-05 TI
Pontiac — Grand Am	85-94 T	<b>5965</b>	(Pág. 77, 102)	BMW — 330i	01-05 TD
<b>5897</b>	(Pág. 29, 34, 113)	Monroe® OESpectrum® Autos de Pasajeros Amortiguador			01-05 TI
Monroe® OESpectrum® Autos de Pasajeros Amortiguador		Ford — Thunderbird	92-97 T	<b>5989</b>	(Pág. 51)
Buick — Century	82-96 T	Mercury — Cougar	92-97 T	Monroe® OESpectrum® Autos de Pasajeros Amortiguador	
Chevrolet — Celebrity	82-90 T	<b>5966</b>	(Pág. 37)	Chrysler — PT Cruiser	01-10 T
Chevrolet — Citation	82-84 T	Monroe® OESpectrum® Autos de Pasajeros Amortiguador		<b>5990</b>	(Pág. 106)
Oldsmobile — Cutlass Ciera	82-96 T	Chevrolet — Impala	94-96 T	Monroe® OESpectrum® Autos de Pasajeros Amortiguador	
Oldsmobile — Eurosport	85-90 T	<b>5967</b>	(Pág. 64)	Nissan — Altima	02-06 TD
Oldsmobile — Omega	80-84 T	Monroe® OESpectrum® Autos de Pasajeros Amortiguador			02-06 TI
<b>5906</b>	(Pág. 35, 37)	Ford — Crown Victoria	93-02 T	<b>5992</b>	(Pág. 119)
Monroe® OESpectrum® Autos de Pasajeros Amortiguador		<b>5968</b>	(Pág. 71)	Monroe® OESpectrum® Autos de Pasajeros Amortiguador	
Chevrolet — Corvette	62-82 D	Monroe® OESpectrum® Autos de Pasajeros Amortiguador		Saab — 9-5	99-06 T
Chevrolet — Impala	94-96 D	Ford — Mustang	94-04 T	<b>5993</b>	(Pág. 64, 70, 99)
<b>5931</b>	(Pág. 34)	<b>5969</b>	(Pág. 64)	Monroe® OESpectrum® Autos de Pasajeros Amortiguador	
Monroe® OESpectrum® Autos de Pasajeros Amortiguador		Monroe® OESpectrum® Autos de Pasajeros Amortiguador		Ford — Crown Victoria	03-11 T
Chevrolet — Chevy Nova	75-79 T	Ford — Crown Victoria	93-02 D	Ford — Grand Marquis	03-11 T
<b>5939</b>	(Pág. 35)	<b>5970</b>	(Pág. 32, 35, 116)	Lincoln — Town Car	03-11 T
Monroe® OESpectrum® Autos de Pasajeros Amortiguador		Monroe® OESpectrum® Autos de Pasajeros Amortiguador		<b>5996</b>	(Pág. 24)
Chevrolet — Corvette	88-96 T	Chevrolet — Corsica	95-96 T	Monroe® OESpectrum® Autos de Pasajeros Amortiguador	
<b>5948</b>	(Pág. 50-51)	Pontiac — Grand Am	96-98 T	Audi — TT	00-06 T
Monroe® OESpectrum® Autos de Pasajeros Amortiguador		<b>5971</b>	(Pág. 103)	<b>5998</b>	(Pág. 25)
Chrysler — Dynasty	88-93 T	Monroe® OESpectrum® Autos de Pasajeros Amortiguador		Monroe® OESpectrum® Autos de Pasajeros Amortiguador	
Chrysler — New Yorker y Fifth Avenue	88-93 T	Mercury — Sable	96-06 T	BMW — 323i	99-00 TD
<b>5955</b>	(Pág. 37)	<b>5974</b>	(Pág. 25)		99-00 TI
Monroe® OESpectrum® Autos de Pasajeros Amortiguador		Monroe® OESpectrum® Autos de Pasajeros Amortiguador		<b>5999</b>	(Pág. 28)
Chevrolet — Impala	82-85 T	BMW — 325i	95-97 TD	Monroe® OESpectrum® Autos de Pasajeros Amortiguador	
<b>5960</b>	(Pág. 64, 70, 99)		95-97 TI	BMW — Z3	96-02 T
Monroe® OESpectrum® Autos de Pasajeros Amortiguador		<b>5975</b>	(Pág. 138)	<b>31000</b>	(Pág. 39, 47, 53, 82, 93, 107, 109, 112)
Ford — Crown Victoria	93-02 D	Monroe® OESpectrum® Autos de Pasajeros Amortiguador		Monroe® Monro-Matic Plus® Amortiguador	
Ford — Grand Marquis	01-02 D	Volvo — C70	98-04 T	Chevrolet — Pickup C y R	63-72 T
Lincoln — Town Car	86-02 D	<b>5984</b>	(Pág. 24, 119-120, 133, 135-136)	Chevrolet — Van 1500 Express, Savana, Modelos G y P	68-72 T
<b>5961</b>	(Pág. 64, 70, 99)	Monroe® OESpectrum® Autos de Pasajeros Amortiguador		Dina — 1000, 3000	63-66 T
Monroe® OESpectrum® Autos de Pasajeros Amortiguador		Audi — A3	98-04 T	Dina — 1000, 3000	85-90 T
Ford — Crown Victoria	93-02 T	Seat — León	01-13 T	GMC — Pickup Series C, R, K y V	63-72 T
	83-91 T	Seat — Toledo	01-08 T	Jeep — Pickup S	66-84 D
Ford — Grand Marquis	01-02 T	Volkswagen — Beetle	98-11 T		66-84 T
Lincoln — Town Car	86-02 T	Volkswagen — Golf A4	99-07 T	Nissan — Frontier Pickup	98-03 T
<b>5962</b>	(Pág. 50-51, 57, 62, 114-115)	Volkswagen — Jetta A4	99-10 T	Nissan — Pickup	95-09 T
Monroe® OESpectrum® Autos de Pasajeros Amortiguador		Volkswagen — Jetta Clasico	11-15 T	Nissan — Pickup D-21	65-94 T
Chrysler — LeBaron	89-95 T			Nissan — Van Urvan	98-03 T

Números de parte con P (P--) indican accesorios con la unidad



# PROGRESIVO AMORTIGUADORES

## INDICE PROGRESIVO DE APLICACIONES

Vehículo	Años Pos.	Vehículo	Años Pos.	Vehículo	Años Pos.
<b>31069</b>	(Pág. 67, 71)	<b>32066 (Cont.)</b>	(Pág. 31-33, 37, 64, 67, 69, 70, 76, 102)	<b>32134</b>	(Pág. 56, 58, 115)
Monroe® Monro-Matic Plus® Amortiguador		Monroe® Monro-Matic Plus® Amortiguador		Monroe® Monro-Matic Plus® Amortiguador	
Ford — Fairline y Fairline 500	62-70 T	Chevrolet — Camaro	70-81 D	Dodge — Charger	73-76 D
Ford — Mustang	65-70 T	Chevrolet — Caprice	66-81 D	Dodge — Coronet	73-76 D
<b>31089</b>	(Pág. 134, 137)	Chevrolet — Impala	65-81 D	Dodge — Magnum	78-79 D
Monroe® Monro-Matic Plus® Amortiguador		Ford — Crown Victoria	83-91 D	Plymouth — Roadrunner	73-75 D
Volkswagen — Brasilia	73-82 T	Ford — Fairline y Fairline 500	57-61 D	<b>32186</b>	(Pág. 32-33, 43, 79, 83)
Volkswagen — Safari	73-80 T	Ford — Galaxie	65-74 D	Monroe® Monro-Matic Plus® Amortiguador	
Volkswagen — Sedán	53-04 T	Ford — LTD	67-82 D	Chevrolet — Blazer	83-05 T
	53-72 D	Ford — LTD II	77-79 D	Chevrolet — S-10	82-05 T
<b>31094</b>	(Pág. 37, 91, 107, 109)	Ford — Ranchero	72-79 D	GMC — Envoy	98-01 T
Monroe® Monro-Matic Plus® Amortiguador		Mercury — Grand Marquis	83-91 D	GMC — Sonoma 2WD	82-05 T
Chevrolet — Luv Pickup	97-06 T	<b>32073</b>	(Pág. 55-56, 58, 114-115)	<b>32191</b>	(Pág. 71)
	81-83 T	Monroe® Monro-Matic Plus® Amortiguador		Monroe® Monro-Matic Plus® Amortiguador	
Isuzu — Amigo	89-95 T	Dodge — Challenger	70-74 T	Ford — Mustang	74-78 T
Isuzu — Pickup	89-95 T	Dodge — Charger	66-76 T		(Pág. 33, 43, 79, 83)
Nissan — Frontier Pickup	98-04 T	Dodge — Coronet	62-76 T	<b>32194</b>	
Nissan — Pickup 720	83-86 T	Dodge — Mónaco	74-76 T	Monroe® Monro-Matic Plus® Amortiguador	
<b>31125</b>	(Pág. 31)	Plymouth — Barracuda	70-74 T	Chevrolet — Blazer	83-05 D
Monroe® Monro-Matic Plus® Amortiguador		Plymouth — Roadrunner	73-75 T	Chevrolet — S-10	83-05 D
Cadillac — Eldorado	55-64 T	<b>32075</b>	(Pág. 71, 74, 78)	GMC — Envoy	98-01 D
<b>31131</b>	(Pág. 57, 61-62, 114)	Monroe® Monro-Matic Plus® Amortiguador		GMC — Sonoma 2WD	82-05 D
Monroe® Monro-Matic Plus® Amortiguador		Ford — Pickup Serie F-100, F-150, Lobo	70-79 D	<b>32196</b>	(Pág. 92-94)
Dodge — Dart	63-76 T	Ford — Pickup Serie F-350	67-79 D	Monroe® Monro-Matic Plus® Amortiguador	
Dodge — Pickup D y W	61-71 T	Ford — Van Serie E	75-91 D	Jeep — Cherokee	84-90 D
Dodge — Ramcharger	74-93 D	<b>32080</b>	(Pág. 71, 74)	Jeep — Wagoneer (Grand Wagoneer)	84-90 D
Plymouth — Barracuda	64-69 T	Monroe® Monro-Matic Plus® Amortiguador		Jeep — Wrangler	96-06 D
Plymouth — Duster	60-76 T	Ford — Pickup Serie F-100, F-150, Lobo	70-79 T	<b>32197</b>	(Pág. 92-93)
<b>31162</b>	(Pág. 109)	Ford — Pickup Serie F-350	74-79 T	Monroe® Monro-Matic Plus® Amortiguador	
Monroe® Monro-Matic Plus® Amortiguador		<b>32113</b>	(Pág. 37, 107, 109)	Jeep — Cherokee	84-01 T
Nissan — Pickup 720	83-86 T	Monroe® Monro-Matic Plus® Amortiguador		Jeep — Wagoneer (Grand Wagoneer)	84-90 T
<b>31176</b>	(Pág. 50, 53, 57-58, 115)	Chevrolet — Luv Pickup	81-82 D		(Pág. 37, 107, 109)
Monroe® Monro-Matic Plus® Amortiguador		Nissan — Frontier Pickup	98-02 D	<b>32206</b>	
Chrysler — H-100	81-83 D	Nissan — Pickup	95-97 D	Monroe® Monro-Matic Plus® Amortiguador	
Dodge — Aspen	76-80 D	Nissan — Pickup D-21	65-94 D	Chevrolet — Luv Pickup	97-06 D
Dodge — Dart	77-89 D	<b>32118</b>	(Pág. 71)		81-83 D
Dodge — Mónaco	74-76 D	Monroe® Monro-Matic Plus® Amortiguador		Nissan — Frontier Pickup	98-04 D
Plymouth — Volare	76-80 D	Ford — Mustang	74-78 D	Nissan — Pickup	95-97 D
<b>31197</b>	(Pág. 109, 118)	<b>32127</b>	(Pág. 61-62)	Nissan — Pickup 720	83-86 D
Monroe® Monro-Matic Plus® Amortiguador		Monroe® Monro-Matic Plus® Amortiguador		<b>32212</b>	(Pág. 32)
Nissan — Platina	02-10 T	Dodge — Pickup D y W	72-93 D	Monroe® Monro-Matic Plus® Amortiguador	
Renault — Clio	01-10 T	Dodge — Ramcharger	75-93 D	Chevrolet — Astro (Mini Van)	85-05 T
<b>31538</b>	(Pág. 134, 137)	<b>32132</b>	(Pág. 31-32, 34, 38, 43, 63, 106, 113, 116)	<b>32214</b>	(Pág. 56)
Monroe® Monro-Matic Plus® Amortiguador		Monroe® Monro-Matic Plus® Amortiguador		Monroe® Monro-Matic Plus® Amortiguador	
Volkswagen — Brasilia	73-82 D	Cadillac — Seville	76-79 D	Dodge — Dakota	87-96 D
Volkswagen — Safari	73-80 D	Chevrolet — Blazer	83-93 D	<b>32215</b>	(Pág. 56)
Volkswagen — Sedán	73-04 D	Chevrolet — Chevelle	73-77 D	Monroe® Monro-Matic Plus® Amortiguador	
<b>32022</b>	(Pág. 55-57, 114)	Chevrolet — Chevy Nova	75-79 D	Dodge — Dakota	87-96 T
Monroe® Monro-Matic Plus® Amortiguador		Chevrolet — Monte Carlo	73-88 D	<b>32217</b>	(Pág. 91)
Dodge — Challenger	70-74 D	Chevrolet — S-10	82-93 D	Monroe® Monro-Matic Plus® Amortiguador	
Dodge — Charger	66-72 D	Ford — Aerostar (Mini) Van	86-97 D	Isuzu — Amigo	89-95 D
Dodge — Coronet	62-72 D	Nissan — Datsun	64-69 D	Isuzu — Pickup	89-95 D
Dodge — Dart	63-76 D	Oldsmobile — Cutlass	68-88 D	Isuzu — Rodeo	91-95 D
Plymouth — Barracuda	64-74 D	Oldsmobile — Cutlass Supreme	78-87 D	Isuzu — Trooper	87-91 D
Plymouth — Duster	60-76 D	Pontiac — Grand Prix	73-87 D	<b>32224</b>	(Pág. 39, 44, 47-48, 81-82)
<b>32066</b>	(Pág. 31-33, 37, 64, 67, 69, 70, 76, 102)	Pontiac — Le Mans	73-83 D	Monroe® Monro-Matic Plus® Amortiguador	
Monroe® Monro-Matic Plus® Amortiguador				Chevrolet — Pickup C y R	87-00 D
Cadillac — DeVille	77-90 D			Chevrolet — Suburban	92-99 D
Chevrolet — Astro (Mini Van)	85-05 D				

Números de parte con P (P--) indican accesorios con la unidad



# PROGRESIVO AMORTIGUADORES

## INDICE PROGRESIVO DE APLICACIONES

Vehículo	Años Pos.	Vehículo	Años Pos.	Vehículo	Años Pos.
<b>32224</b> (Cont.)	(Pág. 39, 44, 47-48, 81-82)	<b>32251</b>	(Pág. 56)	<b>32275</b>	(Pág. 78)
Monroe® Monro-Matic Plus® Amortiguador		Monroe® Monro-Matic Plus® Amortiguador		Monroe® Monro-Matic Plus® Amortiguador	
Chevrolet — Van 1500 Express, Savana, Modelos G y P	96-02 D	Dodge — Dakota	87-96 T	Ford — Windstar (Mini Van)	94-03 T
Chevrolet — Van Cargo Van	97-00 D	<b>32252</b>	(Pág. 92-93)	<b>32277</b>	(Pág. 59-60)
GMC — Pickup Series C, R, K y V	87-02 D	Monroe® Monro-Matic Plus® Amortiguador		Monroe® Monro-Matic Plus® Amortiguador	
<b>32225</b>	(Pág. 39-40, 81-82)	Jeep — Cherokee	91-01 D	Dodge — Pickup Ram 1500	94-01 D
Monroe® Monro-Matic Plus® Amortiguador		Jeep — Grand Cherokee	93-98 D	Dodge — Pickup Ram 2500	94-02 D
Chevrolet — Pickup K y V	87-00 T	<b>32253</b>	(Pág. 66-67)	Dodge — Pickup Ram 3500	94-02 D
Chevrolet — Pickup C y R	87-00 T	Monroe® Monro-Matic Plus® Amortiguador		<b>32278</b>	(Pág. 59-60)
GMC — Pickup Series C, R, K y V	87-02 T	Ford — Explorer	91-06 T	Monroe® Monro-Matic Plus® Amortiguador	
<b>32227</b>	(Pág. 63-64, 71-74)	<b>32254</b>	(Pág. 32)	Dodge — Pickup Ram 1500	94-01 T
Monroe® Monro-Matic Plus® Amortiguador		Monroe® Monro-Matic Plus® Amortiguador		Dodge — Pickup Ram 2500	94-02 T
Ford — Bronco	80-96 D	Chevrolet — Astro (Mini Van)	90-05 D	Dodge — Pickup Ram 3500	94-02 T
Ford — Pickup Serie F-100, F-150, Lobo	80-96 D	<b>32259</b>	(Pág. 78)	<b>32279</b>	(Pág. 59)
Ford — Pickup Serie F-250	80-86 D	Monroe® Monro-Matic Plus® Amortiguador		Monroe® Monro-Matic Plus® Amortiguador	
Ford — Pickup Serie F-350	80-86 D	Ford — Club Wagon	97-98 D	Dodge — Pickup Ram 1500	94-01 D
<b>32231</b>	(Pág. 72-74)	Ford — Van Econoline	10-14 D	Dodge — Pickup Ram 2500	94-02 D
Monroe® Monro-Matic Plus® Amortiguador		Ford — Van Serie E	92-07 D	<b>32280</b>	(Pág. 72-73)
Ford — Pickup Serie F-250	80-96 T	<b>32260</b>	(Pág. 78)	Monroe® Monro-Matic Plus® Amortiguador	
Ford — Pickup Serie F-350	99-16 T	Monroe® Monro-Matic Plus® Amortiguador		Ford — Pickup Serie F-250	92-96 D
	80-91 T	Ford — Club Wagon	97-98 T	Ford — Pickup Serie F-350	92-98 D
<b>32233</b>	(Pág. 52, 55)	Ford — Van Econoline	10-14 T	<b>32284</b>	(Pág. 78)
Monroe® Monro-Matic Plus® Amortiguador		Ford — Van Serie E	92-07 T	Monroe® Monro-Matic Plus® Amortiguador	
Chrysler — Town & Country	90-95 T	<b>32263</b>	(Pág. 31, 39, 82-83)	Ford — Van Serie E	75-91 T
Chrysler — Voyager y Grand Voyager	84-94 T	Monroe® Monro-Matic Plus® Amortiguador		<b>32290</b>	(Pág. 52, 54-55)
Dodge — Caravan y Grand Caravan	86-95 T	Cadillac — Escalade	99-00 D	Monroe® Monro-Matic Plus® Amortiguador	
<b>32235</b>	(Pág. 66-67, 76)	Chevrolet — Pickup K y V	87-00 D	Chrysler — Town & Country	95-07 T
Monroe® Monro-Matic Plus® Amortiguador		GMC — Pickup Series C, R, K y V	87-00 D	Chrysler — Voyager y Grand Voyager	95-07 T
Ford — Explorer	91-94 D	GMC — Yukon	95-99 D	Dodge — Caravan y Grand Caravan	95-07 T
Ford — Ranger	90-97 D	<b>32264</b>	(Pág. 44, 47-48)	<b>32292</b>	(Pág. 132)
<b>32237</b>	(Pág. 76)	Monroe® Monro-Matic Plus® Amortiguador		Monroe® Monro-Matic Plus® Amortiguador	
Monroe® Monro-Matic Plus® Amortiguador		Chevrolet — Suburban	92-99 T	Toyota — Tacoma	95-04 D
Ford — Ranger	83-11 T	Chevrolet — Van 1500 Express, Savana, Modelos G y P	96-14 T	<b>32293</b>	(Pág. 132)
<b>32238</b>	(Pág. 76)	Chevrolet — Van Cargo Van	97-00 T	Monroe® Monro-Matic Plus® Amortiguador	
Monroe® Monro-Matic Plus® Amortiguador		<b>32267</b>	(Pág. 78)	Monroe® Monro-Matic Plus® Amortiguador	
Ford — Ranger	83-11 T	Monroe® Monro-Matic Plus® Amortiguador		Toyota — Tacoma	95-04 T
<b>32239</b>	(Pág. 72, 74-75)	Ford — Van Econoline	10-14 D	<b>32294</b>	(Pág. 132)
Monroe® Monro-Matic Plus® Amortiguador		Ford — Van Serie E	92-14 D	Monroe® Monro-Matic Plus® Amortiguador	
Ford — Pickup Serie F-100, F-150, Lobo	80-89 T	<b>32268</b>	(Pág. 78)	Toyota — Tacoma	95-04 TD
Ford — Pickup Serie F-350	80-98 T	Monroe® Monro-Matic Plus® Amortiguador		<b>32295</b>	(Pág. 132)
Ford — Pickup Serie F-450	99-04 T	Ford — Van Econoline	10-14 T	Monroe® Monro-Matic Plus® Amortiguador	
Ford — Pickup Serie F-550	99-04 T	Ford — Van Serie E	92-14 T	Toyota — Tacoma	95-04 TI
<b>32243</b>	(Pág. 76)	<b>32269</b>	(Pág. 93)	<b>32296</b>	(Pág. 67, 76)
Monroe® Monro-Matic Plus® Amortiguador		Monroe® Monro-Matic Plus® Amortiguador		Monroe® Monro-Matic Plus® Amortiguador	
Ford — Ranger	83-89 D	Jeep — Grand Cherokee	93-98 T	Ford — Explorer	95-06 D
<b>32245</b>	(Pág. 128)	<b>32270</b>	(Pág. 128)	Ford — Ranger	98-11 D
Monroe® Monro-Matic Plus® Amortiguador		Monroe® Monro-Matic Plus® Amortiguador		<b>32300</b>	(Pág. 32, 43, 79, 83)
Toyota — Pickup Compact	86-95 D	Toyota — Pickup T100	93-98 T	Monroe® Monro-Matic Plus® Amortiguador	
Toyota — Pickup T100	93-98 D	<b>32273</b>	(Pág. 105)	Chevrolet — Blazer	94-05 D
<b>32250</b>	(Pág. 56-57)	Monroe® Monro-Matic Plus® Amortiguador		Chevrolet — S-10	94-05 D
Monroe® Monro-Matic Plus® Amortiguador		Mitsubishi — Montero	92-00 D	GMC — Envoy	00-01 D
Dodge — Dakota	87-04 D	<b>32274</b>	(Pág. 105)	GMC — Sonoma 2WD	94-05 D
Dodge — Durango	98-03 D	Monroe® Monro-Matic Plus® Amortiguador		<b>32302</b>	(Pág. 66, 71-72)
		Mitsubishi — Montero	92-00 T	Monroe® Monro-Matic Plus® Amortiguador	
				Ford — Expedition	97-02 D
				Ford — Pickup Serie F-100, F-150, Lobo	97-04 D

Números de parte con P (P--) indican accesorios con la unidad



# PROGRESIVO AMORTIGADORES

## INDICE PROGRESIVO DE APLICACIONES

Vehículo	Años Pos.	Vehículo	Años Pos.	Vehículo	Años Pos.
<b>32302 (Cont.)</b>	(Pág. 66, 71-72)	<b>32328</b>	(Pág. 41, 80)	<b>32348</b>	(Pág. 43-46, 83)
Monroe® Monro-Matic Plus® Amortiguador		Monroe® Monro-Matic Plus® Amortiguador		Monroe® Monro-Matic Plus® Amortiguador	
Ford — Pickup Serie F-250	97-99 D	Chevrolet — Pickup Silverado	99-07 D	Chevrolet — Sonora	01-06 T
<b>32303</b>	(Pág. 71)	GMC — Pickup Sierra 1500	99-07 D	Chevrolet — Suburban	95-06 T
Monroe® Monro-Matic Plus® Amortiguador		<b>32329</b>	(Pág. 41, 80)	Chevrolet — Tahoe	01-06 T
Ford — Pickup Serie F-100, F-150,	97-03 T	Monroe® Monro-Matic Plus® Amortiguador		GMC — Yukon	01-06 T
Lobo		Chevrolet — Pickup Silverado	99-07 T	<b>32350</b>	(Pág. 32, 41-42, 44-45, 79-81)
<b>32304</b>	(Pág. 66, 72-73)	GMC — Pickup Sierra 1500	99-07 T	Monroe® Monro-Matic Plus® Amortiguador	
Monroe® Monro-Matic Plus® Amortiguador		<b>32330</b>	(Pág. 76)	Chevrolet — Avalanche	02-06 D
Ford — Expedition	97-02 D	Monroe® Monro-Matic Plus® Amortiguador		Chevrolet — Pickup Silverado	99-10 D
Ford — Pickup Serie F-100, F-150,	97-03 D	Ford — Ranger	98-11 D	Chevrolet — Suburban	00-13 D
Lobo		<b>32333</b>	(Pág. 47-48, 114-115)	GMC — Pickup Sierra 1500	05-07 D
Ford — Pickup Serie F-250	97-99 D	Monroe® Monro-Matic Plus® Amortiguador			01-03 D
<b>32306</b>	(Pág. 94)	Chevrolet — Uplander	05-09 T	GMC — Pickup Sierra 2500	99-10 D
Monroe® Monro-Matic Plus® Amortiguador		Chevrolet — Venture (Mini Van)	97-05 T	GMC — Pickup Sierra 3500	01-10 D
Jeep — Wrangler	96-06 T	AWD		<b>32356</b>	(Pág. 65, 72-73)
<b>32316</b>	(Pág. 46)	Oldsmobile — Silhouette	97-05 T	Monroe® Monro-Matic Plus® Amortiguador	
Monroe® Monro-Matic Plus® Amortiguador		Pontiac — Aztek AWD	01-05 T	Ford — Excursion	00-05 D
Chevrolet — Tracker	98-04 TD	<b>32334</b>	(Pág. 123)	Ford — Pickup Serie F-250	99-16 D
	98-04 TI	Monroe® Monro-Matic Plus® Amortiguador		Ford — Pickup Serie F-350	99-16 D
	89-92 T	Toyota — 4 Runner	96-02 T	<b>32357</b>	(Pág. 72-73)
<b>32318</b>	(Pág. 56-57)	<b>32338</b>	(Pág. 93)	Monroe® Monro-Matic Plus® Amortiguador	
Monroe® Monro-Matic Plus® Amortiguador		Monroe® Monro-Matic Plus® Amortiguador		Ford — Pickup Serie F-250	99-04 T
Dodge — Dakota	97-04 D	Jeep — Grand Cherokee	99-04 D	Ford — Pickup Serie F-350	99-04 T
Dodge — Durango	99-03 D	<b>32339</b>	(Pág. 93)	<b>32358</b>	(Pág. 73-75)
<b>32319</b>	(Pág. 56-57)	Monroe® Monro-Matic Plus® Amortiguador		Monroe® Monro-Matic Plus® Amortiguador	
Monroe® Monro-Matic Plus® Amortiguador		Jeep — Grand Cherokee	99-04 T	Ford — Pickup Serie F-250	99-04 D
Dodge — Dakota	97-04 T	<b>32340</b>	(Pág. 42, 44, 81)	Ford — Pickup Serie F-350	99-04 D
Dodge — Durango	99-03 T	Monroe® Monro-Matic Plus® Amortiguador		Ford — Pickup Serie F-450	99-04 D
<b>32321</b>	(Pág. 56-57)	Chevrolet — Pickup Silverado	99-04 D	Ford — Pickup Serie F-550	99-04 D
Monroe® Monro-Matic Plus® Amortiguador		Chevrolet — Suburban	00-01 D	<b>32359</b>	(Pág. 73-74)
Dodge — Dakota	97-04 T	GMC — Pickup Sierra 2500	99-04 D	Monroe® Monro-Matic Plus® Amortiguador	
Dodge — Durango	98-03 T	<b>32341</b>	(Pág. 41-42, 79-81)	Ford — Pickup Serie F-250	99-04 T
<b>32322</b>	(Pág. 66)	Monroe® Monro-Matic Plus® Amortiguador		Ford — Pickup Serie F-350	99-16 T
Monroe® Monro-Matic Plus® Amortiguador		Chevrolet — Pickup Silverado	05-07 T	<b>32361</b>	(Pág. 48)
Ford — Expedition	97-02 T		01-03 T	Monroe® Monro-Matic Plus® Amortiguador	
<b>32323</b>	(Pág. 66)		99-10 T	Chevrolet — Van 1500 Express,	93-96 D
Monroe® Monro-Matic Plus® Amortiguador		GMC — Pickup Sierra 1500	05-07 T	Savana, Modelos G y P	
Ford — Expedition	97-02 T		05-07 T	<b>32362</b>	(Pág. 39, 44, 47-48, 82)
<b>32324</b>	(Pág. 71-72)		01-03 T	Monroe® Monro-Matic Plus® Amortiguador	
Monroe® Monro-Matic Plus® Amortiguador		GMC — Pickup Sierra 2500	99-10 T	Chevrolet — Pickup C y R	87-00 D
Ford — Pickup Serie F-100, F-150,	00-04 T	<b>32345</b>	(Pág. 32, 42, 45, 81)	Chevrolet — Suburban	92-99 D
Lobo		Monroe® Monro-Matic Plus® Amortiguador		Chevrolet — Van 1500 Express,	96-18 D
Ford — Pickup Serie F-250	97-99 T	Chevrolet — Avalanche	02-06 T	Savana, Modelos G y P	
<b>32325</b>	(Pág. 73)	Chevrolet — Pickup Silverado	01-10 T	Chevrolet — Van Express Cargo	09-14 D
Monroe® Monro-Matic Plus® Amortiguador		Chevrolet — Suburban	00-13 T	GMC — Pickup Series C, R, K y V	87-00 D
Ford — Pickup Serie F-250	97-99 T	GMC — Pickup Sierra 3500	01-10 T	<b>32365</b>	(Pág. 59-60)
<b>32326</b>	(Pág. 41, 80)	<b>32346</b>	(Pág. 66-67)	Monroe® Monro-Matic Plus® Amortiguador	
Monroe® Monro-Matic Plus® Amortiguador		Monroe® Monro-Matic Plus® Amortiguador		Dodge — Pickup Ram 2500	94-02 T
Chevrolet — Pickup Silverado	99-07 D	Ford — Explorer	95-06 D	Dodge — Pickup Ram 3500	94-02 T
GMC — Pickup Sierra 1500	99-07 D	<b>32347</b>	(Pág. 43-46, 83)	<b>32366</b>	(Pág. 59-60)
<b>32327</b>	(Pág. 41, 80)	Monroe® Monro-Matic Plus® Amortiguador		Monroe® Monro-Matic Plus® Amortiguador	
Monroe® Monro-Matic Plus® Amortiguador		Chevrolet — Sonora	01-06 D	Dodge — Pickup Ram 2500	94-02 D
Chevrolet — Pickup Silverado	99-07 T	Chevrolet — Suburban	95-06 D	Dodge — Pickup Ram 3500	94-02 D
GMC — Pickup Sierra 1500	99-07 T	Chevrolet — Tahoe	01-06 D	<b>32370</b>	(Pág. 75)
		GMC — Yukon	01-06 D	Monroe® Monro-Matic Plus® Amortiguador	
				Ford — Pickup Serie F-450	93-98 D

Números de parte con P (P--) indican accesorios con la unidad



# PROGRESIVO AMORTIGUADORES

## INDICE PROGRESIVO DE APLICACIONES

Vehículo	Años Pos.	Vehículo	Años Pos.	Vehículo	Años Pos.
<b>32372</b>	(Pág. 72-73)	<b>32405</b>	(Pág. 53, 57)	<b>33095 (Cont.)</b>	(Pág. 50-51, 53, 57-58, 62, 114-115)
Monroe® Monro-Matic Plus® Amortiguador		Monroe® Monro-Matic Plus® Amortiguador		Monroe® Monro-Matic Plus® Amortiguador	
Ford — Pickup Serie F-250	92-96 T	Dodge — Aspen	06-09 D	Dodge — Spirit	89-95 T
Ford — Pickup Serie F-350	92-98 T	Dodge — Durango	04-09 D	Plymouth — Acclaim	89-95 T
<b>32373</b>	(Pág. 40, 82)	<b>32406</b>	(Pág. 53, 57)	Plymouth — Caravelle	84-88 T
Monroe® Monro-Matic Plus® Amortiguador		Monroe® Monro-Matic Plus® Amortiguador		Plymouth — Reliant	81-89 T
Chevrolet — Pickup K y V	87-00 D	Dodge — Aspen	06-09 T	Plymouth — Sundance	87-94 T
GMC — Pickup Series C, R, K y V	87-00 D	Dodge — Durango	04-09 T		
<b>32376</b>	(Pág. 61)	<b>32407</b>	(Pág. 92-93)	<b>33108</b>	(Pág. 29, 34, 113)
Monroe® Monro-Matic Plus® Amortiguador		Monroe® Monro-Matic Plus® Amortiguador		Monroe® Monro-Matic Plus® Amortiguador	
Dodge — Pickup D y W	72-93 D	Monroe® Monro-Matic Plus® Amortiguador		Buick — Century	85-96 T
<b>32381</b>	(Pág. 64)	Jeep — Commander	06-10 T	Chevrolet — Celebrity	82-90 T
Monroe® Monro-Matic Plus® Amortiguador		Jeep — Grand Cherokee	05-10 T	Chevrolet — Citation	82-84 T
Ford — Bronco	80-96 D			Oldsmobile — Cutlass Ciera	85-96 T
<b>32383</b>	(Pág. 128)	<b>32410</b>	(Pág. 106)	Oldsmobile — Eurosport	85-90 T
Monroe® Monro-Matic Plus® Amortiguador		Monroe® Monro-Matic Plus® Amortiguador		Oldsmobile — Omega	80-84 T
Toyota — Pickup Compact	85-93 D	Nissan — Altima	02-06 TD		
<b>32385</b>	(Pág. 61-62)		02-06 TI	<b>33127</b>	(Pág. 64, 70, 99)
Monroe® Monro-Matic Plus® Amortiguador		<b>33033</b>	(Pág. 39, 47, 53, 81-82)	Monroe® Monro-Matic Plus® Amortiguador	
Dodge — Pickup D y W	72-93 T	Monroe® Monro-Matic Plus® Amortiguador		Ford — Crown Victoria	93-02 D
Dodge — Ramcharger	74-93 T	Chevrolet — Pickup C y R	63-91 D	Ford — Grand Marquis	01-02 D
<b>32386</b>	(Pág. 74, 72)	Chevrolet — Van 1500 Express, Savana, Modelos G y P	63-89 D	Lincoln — Town Car	86-02 D
Monroe® Monro-Matic Plus® Amortiguador		Dina — 1000, 3000	78-90 D		
Ford — Pickup Serie F-100, F-150, Lobo	90-96 T	GMC — Pickup Series C, R, K y V	63-91 D	<b>33128</b>	(Pág. 64, 70, 99)
Ford — Pickup Serie F-350	08-16 T			Monroe® Monro-Matic Plus® Amortiguador	
	99-04 T	<b>33049</b>	(Pág. 69-70, 91, 106)	Ford — Crown Victoria	93-02 T
<b>32388</b>	(Pág. 105)	Monroe® Monro-Matic Plus® Amortiguador			83-91 T
Monroe® Monro-Matic Plus® Amortiguador		Ford — Galaxie	65-74 T	Ford — Grand Marquis	01-02 T
Mitsubishi — Montero	00-04 D	Ford — LTD	67-82 T	Lincoln — Town Car	86-02 T
<b>32389</b>	(Pág. 105)	Isuzu — Rodeo	91-95 T		
Monroe® Monro-Matic Plus® Amortiguador		Isuzu — Trooper	87-91 T	<b>33134</b>	(Pág. 77, 102)
Mitsubishi — Montero	00-04 T	Nissan — Datsun	74-77 T	Monroe® Monro-Matic Plus® Amortiguador	
<b>32390</b>	(Pág. 59)			Ford — Thunderbird	92-97 T
Monroe® Monro-Matic Plus® Amortiguador		<b>33059</b>	(Pág. 70-71)	Mercury — Cougar	92-97 T
Dodge — Pickup Ram 1500	02-08 D	Monroe® Monro-Matic Plus® Amortiguador			
<b>32391</b>	(Pág. 59)	Ford — Maverick	69-77 D	<b>33136</b>	(Pág. 64)
Monroe® Monro-Matic Plus® Amortiguador		Ford — Mustang	65-70 D	Monroe® Monro-Matic Plus® Amortiguador	
Dodge — Pickup Ram 1500	02-08 T			Ford — Crown Victoria	93-02 T
<b>32392</b>	(Pág. 59)	<b>33084</b>	(Pág. 39, 47, 53, 81-82)	<b>33137</b>	(Pág. 71)
Monroe® Monro-Matic Plus® Amortiguador		Monroe® Monro-Matic Plus® Amortiguador		Monroe® Monro-Matic Plus® Amortiguador	
Dodge — Pickup Ram 1500	02-05 D	Chevrolet — Pickup K y V	81-87 T	Ford — Mustang	94-04 T
<b>32399</b>	(Pág. 87)	Chevrolet — Pickup C y R	73-89 T		
Monroe® Monro-Matic Plus® Amortiguador		Chevrolet — Van 1500 Express, Savana, Modelos G y P	73-89 T	<b>33146</b>	(Pág. 64)
Dodge — Pickup Ram 1500	02-05 D	Dina — 1000, 3000	78-86 T	Monroe® Monro-Matic Plus® Amortiguador	
<b>32403</b>	(Pág. 133, 135-136)	GMC — Pickup Series C, R, K y V	73-87 T	Ford — Courier Pickup	00-12 T
Monroe® Monro-Matic Plus® Amortiguador				<b>33154</b>	(Pág. 49)
Volkswagen — Beetle	98-11 T	<b>33086</b>	(Pág. 39, 47, 63, 82)	Monroe® Monro-Matic Plus® Amortiguador	
Volkswagen — Golf A4	99-07 T	Monroe® Monro-Matic Plus® Amortiguador		Chevrolet — Zafira	00-07 TD
Volkswagen — Jetta A4	99-10 T	Chevrolet — Pickup K y V	81-87 D		00-07 TI
Volkswagen — Jetta Clasico	11-15 T	Chevrolet — Van 1500 Express, Savana, Modelos G y P	78-95 T	<b>33157</b>	(Pág. 64)
<b>32404</b>	(Pág. 69)	Dodge — Van Ram	70-03 T	Monroe® Monro-Matic Plus® Amortiguador	
Monroe® Monro-Matic Plus® Amortiguador		GMC — Pickup Series C, R, K y V	81-87 D	Ford — EcoSport	04-12 T
Ford — Focus	00-11 TD			<b>33158</b>	(Pág. 67)
	00-11 TI	<b>33095</b>	(Pág. 50-51, 53, 57-58, 62, 114-115)	Monroe® Monro-Matic Plus® Amortiguador	
		Monroe® Monro-Matic Plus® Amortiguador		Ford — Fiesta	03-10 T
		Chrysler — LeBaron	89-95 T		
		Chrysler — New Yorker y Fifth Avenue	84-87 T	<b>33159</b>	(Pág. 38, 46)
		Dodge — 600	83-88 T	Monroe® Monro-Matic Plus® Amortiguador	
		Dodge — Aries	83-89 T	Chevrolet — Meriva	03-08 TD
		Dodge — Daytona	84-93 T		03-08 TI
		Dodge — Lancer	85-89 T	Chevrolet — Tornado	04-10 TD
		Dodge — Shadow	89-94 T		04-10 TI
				<b>33160</b>	(Pág. 134)
				Monroe® Monro-Matic Plus® Amortiguador	
				Volkswagen — Crossfox	05-17 T

Números de parte con P (P--) indican accesorios con la unidad



# PROGRESIVO AMORTIGADORES

## INDICE PROGRESIVO DE APLICACIONES

Vehículo	Años Pos.	Vehículo	Años Pos.	Vehículo	Años Pos.
<b>33178</b> Monroe® Monro-Matic Plus® Amortiguador Chevrolet — Colorado Pickup GMC — Canyon Pickup	(Pág. 35, 79) 04-12 D 04-12 D	<b>33203</b> Monroe® Monro-Matic Plus® Amortiguador Nissan — Tiida	(Pág. 111) 07-18 TD 07-18 TI	<b>33221 (Cont.)</b> Monroe® Monro-Matic Plus® Amortiguador Dodge — Challenger Dodge — Charger	(Pág. 49, 55-56) 09-10 T 06-10 T
<b>33179</b> Monroe® Monro-Matic Plus® Amortiguador Chevrolet — Colorado Pickup GMC — Canyon Pickup	(Pág. 35, 79) 04-12 T 04-12 T	<b>33204</b> Monroe® Monro-Matic Plus® Amortiguador Nissan — Murano	(Pág. 108) 09-13 TD 09-13 TI	<b>33222</b> Monroe® Monro-Matic Plus® Amortiguador Nissan — Xterra	(Pág. 112) 05-15 T
<b>33180</b> Monroe® Monro-Matic Plus® Amortiguador Nissan — Xterra	(Pág. 112) 00-01 D	<b>33205</b> Monroe® Monro-Matic Plus® Amortiguador Nissan — Sentra	(Pág. 110) 07-12 TD 07-12 TI	<b>33224</b> Monroe® Monro-Matic Plus® Amortiguador Nissan — Maxima	(Pág. 108) 04-08 TD 04-08 TI
<b>33181</b> Monroe® Monro-Matic Plus® Amortiguador Nissan — Xterra	(Pág. 112) 00-04 T	<b>33206</b> Monroe® Monro-Matic Plus® Amortiguador Ford — Edge	(Pág. 64, 98) 11-14 TD 11-14 TI	<b>33225</b> Monroe® Monro-Matic Plus® Amortiguador Nissan — Titan Pickup	(Pág. 111) 04-15 T
<b>33182</b> Monroe® Monro-Matic Plus® Amortiguador Nissan — Frontier Pickup Nissan — Xterra	(Pág. 107, 112) 03-04 D 02-04 D	<b>33207</b> Monroe® Monro-Matic Plus® Amortiguador Saturn — Ion	(Pág. 119) 03-06 T	<b>33274</b> Monroe® Monro-Matic Plus® Amortiguador Honda — Odyssey (Mini Van)	(Pág. 87) 99-04 TD 99-04 TI
<b>33185</b> Monroe® Monro-Matic Plus® Amortiguador Honda — Civic	(Pág. 85) 06-11 TD 06-11 TI	<b>33208</b> Monroe® Monro-Matic Plus® Amortiguador Toyota — Tundra	(Pág. 133) 00-06 T	<b>33275</b> Monroe® Monro-Matic Plus® Amortiguador Toyota — Sienna	(Pág. 131) 98-03 TD 98-03 TI
<b>33187</b> Monroe® Monro-Matic Plus® Amortiguador Ford — Escape	(Pág. 65) 01-07 TD 01-07 TI	<b>33209</b> Monroe® Monro-Matic Plus® Amortiguador Dodge — Attitude	(Pág. 99) 06-11 TD 06-11 TI	<b>34501</b> Monroe® Gas-Magnum® Amortiguador Chevrolet — Sonora Chevrolet — Suburban Chevrolet — Tahoe GMC — Yukon	(Pág. 43-46, 83) 01-06 D 00-06 D 01-06 D 01-06 D
<b>33192</b> Monroe® Monro-Matic Plus® Amortiguador Honda — Pilot	(Pág. 87) 06-08 TD 06-08 TI 03-05 T	<b>33210</b> Monroe® Monro-Matic Plus® Amortiguador Mazda — 3	(Pág. 99) 12-13 TD 12-13 TI	<b>34504</b> Monroe® Gas-Magnum® Amortiguador Chevrolet — Avalanche Chevrolet — Pickup Silverado Chevrolet — Suburban GMC — Pickup Sierra 1500	(Pág. 32, 41-42, 44-45, 79-81) 02-06 D 99-10 D 00-13 D 05-07 D 01-03 D 99-10 D 01-10 D
<b>33193</b> Monroe® Monro-Matic Plus® Amortiguador Buick — Enclave Chevrolet — Traverse	(Pág. 29, 47) 08-17 T 09-17 T	<b>33211</b> Monroe® Monro-Matic Plus® Amortiguador Toyota — Sequoia	(Pág. 130) 01-07 T	<b>34514</b> Monroe® Gas-Magnum® Amortiguador Dodge — Pickup Ram 1500	(Pág. 59) 02-08 D
<b>33194</b> Monroe® Monro-Matic Plus® Amortiguador Honda — Odyssey (Mini Van)	(Pág. 87) 05-07 TD 05-07 TI	<b>33212</b> Monroe® Monro-Matic Plus® Amortiguador Toyota — Tundra	(Pág. 132) 00-06 T	<b>34515</b> Monroe® Gas-Magnum® Amortiguador Dodge — Pickup Ram 1500	(Pág. 59) 02-08 T
<b>33195</b> Monroe® Monro-Matic Plus® Amortiguador Chevrolet — Malibu	(Pág. 38) 04-07 TD 04-07 TI	<b>33213</b> Monroe® OESpectrum® Nissan — Pathfinder	(Pág. 109) 02-03 T 98-01 TD 98-01 TI	<b>34516</b> Monroe® Gas-Magnum® Amortiguador Dodge — Pickup Ram 1500	(Pág. 59) 02-05 D
<b>33196</b> Monroe® Monro-Matic Plus® Amortiguador Nissan — Altima	(Pág. 105-106) 07-18 TD 07-18 TI	<b>33214</b> Monroe® OESpectrum® Dodge — Dart	(Pág. 56-57) 13-16 TD 13-16 TI	<b>34517</b> Monroe® Gas-Magnum® Amortiguador Ford — Excursion	(Pág. 65) 00-05 T
<b>33200</b> Monroe® Monro-Matic Plus® Amortiguador Ford — Escape Mercury — Mariner	(Pág. 65, 102) 08-12 TD 08-12 TI 08-11 TD 08-11 TI	<b>33215</b> Monroe® Monro-Matic Plus® Amortiguador Nissan — Titan Pickup	(Pág. 111) 04-15 T	<b>34518</b> Monroe® Gas-Magnum® Amortiguador Ford — Excursion	(Pág. 65) 00-05 D
<b>33202</b> Monroe® Monro-Matic Plus® Amortiguador Ford — Edge	(Pág. 65) 07-10 TD 07-10 TI	<b>33216</b> Monroe® OESpectrum® Toyota — Prius	(Pág. 129) 10-15 TD 10-15 TI	<b>34519</b> Monroe® Gas-Magnum® Amortiguador Ford — Excursion	(Pág. 65) 00-05 T
		<b>33221</b> Monroe® Monro-Matic Plus® Amortiguador Chrysler — 300, 300C y 300M	(Pág. 49, 55-56) 05-10 T		

Números de parte con P (P--) indican accesorios con la unidad



# PROGRESIVO AMORTIGUADORES

## INDICE PROGRESIVO DE APLICACIONES

Vehículo	Años Pos.	Vehículo	Años Pos.	Vehículo	Años Pos.
<b>34520</b>	(Pág. 59-60, 117)	<b>34656</b>	(Pág. 71)	<b>34687</b>	(Pág. 73-74)
Monroe® Gas-Magnum® Amortiguador		Monroe® Gas-Magnum® Amortiguador		Monroe® Gas-Magnum® Amortiguador	
Dodge — Pickup Ram 1500	06-08 D	Ford — Pickup Serie F-100, F-150,	97-03 T	Ford — Pickup Serie F-250	99-04 T
Dodge — Pickup Ram 2500	03-10 D	Lobo		Ford — Pickup Serie F-350	99-16 T
Dodge — Pickup Ram 3500	03-10 D	<b>34657</b>	(Pág. 66, 72-73)	<b>34689</b>	(Pág. 42, 44, 81)
RAM — Serie 2500	10-13 D	Monroe® Gas-Magnum® Amortiguador		Monroe® Gas-Magnum® Amortiguador	
<b>34521</b>	(Pág. 59-60, 117)	Ford — Expedition	97-02 D	Chevrolet — Pickup Silverado	99-04 D
Monroe® Gas-Magnum® Amortiguador		Ford — Pickup Serie F-100, F-150,	97-03 D	Chevrolet — Suburban	00-01 D
Dodge — Pickup Ram 1500	06-08 T	Lobo		GMC — Pickup Sierra 2500	99-04 D
Dodge — Pickup Ram 2500	03-13 T	Ford — Pickup Serie F-250	97-99 D	<b>34690</b>	(Pág. 41-42, 80-81)
Dodge — Pickup Ram 3500	03-12 T	<b>34658</b>	(Pág. 72)	Monroe® Gas-Magnum® Amortiguador	
RAM — Serie 2500	10-13 T	Monroe® Gas-Magnum® Amortiguador		Chevrolet — Pickup Silverado	99-10 T
<b>34522</b>	(Pág. 59-60)	Ford — Pickup Serie F-100, F-150,	97-03 T	GMC — Pickup Sierra 1500	05-07 T
Monroe® Gas-Magnum® Amortiguador		Lobo		01-03 T	
Dodge — Pickup Ram 2500	03-13 D	<b>34672</b>	(Pág. 66)	GMC — Pickup Sierra 2500	99-10 T
Dodge — Pickup Ram 3500	03-13 D	Monroe® Gas-Magnum® Amortiguador		<b>34692</b>	(Pág. 43-46, 83)
<b>34523</b>	(Pág. 75)	Ford — Expedition	97-02 T	Monroe® Gas-Magnum® Amortiguador	
Monroe® Gas-Magnum® Amortiguador		<b>34673</b>	(Pág. 71-72)	Chevrolet — Sonora	01-06 T
Ford — Pickup Serie F-450	17-19 D	Monroe® Gas-Magnum® Amortiguador		Chevrolet — Suburban	00-06 T
05-15 D		Ford — Pickup Serie F-100, F-150,	00-04 T	Chevrolet — Tahoe	01-06 T
Ford — Pickup Serie F-550	05-06 D	Lobo		GMC — Yukon	01-06 T
<b>34524</b>	(Pág. 75)	Ford — Pickup Serie F-250	97-99 T	<b>34694</b>	(Pág. 42, 45, 81)
Monroe® Gas-Magnum® Amortiguador		<b>34674</b>	(Pág. 73)	Monroe® Gas-Magnum® Amortiguador	
Ford — Pickup Serie F-450	05-15 T	Monroe® Gas-Magnum® Amortiguador		Chevrolet — Pickup Silverado	01-10 T
Ford — Pickup Serie F-550	05-06 T	Ford — Pickup Serie F-250	97-99 T	Chevrolet — Suburban	00-13 T
<b>34525</b>	(Pág. 73-74)	<b>34675</b>	(Pág. 41, 80)	GMC — Pickup Sierra 3500	01-10 T
Monroe® Gas-Magnum® Amortiguador		Monroe® Gas-Magnum® Amortiguador		<b>34729</b>	(Pág. 63-64, 71-74)
Ford — Pickup Serie F-250	05-19 D	Chevrolet — Pickup Silverado	99-07 D	Monroe® Gas-Magnum® Amortiguador	
Ford — Pickup Serie F-350	05-19 D	GMC — Pickup Sierra 1500	99-07 D	Ford — Bronco	80-96 D
<b>34526</b>	(Pág. 73-74)	<b>34676</b>	(Pág. 41, 80)	Ford — Pickup Serie F-100, F-150,	80-96 D
Monroe® Gas-Magnum® Amortiguador		Monroe® Gas-Magnum® Amortiguador		Lobo	
Ford — Pickup Serie F-250	05-16 T	Chevrolet — Pickup Silverado	99-07 T	Ford — Pickup Serie F-250	80-86 D
Ford — Pickup Serie F-350	05-07 T	GMC — Pickup Sierra 1500	99-07 T	Ford — Pickup Serie F-350	80-86 D
<b>34529</b>	(Pág. 60)	<b>34677</b>	(Pág. 41, 80)	<b>34730</b>	(Pág. 72, 73)
Monroe® Gas-Magnum® Amortiguador		Monroe® Gas-Magnum® Amortiguador		Monroe® Gas-Magnum® Amortiguador	
Dodge — Pickup Ram 3500	07-13 T	Chevrolet — Pickup Silverado	99-07 D	Ford — Pickup Serie F-250	87-91 D
<b>34530</b>	(Pág. 47-48, 83)	GMC — Pickup Sierra 1500	99-07 D	Ford — Pickup Serie F-350	87-91 D
Monroe® Gas-Magnum® Amortiguador		<b>34678</b>	(Pág. 41, 80)	<b>34731</b>	(Pág. 73-74)
Chevrolet — Van 1500 Express,	03-18 D	Monroe® Gas-Magnum® Amortiguador		Monroe® Gas-Magnum® Amortiguador	
Savana, Modelos G y P		Chevrolet — Pickup Silverado	99-07 T	Ford — Pickup Serie F-350	80-98 T
GMC — Savana	09-16 D	GMC — Pickup Sierra 1500	99-07 T	<b>34732</b>	(Pág. 73-74, 137)
<b>34531</b>	(Pág. 48)	<b>34684</b>	(Pág. 65, 72-73)	Monroe® Gas-Magnum® Amortiguador	
Monroe® Gas-Magnum® Amortiguador		Monroe® Gas-Magnum® Amortiguador		Ford — Pickup Serie F-250	87-96 D
Chevrolet — Van Express Cargo	09-14 T	Ford — Excursion	00-05 D	Ford — Pickup Serie F-350	85-98 D
<b>34532</b>	(Pág. 48, 83)	Ford — Pickup Serie F-250	99-16 D	Volkswagen — Van Caravelle	72-95 T
Monroe® Gas-Magnum® Amortiguador		Ford — Pickup Serie F-350	99-16 D	Volkswagen — Van Combi	72-01 T
Chevrolet — Van 1500 Express,	09-15 T	<b>34685</b>	(Pág. 72-73)	Volkswagen — Van Panel	72-95 T
Savana, Modelos G y P		Monroe® Gas-Magnum® Amortiguador		<b>34733</b>	(Pág. 75)
GMC — Savana	09-16 T	Ford — Pickup Serie F-250	99-04 T	Monroe® Gas-Magnum® Amortiguador	
<b>34534</b>	(Pág. 59)	Ford — Pickup Serie F-350	99-04 T	Ford — Pickup Serie F-450	88-93 D
Monroe® Gas-Magnum® Amortiguador		<b>34686</b>	(Pág. 73-75)	<b>34736</b>	(Pág. 48, 53)
Dodge — Pickup Ram 2500	14-16 D	Monroe® Gas-Magnum® Amortiguador		Monroe® Gas-Magnum® Amortiguador	
<b>34655</b>	(Pág. 66, 71-72)	Ford — Pickup Serie F-250	99-04 D	Chevrolet — Van 1500 Express,	93-96 D
Monroe® Gas-Magnum® Amortiguador		Ford — Pickup Serie F-350	99-04 D	Savana, Modelos G y P	
Ford — Expedition	97-02 D	Ford — Pickup Serie F-450	99-04 D	Dina — 1000, 3000	85-90 D
Ford — Pickup Serie F-100, F-150,	97-04 D	Ford — Pickup Serie F-550	99-04 D	<b>34740</b>	(Pág. 83)
Lobo				Monroe® Magnum™ Amortiguador	
Ford — Pickup Serie F-250	97-99 D			GMC — Sonoma 2WD	83-93 D

Números de parte con P (P--) indican accesorios con la unidad





# PROGRESIVO AMORTIGUADORES

## INDICE PROGRESIVO DE APLICACIONES

Vehículo	Años Pos.	Vehículo	Años Pos.	Vehículo	Años Pos.
<b>34741</b>	(Pág. 39, 44, 47-48, 82)	<b>34770</b>	(Pág. 72-73)	<b>34793 (Cont.)</b>	(Pág. 50, 72-73)
Monroe® Gas-Magnum® Amortiguador		Monroe® Gas-Magnum® Amortiguador		Monroe® Gas-Magnum® Amortiguador	
Chevrolet — Pickup C y R	87-00 D	Ford — Pickup Serie F-250	05-16 T	Ford — Pickup Serie F-250	92-96 D
Chevrolet — Suburban	92-99 D	Ford — Pickup Serie F-350	05-16 T	Ford — Pickup Serie F-350	92-98 D
Chevrolet — Van 1500 Express, Savana, Modelos G y P	96-02 D	<b>34771</b>	(Pág. 61)	<b>34794</b>	(Pág. 63)
GMC — Pickup Series C, R, K y V	87-00 D	Monroe® Gas-Magnum® Amortiguador		Monroe® Gas-Magnum® Amortiguador	
<b>34750</b>	(Pág. 61-62)	Dodge — Pickup D y W	92-93 T	Dodge — Van Ram	94-03 D
Monroe® Gas-Magnum® Amortiguador		<b>34776</b>	(Pág. 59-60)	<b>34795</b>	(Pág. 58-59, 117)
Dodge — Pickup D y W	72-93 D	Monroe® Gas-Magnum® Amortiguador		Monroe® Gas-Magnum® Amortiguador	
Dodge — Ramcharger	75-93 D	Dodge — Pickup Ram 1500	94-01 D	Dodge — Pickup Ram 1500	09-18 T
<b>34754</b>	(Pág. 112)	Dodge — Pickup Ram 2500	94-02 D	RAM — Serie 1500	11-18 T
Monroe® Magnum™ Amortiguador		Dodge — Pickup Ram 3500	94-02 D	<b>34796</b>	(Pág. 78)
Nissan — Van Ichi Van	87-94 D	<b>34777</b>	(Pág. 59-60)	Monroe® Gas-Magnum® Amortiguador	
Nissan — Van Vanette Panel	87-94 D	Monroe® Gas-Magnum® Amortiguador		Ford — Van Econoline	10-14 D
<b>34755</b>	(Pág. 42, 81)	Dodge — Pickup Ram 1500	94-01 T	Ford — Van Serie E	92-07 D
Monroe® Gas-Magnum® Amortiguador		Dodge — Pickup Ram 2500	94-02 T	<b>34797</b>	(Pág. 72-73)
Chevrolet — Pickup Silverado	91-03 D	Dodge — Pickup Ram 3500	94-02 T	Monroe® Gas-Magnum® Amortiguador	
GMC — Pickup Sierra 3500	91-03 D	<b>34778</b>	(Pág. 59)	Ford — Pickup Serie F-250	92-96 T
<b>34756</b>	(Pág. 42, 48, 81)	Monroe® Gas-Magnum® Amortiguador		Ford — Pickup Serie F-350	92-98 T
Monroe® Gas-Magnum® Amortiguador		Dodge — Pickup Ram 1500	94-01 D	<b>34798</b>	(Pág. 31, 39, 45, 82-83)
Chevrolet — Pickup Silverado	91-03 T	Dodge — Pickup Ram 2500	94-02 D	Monroe® Gas-Magnum® Amortiguador	
Chevrolet — Van 1500 Express, Savana, Modelos G y P	96-02 T	<b>34781</b>	(Pág. 59-60)	Cadillac — Escalade	99-00 D
GMC — Pickup Sierra 3500	91-03 T	Monroe® Gas-Magnum® Amortiguador		Chevrolet — Pickup K y V	87-00 D
<b>34759</b>	(Pág. 78)	Dodge — Pickup Ram 2500	94-02 T	Chevrolet — Suburban	92-99 D
Monroe® Gas-Magnum® Amortiguador		Dodge — Pickup Ram 3500	94-02 T	GMC — Pickup Series C, R, K y V	87-00 D
Ford — Van Econoline	10-14 T	<b>34782</b>	(Pág. 59-60)	GMC — Yukon	95-99 D
Ford — Van Serie E	92-07 T	Monroe® Gas-Magnum® Amortiguador		<b>34799</b>	(Pág. 40, 82)
<b>34760</b>	(Pág. 78)	Dodge — Pickup Ram 2500	94-02 D	Monroe® Gas-Magnum® Amortiguador	
Monroe® Gas-Magnum® Amortiguador		Dodge — Pickup Ram 3500	94-02 D	Chevrolet — Pickup K y V	87-00 D
Ford — Van Econoline	10-14 D	<b>34785</b>	(Pág. 56-57)	GMC — Pickup Series C, R, K y V	87-00 D
Ford — Van Serie E	92-14 D	Monroe® Gas-Magnum® Amortiguador		<b>34800</b>	(Pág. 58, 117)
<b>34761</b>	(Pág. 78)	Dodge — Dakota	97-04 D	Monroe® Gas-Magnum® Amortiguador	
Monroe® Gas-Magnum® Amortiguador		Dodge — Durango	99-03 D	Dodge — Pickup Ram 1500	09-10 D
Ford — Van Econoline	10-14 T	<b>34786</b>	(Pág. 56-57)	RAM — Serie 1500	11-18 D
Ford — Van Serie E	92-14 T	Monroe® Gas-Magnum® Amortiguador		<b>34803</b>	(Pág. 39, 47, 50, 53, 82, 92, 109, 128)
<b>34762</b>	(Pág. 44, 47-48)	Dodge — Dakota	97-04 T	Monroe® Gas-Magnum® Amortiguador	
Monroe® Gas-Magnum® Amortiguador		Dodge — Durango	99-03 T	Chevrolet — Pickup C y R	63-72 T
Chevrolet — Suburban	92-99 T	<b>34787</b>	(Pág. 127)	Chevrolet — Van 1500 Express, Savana, Modelos G y P	68-72 T
Chevrolet — Van 1500 Express, Savana, Modelos G y P	96-14 T	Monroe® Gas-Magnum® Amortiguador		Chevrolet — Suburban	63-66 T
Chevrolet — Van Cargo Van	97-00 T	Toyota — Land Cruiser	90-98 D	Chrysler — H-100	02-12 T
<b>34763</b>	(Pág. 31, 45, 47-48, 83)	<b>34788</b>	(Pág. 127)	Dina — 1000, 3000	85-90 T
Monroe® Gas-Magnum® Amortiguador		Monroe® Gas-Magnum® Amortiguador		GMC — Pickup Series C, R, K y V	63-72 T
Cadillac — Escalade	99-00 T	Toyota — Land Cruiser	90-98 T	Jeep — CJ	82-86 T
Chevrolet — Suburban	92-99 T	<b>34789</b>	(Pág. 56-57)	Nissan — Pickup	98-09 T
Chevrolet — Van 1500 Express, Savana, Modelos G y P	96-18 T	Monroe® Gas-Magnum® Amortiguador		Nissan — Pickup D-21	65-94 T
GMC — Yukon	95-99 T	Dodge — Dakota	97-04 T	Toyota — Pickup Compact	85-93 T
<b>34766</b>	(Pág. 93)	Dodge — Durango	98-03 T	<b>34804</b>	(Pág. 67, 76)
Monroe® Gas-Magnum® Amortiguador		<b>34790</b>	(Pág. 56-57)	Monroe® Gas-Magnum® Amortiguador	
Jeep — Grand Cherokee	99-04 D	Monroe® Gas-Magnum® Amortiguador		Ford — Explorer	95-06 D
<b>34769</b>	(Pág. 93)	Dodge — Dakota	87-04 D	Ford — Ranger	98-11 D
Monroe® Gas-Magnum® Amortiguador		Dodge — Durango	98-03 D	<b>34810</b>	(Pág. 42, 81)
Monroe® Gas-Magnum® Amortiguador		<b>34791</b>	(Pág. 75)	Monroe® Gas-Magnum® Amortiguador	
Jeep — Grand Cherokee	99-04 T	Monroe® Gas-Magnum® Amortiguador		Chevrolet — Pickup Silverado	11-18 D
<b>34770</b>	(Pág. 72-73)	Ford — Pickup Serie F-450	93-98 D	<b>34811</b>	(Pág. 42, 81)
Monroe® Gas-Magnum® Amortiguador		<b>34793</b>	(Pág. 50, 72-73)	Monroe® Gas-Magnum® Amortiguador	
Ford — Pickup Serie F-250	05-16 T	Monroe® Gas-Magnum® Amortiguador		Chevrolet — Pickup Silverado	11-18 T
Ford — Pickup Serie F-350	05-16 T	Chrysler — H-100	02-12 D		

Números de parte con P (P--) indican accesorios con la unidad



# PROGRESIVO AMORTIGUADORES

## INDICE PROGRESIVO DE APLICACIONES

Vehículo	Años Pos.	Vehículo	Años Pos.	Vehículo	Años Pos.
<b>34812</b>	(Pág. 42, 81)	<b>34899</b>	(Pág. 78)	<b>34930</b>	(Pág. 72-75)
Monroe® Gas-Magnum® Amortiguador		Monroe® Gas-Magnum® Amortiguador		Monroe® Gas-Magnum® Amortiguador	
Chevrolet — Pickup Silverado	11-18 T	Ford — Van Serie E	75-91 D	Ford — Pickup Serie F-100, F-150, 80-89 T	
<b>34813</b>	(Pág. 60)	<b>34900</b>	(Pág. 71, 74, 78)	Lobo	
Monroe® Gas-Magnum® Amortiguador		Monroe® Gas-Magnum® Amortiguador		Ford — Pickup Serie F-250	80-91 T
Dodge — Pickup Ram 3500	11-13 D	Ford — Pickup Serie F-100, F-150,	70-79 D	Ford — Pickup Serie F-350	80-98 T
<b>34817</b>	(Pág. 39, 44, 47, 81-82)	Lobo		Ford — Pickup Serie F-450	99-04 T
Monroe® Gas-Magnum® Amortiguador		Ford — Pickup Serie F-350	67-79 D	Ford — Pickup Serie F-550	99-04 T
Chevrolet — Pickup C y R	63-91 D	Ford — Van Serie E	75-91 D	<b>34934</b>	(Pág. 37, 79, 83)
Chevrolet — Suburban	73-91 D	<b>34901</b>	(Pág. 78)	Monroe® Gas-Magnum® Amortiguador	
Chevrolet — Van 1500 Express,	63-89 D	Monroe® Gas-Magnum® Amortiguador		Chevrolet — LLV	87-95 T
Savana, Modelos G y P		Ford — Van Serie E	75-91 T	GMC — LLV	87-95 T
GMC — Pickup Series C, R, K y V	63-91 D	<b>34904</b>	(Pág. 112)	GMC — Sonoma 2WD	82-93 T
<b>34822</b>	(Pág. 33, 40, 45, 82)	Monroe® Gas-Magnum® Amortiguador		<b>34944</b>	(Pág. 33, 39-40, 45, 47, 82)
Monroe® Gas-Magnum® Amortiguador		Nissan — Van Ichi Van	87-94 T	Monroe® Gas-Magnum® Amortiguador	
Chevrolet — Blazer	69-72 T	Nissan — Van Vanette Panel	87-94 T	Chevrolet — Blazer	69-90 D
Chevrolet — Pickup K y V	69-72 T	<b>34910</b>	(Pág. 39-40, 47, 53, 63, 82)	Chevrolet — Pickup K y V	69-87 D
Chevrolet — Suburban	69-72 T	Monroe® Gas-Magnum® Amortiguador		Chevrolet — Suburban	69-91 D
GMC — Pickup Series C, R, K y V	69-72 T	Chevrolet — Pickup K y V	81-87 D	Chevrolet — Van 1500 Express,	67-72 T
<b>34824</b>	(Pág. 33, 39-40, 44-45, 47, 81-82)	Chevrolet — Van 1500 Express,	78-95 T	Savana, Modelos G y P	
Monroe® Gas-Magnum® Amortiguador		Savana, Modelos G y P		GMC — Pickup Series C, R, K y V	69-87 D
Chevrolet — Blazer	73-90 T	Chrysler — Voyager y Grand	74-83 T	<b>34945</b>	(Pág. 37, 79, 83)
Chevrolet — Pickup K y V	73-87 T	Voyager		Monroe® Gas-Magnum® Amortiguador	
Chevrolet — Pickup C y R	73-89 T	Dodge — Van Ram	70-03 T	Chevrolet — LLV	87-95 D
Chevrolet — Suburban	73-91 T	GMC — Pickup Series C, R, K y V	81-87 D	GMC — LLV	87-95 D
Chevrolet — Van 1500 Express,	73-89 T	<b>34911</b>	(Pág. 71, 74, 78)	GMC — Sonoma 2WD	82-93 D
Savana, Modelos G y P		Monroe® Gas-Magnum® Amortiguador		<b>34953</b>	(Pág. 128)
GMC — Pickup Series C, R, K y V	73-89 T	Ford — Pickup Serie F-100, F-150,	70-79 T	Monroe® Gas-Magnum® Amortiguador	
<b>34828</b>	(Pág. 127)	Lobo		Toyota — Pickup Compact	85-93 D
Monroe® Gas-Magnum® Amortiguador		Ford — Pickup Serie F-350	74-79 T	<b>34958</b>	(Pág. 92-93, 74)
Toyota — Land Cruiser	88-90 T	Ford — Van Serie E	75-91 T	Monroe® Gas-Magnum® Amortiguador	
<b>34831</b>	(Pág. 53, 63)	<b>34912</b>	(Pág. 48)	Ford — Pickup Serie F-350	67-79 T
Monroe® Gas-Magnum® Amortiguador		Monroe® Gas-Magnum® Amortiguador		Jeep — CJ	82-86 D
Chrysler — Voyager y Grand	74-83 D	Chevrolet — Van 1500 Express,	86-99 D	Jeep — Wagoneer (Grand	76-91 D
Voyager		Savana, Modelos G y P		Wagoneer)	76-91 T
Dodge — Van Ram	70-03 D	<b>34919</b>	(Pág. 40, 82)	<b>34959</b>	(Pág. 127)
<b>34832</b>	(Pág. 61-62)	Monroe® Gas-Magnum® Amortiguador		Monroe® Gas-Magnum® Amortiguador	
Monroe® Gas-Magnum® Amortiguador		Chevrolet — Pickup K y V	77-91 D	Toyota — Land Cruiser	88-90 D
Dodge — Pickup D y W	72-93 T	GMC — Pickup Series C, R, K y V	77-91 D	<b>34960</b>	(Pág. 39, 41, 48, 79, 82)
Dodge — Ramcharger	74-93 T	<b>34920</b>	(Pág. 40, 82)	Monroe® Gas-Magnum® Amortiguador	
<b>34839</b>	(Pág. 47-48)	Monroe® Gas-Magnum® Amortiguador		Chevrolet — Pickup C y R	73-91 T
Monroe® Gas-Magnum® Amortiguador		Chevrolet — Pickup K y V	77-91 T	Chevrolet — Pickup Silverado	05-07 T
Chevrolet — Van 1500 Express,	78-95 D	GMC — Pickup Series C, R, K y V	77-91 T	Chevrolet — Van 1500 Express,	86-99 T
Savana, Modelos G y P		<b>34926</b>	(Pág. 64)	Savana, Modelos G y P	
<b>34853</b>	(Pág. 61-62)	Monroe® Gas-Magnum® Amortiguador		GMC — Pickup Series C, R, K y V	73-91 T
Monroe® Gas-Magnum® Amortiguador		Ford — Bronco	80-96 D	GMC — Pickup Sierra 1500	05-07 T
Dodge — Pickup D y W	72-93 D	<b>34927</b>	(Pág. 63-64, 71, 75)	<b>34963</b>	(Pág. 71-74)
Dodge — Ramcharger	74-93 D	Monroe® Gas-Magnum® Amortiguador		Monroe® Gas-Magnum® Amortiguador	
<b>34854</b>	(Pág. 61-62)	Ford — Bronco	80-96 T	Ford — Pickup Serie F-100, F-150,	85-96 T
Monroe® Gas-Magnum® Amortiguador		Ford — Pickup Serie F-100, F-150,	80-84 T	Lobo	
Dodge — Pickup D y W	72-93 T	Lobo		Ford — Pickup Serie F-250	80-96 T
Dodge — Ramcharger	76-93 T	Ford — Pickup Serie F-450	88-98 T	Ford — Pickup Serie F-350	99-16 T
<b>34868</b>	(Pág. 53, 61, 63)	<b>34928</b>	(Pág. 72-74)	<b>34964</b>	(Pág. 72-74)
Monroe® Gas-Magnum® Amortiguador		Monroe® Gas-Magnum® Amortiguador		Monroe® Gas-Magnum® Amortiguador	
Chrysler — Voyager y Grand	74-83 D	Ford — Pickup Serie F-100, F-150,	80-85 D	Ford — Pickup Serie F-100, F-150,	90-96 T
Voyager		Lobo		Lobo	
Dodge — Pickup D y W	72-93 D	Ford — Pickup Serie F-250	80-86 D	Ford — Pickup Serie F-250	92-96 T
Dodge — Van Ram	70-93 D	Ford — Pickup Serie F-350	80-85 D		

Números de parte con P (P--) indican accesorios con la unidad



# PROGRESIVO AMORTIGADORES

## INDICE PROGRESIVO DE APLICACIONES

Vehículo	Años Pos.	Vehículo	Años Pos.	Vehículo	Años Pos.
<b>34964 (Cont.)</b> Monroe® Gas-Magnum® Amortiguador Ford — Pickup Serie F-350	(Pág. 72-74) 08-16 T 85-04 T	<b>37021 (Cont.)</b> Monroe® OESpectrum® Camionetas Ligeras Amortiguador GMC — Sonoma 2WD	(Pág. 32-33, 43, 79, 83) 82-05 T	<b>37036</b> Monroe® OESpectrum® Camionetas Ligeras Amortiguador Ford — Bronco	(Pág. 64) 80-96 D
<b>34968</b> Monroe® Magnum™ Amortiguador Nissan — Pickup Nissan — Pickup D-21	(Pág. 109) 98-09 D 65-94 D	<b>37022</b> Monroe® OESpectrum® Camionetas Ligeras Amortiguador Isuzu — Amigo Isuzu — Pickup Isuzu — Rodeo Isuzu — Trooper	(Pág. 91) 89-95 D 89-95 D 91-95 D 87-91 D	<b>37037</b> Monroe® OESpectrum® Camionetas Ligeras Amortiguador Ford — Bronco Ford — Pickup Serie F-100, F-150, Lobo	(Pág. 63-64, 71) 80-96 T 80-84 T
<b>34983</b> Monroe® Gas-Magnum® Amortiguador Chevrolet — Pickup C y R Chevrolet — Suburban Chevrolet — Van 1500 Express, Savana, Modelos G y P Chevrolet — Van Cargo Van GMC — Pickup Series C, R, K y V	(Pág. 39, 44, 47-48, 81-82) 87-00 D 92-99 D 96-02 D 97-00 D 87-02 D	<b>37024</b> Monroe® OESpectrum® Camionetas Ligeras Amortiguador Isuzu — Rodeo Isuzu — Trooper	(Pág. 91) 91-95 T 87-91 T	<b>37040</b> Monroe® OESpectrum® Camionetas Ligeras Amortiguador Chevrolet — Blazer Chevrolet — Pickup K y V Chevrolet — Suburban Chevrolet — Van 1500 Express, Savana, Modelos G y P GMC — Pickup Series C, R, K y V	(Pág. 33, 39-40, 45, 47, 82) 73-90 D 73-87 D 69-91 D 67-72 T 73-87 D
<b>34985</b> Monroe® Gas-Magnum® Amortiguador Chevrolet — Pickup K y V Chevrolet — Pickup C y R GMC — Pickup Series C, R, K y V	(Pág. 39-40, 81-82) 87-00 T 87-00 T 87-02 T	<b>37026</b> Monroe® OESpectrum® Camionetas Ligeras Amortiguador Jeep — Cherokee Jeep — Wagoneer (Grand Wagoneer) Jeep — Wrangler	(Pág. 92-94) 84-90 D 84-90 D 96-06 D	<b>37041</b> Monroe® OESpectrum® Camionetas Ligeras Amortiguador Chevrolet — Blazer Chevrolet — Pickup K y V Chevrolet — Pickup C y R Chevrolet — Suburban Chevrolet — Van 1500 Express, Savana, Modelos G y P GMC — Pickup Series C, R, K y V	(Pág. 33, 39-40, 44-45, 47, 81-82) 73-90 T 73-87 T 73-89 T 73-91 T 73-89 T 73-89 T
<b>37011</b> Monroe® OESpectrum® Camionetas Ligeras Amortiguador Ford — Ranger	(Pág. 76) 83-89 D	<b>37027</b> Monroe® OESpectrum® Camionetas Ligeras Amortiguador Jeep — Cherokee Jeep — Wagoneer (Grand Wagoneer)	(Pág. 92-93) 84-01 T 84-90 T	<b>37045</b> Monroe® OESpectrum® Camionetas Ligeras Amortiguador Dodge — Pickup D y W Dodge — Ramcharger	(Pág. 61-62) 72-93 D 74-93 D
<b>37013</b> Monroe® OESpectrum® Camionetas Ligeras Amortiguador Ford — Ranger	(Pág. 76) 83-11 T	<b>37029</b> Monroe® OESpectrum® Camionetas Ligeras Amortiguador Chevrolet — Luv Pickup Isuzu — Amigo Isuzu — Pickup Nissan — Frontier Pickup Nissan — Pathfinder	(Pág. 37, 91, 107, 109) 97-06 T 89-95 T 89-95 T 98-04 T 87-95 T	<b>37046</b> Monroe® OESpectrum® Camionetas Ligeras Amortiguador Dodge — Pickup D y W Dodge — Ramcharger	(Pág. 61-62) 72-93 T 76-93 T
<b>37014</b> Monroe® OESpectrum® Camionetas Ligeras Amortiguador Ford — Ranger	(Pág. 76) 83-11 T	<b>37030</b> Monroe® OESpectrum® Camionetas Ligeras Amortiguador Toyota — 4 Runner Toyota — Hilux Toyota — Pickup Compact Toyota — Pickup T100	(Pág. 123, 127-128) 86-95 D 04-11 D 86-95 D 93-98 D	<b>37047</b> Monroe® OESpectrum® Camionetas Ligeras Amortiguador Chevrolet — Luv Pickup Nissan — Frontier Pickup Nissan — NP300 Nissan — Pickup Nissan — Pickup D-21	(Pág. 37, 107, 109) 97-06 D 98-04 D 09-14 D 95-97 D 65-94 D
<b>37015</b> Monroe® OESpectrum® Camionetas Ligeras Amortiguador Ford — Explorer Ford — Ranger	(Pág. 66-67, 76) 91-94 D 90-97 D	<b>37031</b> Monroe® OESpectrum® Camionetas Ligeras Amortiguador Toyota — 4 Runner	(Pág. 123) 84-85 D	<b>37049</b> Monroe® OESpectrum® Camionetas Ligeras Amortiguador Chevrolet — Pickup C y R Chevrolet — Suburban Chevrolet — Van 1500 Express, Savana, Modelos G y P GMC — Pickup Series C, R, K y V	(Pág. 39, 44, 47, 81-82) 63-89 D 73-91 D 63-89 D 63-89 D
<b>37016</b> Monroe® OESpectrum® Camionetas Ligeras Amortiguador Mazda — Pickup B2600	(Pág. 101) 87-93 D	<b>37032</b> Monroe® OESpectrum® Camionetas Ligeras Amortiguador Toyota — 4 Runner Toyota — Pickup Compact	(Pág. 123, 128) 84-89 T 86-95 T		
<b>37017</b> Monroe® OESpectrum® Camionetas Ligeras Amortiguador Mazda — Pickup B2600	(Pág. 101) 87-93 T	<b>37033</b> Monroe® OESpectrum® Camionetas Ligeras Amortiguador Toyota — 4 Runner	(Pág. 123) 90-95 T		
<b>37019</b> Monroe® OESpectrum® Camionetas Ligeras Amortiguador Chevrolet — Blazer Chevrolet — S-10 GMC — Sonoma 2WD	(Pág. 32, 43, 83) 83-93 D 82-93 D 82-93 D				
<b>37021</b> Monroe® OESpectrum® Camionetas Ligeras Amortiguador Chevrolet — Blazer Chevrolet — S-10 GMC — Envoy	(Pág. 32-33, 43, 79, 83) 83-05 T 82-05 T 98-01 T				

Números de parte con P (P--) indican accesorios con la unidad



# PROGRESIVO AMORTIGADORES

## INDICE PROGRESIVO DE APLICACIONES

Vehículo	Años Pos.	Vehículo	Años Pos.	Vehículo	Años Pos.
<b>37052</b>	(Pág. 71-74)	<b>37074</b>	(Pág. 129)	<b>37099</b>	(Pág. 33, 43, 79, 83)
Monroe® OESpectrum® Camionetas Ligeras Amortiguador		Monroe® OESpectrum® Camionetas Ligeras Amortiguador		Monroe® OESpectrum® Camionetas Ligeras Amortiguador	
Ford — Pickup Serie F-100, F-150, Lobo	85-96 T	Toyota — Previa (Van)	90-97 TD	Chevrolet — Blazer	83-05 D
Ford — Pickup Serie F-250	80-96 T		90-97 TI	Chevrolet — S-10	83-05 D
Ford — Pickup Serie F-350	99-16 T	<b>37077</b>	(Pág. 107, 109)	GMC — Envoy	98-01 D
	80-86 T	Monroe® OESpectrum® Camionetas Ligeras Amortiguador		GMC — Sonoma 2WD	83-05 D
<b>37058</b>	(Pág. 63)	Nissan — Frontier Pickup	98-02 D	<b>37100</b>	(Pág. 109)
Monroe® OESpectrum® Camionetas Ligeras Amortiguador		Nissan — Pickup	95-97 D	Monroe® OESpectrum® Camionetas Ligeras Amortiguador	
Ford — Aerostar (Mini) Van	86-97 D	Nissan — Pickup D-21	65-94 D	Nissan — Pathfinder	87-95 D
<b>37061</b>	(Pág. 63)	<b>37078</b>	(Pág. 107, 109)	<b>37101</b>	(Pág. 128)
Monroe® OESpectrum® Camionetas Ligeras Amortiguador		Monroe® OESpectrum® Camionetas Ligeras Amortiguador		Monroe® OESpectrum® Camionetas Ligeras Amortiguador	
Ford — Aerostar (Mini) Van	89-97 T	Nissan — Frontier Pickup	98-02 T	Toyota — Pickup T100	93-98 T
<b>37062</b>	(Pág. 32)	Nissan — Pickup	95-97 T	<b>37110</b>	(Pág. 69, 78)
Monroe® OESpectrum® Camionetas Ligeras Amortiguador		Nissan — Pickup D-21	65-94 T	Monroe® OESpectrum® Camionetas Ligeras Amortiguador	
Chevrolet — Astro (Mini Van)	90-05 D	<b>37081</b>	(Pág. 93)	Ford — Freestar (Mini Van)	04-07 T
<b>37063</b>	(Pág. 32, 128)	Monroe® OESpectrum® Camionetas Ligeras Amortiguador		Ford — Windstar (Mini Van)	94-03 T
Monroe® OESpectrum® Camionetas Ligeras Amortiguador		Jeep — Grand Cherokee	93-98 D	<b>37111</b>	(Pág. 132)
Chevrolet — Astro (Mini Van)	85-05 D	<b>37082</b>	(Pág. 93)	Monroe® OESpectrum® Camionetas Ligeras Amortiguador	
Toyota — Pickup T100	93-98 D	Monroe® OESpectrum® Camionetas Ligeras Amortiguador		Toyota — Tacoma	95-04 D
<b>37064</b>	(Pág. 32)	Jeep — Grand Cherokee	93-98 T	<b>37112</b>	(Pág. 132)
Monroe® OESpectrum® Camionetas Ligeras Amortiguador		<b>37083</b>	(Pág. 92)	Monroe® OESpectrum® Camionetas Ligeras Amortiguador	
Chevrolet — Astro (Mini Van)	85-05 T	Monroe® OESpectrum® Camionetas Ligeras Amortiguador		Toyota — Tacoma	95-04 T
<b>37065</b>	(Pág. 52, 55)	Jeep — Cherokee	91-01 D	<b>37113</b>	(Pág. 132)
Monroe® OESpectrum® Camionetas Ligeras Amortiguador		<b>37086</b>	(Pág. 31)	Monroe® OESpectrum® Camionetas Ligeras Amortiguador	
Chrysler — Town & Country	90-95 T	Monroe® OESpectrum® Camionetas Ligeras Amortiguador		Toyota — Tacoma	95-04 TD
Chrysler — Voyager y Grand Voyager	84-94 T	Cadillac — Escalade	99-00 T	<b>37114</b>	(Pág. 132)
Dodge — Caravan y Grand Caravan	86-95 T	<b>37091</b>	(Pág. 47, 53)	Monroe® OESpectrum® Camionetas Ligeras Amortiguador	
<b>37066</b>	(Pág. 56)	Monroe® OESpectrum® Camionetas Ligeras Amortiguador		Toyota — Tacoma	95-04 TI
Monroe® OESpectrum® Camionetas Ligeras Amortiguador		Chevrolet — Van 1500 Express, Savana, Modelos G y P	78-95 T	<b>37116</b>	(Pág. 78)
Dodge — Dakota	87-96 D	Chrysler — Voyager y Grand Voyager	74-83 T	Monroe® OESpectrum® Camionetas Ligeras Amortiguador	
<b>37067</b>	(Pág. 56)	<b>37094</b>	(Pág. 61-62)	Ford — Van Serie E	08-14 D
Monroe® OESpectrum® Camionetas Ligeras Amortiguador		Monroe® OESpectrum® Camionetas Ligeras Amortiguador			92-06 D
Dodge — Dakota	87-96 T	Dodge — Pickup D y W	72-93 T	<b>37117</b>	(Pág. 78)
<b>37070</b>	(Pág. 46)	Dodge — Ramcharger	74-93 T	Monroe® OESpectrum® Camionetas Ligeras Amortiguador	
Monroe® OESpectrum® Camionetas Ligeras Amortiguador		<b>37096</b>	(Pág. 53, 61)	Ford — Van Serie E	08-14 T
Chevrolet — Tracker	98-04 TD	Monroe® OESpectrum® Camionetas Ligeras Amortiguador			92-06 T
	98-04 TI	Chrysler — Voyager y Grand Voyager	74-83 D	<b>37120</b>	(Pág. 94)
	89-92 T	Dodge — Pickup D y W	72-93 D	Monroe® OESpectrum® Camionetas Ligeras Amortiguador	
<b>37073</b>	(Pág. 107, 109, 128)	<b>37098</b>	(Pág. 103, 110)	Jeep — Wrangler	87-95 D
Monroe® OESpectrum® Camionetas Ligeras Amortiguador		Monroe® OESpectrum® Camionetas Ligeras Amortiguador		<b>37121</b>	(Pág. 94)
Nissan — Frontier Pickup	98-03 T	Mercury — Villager	99-02 T	Monroe® OESpectrum® Camionetas Ligeras Amortiguador	
Nissan — Pickup	95-97 T		93-98 TD	Jeep — Wrangler	87-95 T
Nissan — Pickup D-21	65-94 T	Nissan — Quest (Mini Van)	93-03 TD	<b>37122</b>	(Pág. 67, 76)
Toyota — Pickup T100	93-98 T		93-03 TI	Monroe® OESpectrum® Camionetas Ligeras Amortiguador	
			93-03 TI	Ford — Explorer	95-06 D

Números de parte con P (P--) indican accesorios con la unidad



# PROGRESIVO AMORTIGUADORES

## INDICE PROGRESIVO DE APLICACIONES

Vehículo	Años Pos.	Vehículo	Años Pos.	Vehículo	Años Pos.
<b>37122 (Cont.)</b> Monroe® OESpectrum® Camionetas Ligeras Amortiguador Ford — Ranger	(Pág. 67, 76) 98-11 D	<b>37156</b> Monroe® OESpectrum® Camionetas Ligeras Amortiguador Chevrolet — Uplander Chevrolet — Venture (Mini Van) AWD Oldsmobile — Silhouette Pontiac — Aztek AWD	(Pág. 47-48, 114-115) 05-09 T 97-05 T 97-05 T 01-05 T	<b>37181</b> Monroe® OESpectrum® Camionetas Ligeras Amortiguador Chevrolet — Avalanche Chevrolet — Pickup Silverado	(Pág. 32, 41) 02-06 D 05-07 D 01-03 D
<b>37123</b> Monroe® OESpectrum® Camionetas Ligeras Amortiguador Chrysler — Town & Country Chrysler — Voyager y Grand Voyager Dodge — Caravan y Grand Caravan	(Pág. 52, 54-55) 95-07 T 95-07 T 95-07 T	<b>37157</b> Monroe® OESpectrum® Camionetas Ligeras Amortiguador Toyota — 4 Runner	(Pág. 123) 96-02 T	<b>37183</b> Monroe® OESpectrum® Camionetas Ligeras Amortiguador Toyota — Land Cruiser	(Pág. 127) 98-07 D
<b>37129</b> Monroe® OESpectrum® Camionetas Ligeras Amortiguador Chevrolet — Blazer Chevrolet — S-10 GMC — Envoy GMC — Sonoma 2WD	(Pág. 32, 43, 79, 83) 94-05 D 94-05 D 00-01 D 94-05 D	<b>37158</b> Monroe® OESpectrum® Camionetas Ligeras Amortiguador Nissan — Pathfinder	(Pág. 109) 96-98 TD 96-98 TI	<b>37184</b> Monroe® OESpectrum® Camionetas Ligeras Amortiguador Toyota — Land Cruiser	(Pág. 127) 98-07 T
<b>37131</b> Monroe® OESpectrum® Camionetas Ligeras Amortiguador Ford — Expedition Lincoln — Navigator	(Pág. 66, 71, 98) 97-02 D 98-02 D	<b>37159</b> Monroe® OESpectrum® Camionetas Ligeras Amortiguador Isuzu — Amigo	(Pág. 91) 98-00 D	<b>37195</b> Monroe® OESpectrum® Camionetas Ligeras Amortiguador Volkswagen — Van Eurovan	(Pág. 137) 93-04 D
<b>37135</b> Monroe® OESpectrum® Camionetas Ligeras Amortiguador Jeep — Wrangler	(Pág. 94) 96-06 T	<b>37160</b> Monroe® OESpectrum® Camionetas Ligeras Amortiguador Isuzu — Amigo	(Pág. 91) 98-00 T	<b>37199</b> Monroe® OESpectrum® Camionetas Ligeras Amortiguador Toyota — RAV4	(Pág. 130) 96-05 TD 96-05 TI
<b>37137</b> Monroe® OESpectrum® Camionetas Ligeras Amortiguador Dodge — Dakota Dodge — Durango	(Pág. 56-57) 97-04 D 99-03 D	<b>37161</b> Monroe® OESpectrum® Camionetas Ligeras Amortiguador Jeep — Grand Cherokee	(Pág. 93) 99-04 D	<b>37202</b> Monroe® OESpectrum® Camionetas Ligeras Amortiguador Ford — Expedition Lincoln — Navigator	(Pág. 66, 98) 97-02 T 98-02 T
<b>37138</b> Monroe® OESpectrum® Camionetas Ligeras Amortiguador Dodge — Dakota Dodge — Durango	(Pág. 56-57) 97-04 T 99-03 T	<b>37162</b> Monroe® OESpectrum® Camionetas Ligeras Amortiguador Jeep — Grand Cherokee	(Pág. 93) 99-04 T	<b>37203</b> Monroe® OESpectrum® Camionetas Ligeras Amortiguador Dodge — Nitro Jeep — Liberty	(Pág. 58, 93) 07-12 TD 07-12 TI 02-12 TD 02-12 TI
<b>37147</b> Monroe® OESpectrum® Camionetas Ligeras Amortiguador Ford — Pickup Serie F-100, F-150, Lobo Ford — Pickup Serie F-250	(Pág. 71-72) 00-04 T 97-99 T	<b>37163</b> Monroe® OESpectrum® Camionetas Ligeras Amortiguador Chevrolet — Pickup Silverado Chevrolet — Suburban GMC — Pickup Sierra 2500	(Pág. 42, 44, 81) 99-04 D 00-01 D 99-04 D	<b>37204</b> Monroe® OESpectrum® Camionetas Ligeras Amortiguador Nissan — Pathfinder	(Pág. 109) 02-03 T 98-01 TD 98-01 TI
<b>37148</b> Monroe® OESpectrum® Camionetas Ligeras Amortiguador Ford — Pickup Serie F-250	(Pág. 73) 97-99 T	<b>37164</b> Monroe® OESpectrum® Camionetas Ligeras Amortiguador Chevrolet — Pickup Silverado GMC — Pickup Sierra 2500	(Pág. 41-42, 81) 99-07 T 99-10 T	<b>37217</b> Monroe® OESpectrum® Camionetas Ligeras Amortiguador Ford — Escape Mercury — Mariner	(Pág. 65, 102) 01-07 TD 01-07 TI 05-07 TD 05-07 TI
<b>37153</b> Monroe® OESpectrum® Camionetas Ligeras Amortiguador Ford — Ranger	(Pág. 76) 98-11 D	<b>37171</b> Monroe® OESpectrum® Camionetas Ligeras Amortiguador Nissan — Xterra	(Pág. 112) 00-01 D	<b>37218</b> Monroe® OESpectrum® Camionetas Ligeras Amortiguador Honda — Odyssey (Mini Van)	(Pág. 87) 99-04 TD 99-04 TI
<b>37154</b> Monroe® OESpectrum® Camionetas Ligeras Amortiguador Ford — Expedition Lincoln — Navigator	(Pág. 66, 98) 97-02 T 98-02 T	<b>37172</b> Monroe® OESpectrum® Camionetas Ligeras Amortiguador Nissan — Xterra	(Pág. 112) 00-04 T	<b>37219</b> Monroe® OESpectrum® Camionetas Ligeras Amortiguador Mercedes Benz — Clase M (SUV)	(Pág. 102) 98-05 D
		<b>37177</b> Monroe® OESpectrum® Camionetas Ligeras Amortiguador Ford — Explorer	(Pág. 66-67) 95-06 D		

Números de parte con P (P--) indican accesorios con la unidad



# PROGRESIVO AMORTIGUADORES

## INDICE PROGRESIVO DE APLICACIONES

Vehículo	Años Pos.	Vehículo	Años Pos.	Vehículo	Años Pos.
<b>37225</b>	(Pág. 105)	<b>37251</b>	(Pág. 111)	<b>37283</b>	(Pág. 110)
Monroe® OESpectrum® Camionetas Ligeras Amortiguador		Monroe® OESpectrum® Camionetas Ligeras Amortiguador		Monroe® OESpectrum® Camionetas Ligeras Amortiguador	
Mitsubishi — Montero	00-04 D	Nissan — Titan Pickup	04-15 T	Nissan — Quest (Mini Van)	04-09 TD
<b>37226</b>	(Pág. 105)	<b>37252</b>	(Pág. 111)		04-09 TI
Monroe® OESpectrum® Camionetas Ligeras Amortiguador		Monroe® OESpectrum® Camionetas Ligeras Amortiguador		<b>37284</b>	(Pág. 130-131)
Mitsubishi — Montero	00-04 T	Nissan — Titan Pickup	04-15 T	Monroe® OESpectrum® Camionetas Ligeras Amortiguador	
<b>37234</b>	(Pág. 96)	<b>37253</b>	(Pág. 106)	Toyota — Sienna	04-14 TD
Monroe® OESpectrum® Camionetas Ligeras Amortiguador		Monroe® OESpectrum® Camionetas Ligeras Amortiguador			04-14 TI
Land Rover — Discovery	99-04 T	Nissan — Armada	05-15 T	<b>37285</b>	(Pág. 94)
<b>37237</b>	(Pág. 89)	<b>37270</b>	(Pág. 123, 126)	Monroe® OESpectrum® Camionetas Ligeras Amortiguador	
Monroe® OESpectrum® Camionetas Ligeras Amortiguador		Monroe® OESpectrum® Camionetas Ligeras Amortiguador		Jeep — Wrangler	07-18 D
Hyundai — Santa Fe	01-06 TD	Toyota — FJ Cruiser	07-13 T	<b>37286</b>	(Pág. 94)
	01-06 TI	<b>37272</b>	(Pág. 95)	Monroe® OESpectrum® Camionetas Ligeras Amortiguador	
<b>37238</b>	(Pág. 133)	Monroe® OESpectrum® Camionetas Ligeras Amortiguador		Jeep — Wrangler	07-10 T
Monroe® OESpectrum® Camionetas Ligeras Amortiguador		Kia — Sedona	02-05 TD	<b>37287</b>	(Pág. 94)
Toyota — Tundra	00-06 T		02-05 TI	Monroe® OESpectrum® Camionetas Ligeras Amortiguador	
<b>37239</b>	(Pág. 132)	<b>37273</b>	(Pág. 107)	Jeep — Wrangler	07-18 T
Monroe® OESpectrum® Camionetas Ligeras Amortiguador		Monroe® OESpectrum® Camionetas Ligeras Amortiguador		<b>37289</b>	(Pág. 129-130)
Toyota — Tundra	00-06 T	Nissan — Frontier Pickup	05-19 T	Monroe® OESpectrum® Camionetas Ligeras Amortiguador	
<b>37241</b>	(Pág. 46, 79)	<b>37274</b>	(Pág. 109)	Toyota — RAV4	06-18 TD
Monroe® OESpectrum® Camionetas Ligeras Amortiguador		Monroe® OESpectrum® Camionetas Ligeras Amortiguador			06-18 TI
Chevrolet — Trailblazer	02-09 T	Nissan — Pathfinder	05-12 T	<b>37290</b>	(Pág. 51, 52, 54, 62, 137)
GMC — Envoy	02-09 T	<b>37275</b>	(Pág. 112)	Monroe® OESpectrum® Camionetas Ligeras Amortiguador	
<b>37242</b>	(Pág. 46, 79)	Monroe® OESpectrum® Camionetas Ligeras Amortiguador		Chrysler — Town & Country	08-16 T
Monroe® OESpectrum® Camionetas Ligeras Amortiguador		Nissan — Xterra	05-15 T	Chrysler — Voyager y Grand Voyager	12-16 T
Chevrolet — Trailblazer	02-09 T	<b>37276</b>	(Pág. 112)	Dodge — Caravan y Grand Caravan	08-16 T
GMC — Envoy	02-09 T	Monroe® OESpectrum® Camionetas Ligeras Amortiguador		Dodge — Ram Cargo Caravan (C/V)	12-15 T
<b>37243</b>	(Pág. 131)	Nissan — Xterra	05-15 T	Volkswagen — Routan	09-12 T
Monroe® OESpectrum® Camionetas Ligeras Amortiguador		<b>37279</b>	(Pág. 132)	<b>37301</b>	(Pág. 130-131)
Toyota — Sienna	98-03 TD	Monroe® OESpectrum® Camionetas Ligeras Amortiguador		Monroe® OESpectrum® Camionetas Ligeras Amortiguador	
	98-03 TI	Toyota — Tacoma	05-15 TD	Toyota — Sienna	04-14 TD
<b>37245</b>	(Pág. 107, 112)		05-15 TI		04-14 TI
Monroe® OESpectrum® Camionetas Ligeras Amortiguador		<b>37280</b>	(Pág. 132)		04-06 T
Nissan — Frontier Pickup	03-04 D	Monroe® OESpectrum® Camionetas Ligeras Amortiguador		<b>37302</b>	(Pág. 65, 98)
Nissan — Xterra	02-04 D	Toyota — Tacoma	05-15 T	Monroe® OESpectrum® Camionetas Ligeras Amortiguador	
<b>37246</b>	(Pág. 87)	<b>37281</b>	(Pág. 96)	Ford — Edge	07-10 TD
Monroe® OESpectrum® Camionetas Ligeras Amortiguador		Monroe® OESpectrum® Camionetas Ligeras Amortiguador			07-10 TI
Honda — Pilot	06-08 TD	Kia — Sorento	03-06 TD	Lincoln — MKX	07-09 TD
	06-08 TI		03-06 TI		07-09 TI
	03-05 T	<b>37282</b>	(Pág. 108)	<b>37307</b>	(Pág. 88, 95)
<b>37250</b>	(Pág. 105)	Monroe® OESpectrum® Camionetas Ligeras Amortiguador		Monroe® OESpectrum® Camionetas Ligeras Amortiguador	
Monroe® OESpectrum® Camionetas Ligeras Amortiguador		Nissan — Murano	03-08 TD	Hyundai — Entourage	07-08 TD
Mitsubishi — Montero	01-03 T		03-08 TI		07-08 TI
				Kia — Sedona	06-12 TD
					06-12 TI

Números de parte con P (P--) indican accesorios con la unidad



# PROGRESIVO AMORTIGUADORES

## INDICE PROGRESIVO DE APLICACIONES

Vehículo	Años Pos.	Vehículo	Años Pos.	Vehículo	Años Pos.
<b>37308</b> Monroe® OESpectrum® Camionetas Ligeras Amortiguador	(Pág. 123) 06-17 TD 06-17 TI	<b>37322 (Cont.)</b> Monroe® OESpectrum® Camionetas Ligeras Amortiguador	(Pág. 89-90, 95) 07-12 T 11-13 TD 11-13 TI	<b>37341 (Cont.)</b> Monroe® OESpectrum® Camionetas Ligeras Amortiguador	(Pág. 88-89, 96) 11-16 T
Suzuki — Grand Vitara		Hyundai — Veracruz		Kia — Sportage	
<b>37309</b> Monroe® OESpectrum® Camionetas Ligeras Amortiguador	(Pág. 23) 07-13 TD 07-13 TI	<b>37323</b> Monroe® OESpectrum® Camionetas Ligeras Amortiguador	(Pág. 95) 07-09 TD 07-09 TI	<b>37342</b> Monroe® OESpectrum® Camionetas Ligeras Amortiguador	(Pág. 127) 13-15 T 08-11 T
Acura — MDX		Kia — Sorento		Toyota — Land Cruiser	
<b>37310</b> Monroe® OESpectrum® Camionetas Ligeras Amortiguador	(Pág. 105) 07-13 TD 07-13 TI	<b>37327</b> Monroe® OESpectrum® Camionetas Ligeras Amortiguador	(Pág. 64, 98) 11-14 TD 11-14 TI 11-15 TD 11-15 TI	<b>37343</b> Monroe® OESpectrum® Camionetas Ligeras Amortiguador	(Pág. 89, 96) 10-15 T 11-16 T
Mitsubishi — Outlander		Ford — Edge		Hyundai — Tucson	
<b>37311</b> Monroe® OESpectrum® Camionetas Ligeras Amortiguador	(Pág. 77) 10-13 T 99-01 T	Lincoln — MKX		Kia — Sportage	
Ford — Transit		<b>37328</b> Monroe® OESpectrum® Camionetas Ligeras Amortiguador	(Pág. 110, 113, 118) 08-14 TD 08-14 TI	<b>37345</b> Monroe® OESpectrum® Camionetas Ligeras Amortiguador	(Pág. 77) 14-18 TD 14-18 TI
<b>37315</b> Monroe® OESpectrum® Camionetas Ligeras Amortiguador	(Pág. 29, 47, 78) 08-17 T 09-17 T 07-16 T	Nissan — Rogue		<b>37346</b> Monroe® OESpectrum® Camionetas Ligeras Amortiguador	(Pág. 28) 07-13 TD
Buick — Enclave		<b>37329</b> Monroe® OESpectrum® Camionetas Ligeras Amortiguador	(Pág. 68, 98) 13-19 T 08-09 TD 08-09 TI	BMW — X5	
Chevrolet — Traverse		Ford — Flex		<b>37347</b> Monroe® OESpectrum® Camionetas Ligeras Amortiguador	(Pág. 28) 07-13 TI
GMC — Acadia		Lincoln — MKT		BMW — X5	
<b>37316</b> Monroe® OESpectrum® Camionetas Ligeras Amortiguador	(Pág. 87) 13-17 T 05-12 TD 05-12 TI	<b>37331</b> Monroe® OESpectrum® Camionetas Ligeras Amortiguador	(Pág. 101) 07-15 TD 07-15 TI	<b>37348</b> Monroe® OESpectrum® Camionetas Ligeras Amortiguador	(Pág. 137) 80-91 D
Honda — Odyssey (Mini Van)		Mazda — CX-9		Volkswagen — Van Vanagon	
<b>37317</b> Monroe® OESpectrum® Camionetas Ligeras Amortiguador	(Pág. 108) 09-13 TD 09-13 TI	<b>37334</b> Monroe® OESpectrum® Camionetas Ligeras Amortiguador	(Pág. 34, 109) 15-18 TD 15-18 TI	<b>37349</b> Monroe® OESpectrum® Camionetas Ligeras Amortiguador	(Pág. 137) 80-91 T
Nissan — Murano		Chevrolet — City Express		Volkswagen — Van Vanagon	
<b>37318</b> Monroe® OESpectrum® Camionetas Ligeras Amortiguador	(Pág. 65, 102) 08-12 TD 08-12 TI 08-11 TD 08-11 TI	<b>37336</b> Monroe® OESpectrum® Camionetas Ligeras Amortiguador	(Pág. 107) 11-17 T	<b>37350</b> Monroe® OESpectrum® Camionetas Ligeras Amortiguador	(Pág. 31) 10-15 T
Ford — Escape		Nissan — Juke		Cadillac — SRX	
Mercury — Mariner		<b>37338</b> Monroe® OESpectrum® Camionetas Ligeras Amortiguador	(Pág. 100) 09-15 TD 09-15 TI	<b>37351</b> Monroe® OESpectrum® Camionetas Ligeras Amortiguador	(Pág. 34-35, 78-79) 15-18 T
<b>37319</b> Monroe® OESpectrum® Amortiguador	(Pág. 134, 137) 12-13 T 05-09 T	Mazda — CX-7		<b>37352</b> Monroe® OESpectrum® Camionetas Ligeras Amortiguador	(Pág. 107) 11-16 T
Volkswagen — Crafter		<b>37339</b> Monroe® OESpectrum® Camionetas Ligeras Amortiguador	(Pág. 87) 09-15 TD 09-15 TI	Nissan — Juke	
Volkswagen — Eurovan TDI		Honda — Pilot		<b>37355</b> Monroe® OESpectrum® Camionetas Ligeras Amortiguador	(Pág. 133) 10-18 T
<b>37320</b> Monroe® OESpectrum® Amortiguador	(Pág. 112) 00-13 T	<b>37341</b> Monroe® OESpectrum® Camionetas Ligeras Amortiguador	(Pág. 88-89, 96) 10-15 T	Volkswagen — Amarok	
Nissan — Urvan		Hyundai — Tucson		<b>37356</b> Monroe® OESpectrum® Camionetas Ligeras Amortiguador	(Pág. 64) 06-12 TD 06-12 TI

Números de parte con P (P--) indican accesorios con la unidad



# PROGRESIVO AMORTIGUADORES

## INDICE PROGRESIVO DE APLICACIONES

Vehículo	Años Pos.	Vehículo	Años Pos.	Vehículo	Años Pos.
<b>37357</b>	(Pág. 109)	<b>37372</b>	(Pág. 126)	<b>39051</b>	(Pág. 28)
Monroe® OESpectrum® Camionetas Ligeras Amortiguador		Monroe® OESpectrum® Amortiguador		Monroe® OESpectrum® Monotubo Amortiguador	
Nissan — Quest (Mini Van)	11-17 T	Toyota — Hiace	06-18 D	BMW — X5	00-06 T
<b>37358</b>	(Pág. 92)	<b>37373</b>	(Pág. 126)	<b>39052</b>	(Pág. 115)
Monroe® OESpectrum® Camionetas Ligeras Amortiguador		Monroe® OESpectrum® Amortiguador		Monroe® OESpectrum® Monotubo Amortiguador	
Jeep — Cherokee	14-18 TD	Toyota — Hiace	06-18 T	Pontiac — Aztek AWD	01-05 T
	14-18 TI	<b>37375</b>	(Pág. 77)	<b>39102</b>	(Pág. 24, 136)
<b>37359</b>	(Pág. 33)	Monroe® OESpectrum® Amortiguador		Monroe® OESpectrum® Monotubo Amortiguador	
Monroe® OESpectrum® Camionetas Ligeras Amortiguador		Ford — Transit	06-15 T	Audi — A6	99-04 T
Chevrolet — Captiva Sport	12-15 TD	<b>37376</b>	(Pág. 90)	Volkswagen — Passat	98-05 T
	12-15 TI	Monroe® OESpectrum® Camionetas Ligeras Amortiguador		<b>39104</b>	(Pág. 32, 44-45, 46, 83)
<b>37360</b>	(Pág. 64)	Infiniti — EX35	08-12 T	Monroe® OESpectrum® Monotubo Amortiguador	
Monroe® OESpectrum® Amortiguador		<b>37377</b>	(Pág. 88)	Chevrolet — Avalanche	07-13 D
Ford — EcoSport	06-12 T	Monroe® OESpectrum® Camionetas Ligeras Amortiguador		Chevrolet — Suburban	07-14 D
<b>37361</b>	(Pág. 97, 126)	Hyundai — Santa Fe	13-18 TD	Chevrolet — Tahoe	07-14 D
Monroe® OESpectrum® Camionetas Ligeras Amortiguador			13-18 TI	GMC — Yukon	07-14 D
Lexus — RX350	10-15 TD	<b>37378</b>	(Pág. 64, 98)	<b>39105</b>	(Pág. 39, 40-41, 79-80)
	10-15 TI	Monroe® OESpectrum® Camionetas Ligeras Amortiguador		Monroe® OESpectrum® Monotubo Amortiguador	
Toyota — Highlander	14-19 TD	Ford — Edge	15-18 T	Chevrolet — Pickup Cheyenne	07-16 D
	14-19 TI	Lincoln — MKX	16-18 T	Chevrolet — Pickup Silverado	07-13 D
<b>37362</b>	(Pág. 118)	<b>37379</b>	(Pág. 88)	GMC — Pickup Sierra 1500	07-13 D
Monroe® OESpectrum® Camionetas Ligeras Amortiguador		Monroe® OESpectrum® Amortiguador		<b>39107</b>	(Pág. 28)
RAM — Serie Promaster	15-19 TD	Hyundai — Santa Fe	13-18 TD	Monroe® OESpectrum® Monotubo Amortiguador	
	15-19 TI		13-18 TI	BMW — X3	04-11 TD
<b>37363</b>	(Pág. 109)	<b>37382</b>	(Pág. 85)		04-11 TI
Monroe® OESpectrum® Camionetas Ligeras Amortiguador		Monroe® OESpectrum® Amortiguador		<b>39108</b>	(Pág. 101)
Nissan — Pathfinder	13-19 TD	Honda — CR-V	17-19 TD	Monroe® OESpectrum® Monotubo Amortiguador	
	13-19 TI		17-19 TI	Mercedes Benz — Clase E	03-09 T
<b>37365</b>	(Pág. 90)	<b>37386</b>	(Pág. 89)	<b>39109</b>	(Pág. 102)
Monroe® OESpectrum® Camionetas Ligeras Amortiguador		Monroe® OESpectrum® Amortiguador		Monroe® OESpectrum® Monotubo Amortiguador	
Infiniti — EX35	09-12 TD	Hyundai — Tucson	16-17 T	Mercedes Benz — Clase E	03-09 T
	09-12 TI	<b>39013</b>	(Pág. 101)	<b>39110</b>	(Pág. 101-102)
Infiniti — FX50	09-11 TD	Monroe® OESpectrum® Monotubo Amortiguador		Monroe® OESpectrum® Monotubo Amortiguador	
	09-11 TI	Mercedes Benz — Clase C	93-00 D	Mercedes Benz — Clase E	03-09 D
<b>37367</b>	(Pág. 77)	<b>39040</b>	(Pág. 138)	<b>39111</b>	(Pág. 65)
Monroe® OESpectrum® Amortiguador		Monroe® OESpectrum® Monotubo Amortiguador		Monroe® OESpectrum® Monotubo Amortiguador	
Ford — Transit	06-15 T	Volvo — S60	01-09 T	Mercedes Benz — Clase E	03-09 D
<b>37368</b>	(Pág. 88)	Volvo — S80	99-06 T	<b>39112</b>	(Pág. 40-41, 43-44, 46, 79-80, 83)
Monroe® OESpectrum® Amortiguador		Volvo — V70	00-07 T	Monroe® OESpectrum® Monotubo Amortiguador	
Hyundai — H100	06-14 D	<b>39044</b>	(Pág. 102)	Ford — Escape	2019 TD
<b>37369</b>	(Pág. 88)	Monroe® OESpectrum® Monotubo Amortiguador			2019 TI
Monroe® OESpectrum® Amortiguador		Mercedes Benz — Clase SLK	97-04 D		2013 TD
Hyundai — H100	06-14 T	<b>39045</b>	(Pág. 102)		2013 TI
<b>37370</b>	(Pág. 113)	Monroe® OESpectrum® Monotubo Amortiguador		<b>39112</b>	(Pág. 40-41, 43-44, 46, 79-80, 83)
Monroe® OESpectrum® Amortiguador		Mercedes Benz — Clase SLK	97-04 T	Monroe® OESpectrum® Monotubo Amortiguador	
Nissan — X-Trail	08-14 TD	<b>39047</b>	(Pág. 101)	Chevrolet — Pickup Silverado	14-18 D
	08-14 TI	Monroe® OESpectrum® Monotubo Amortiguador		Chevrolet — Suburban	15-18 D
<b>37371</b>	(Pág. 118)	Mercedes Benz — Clase C	00-07 T	Chevrolet — Tahoe	15-18 D
Monroe® OESpectrum® Amortiguador				GMC — Pickup Sierra 1500	14-18 D
Renault — Duster	12-18 TD				
	12-18 TI				

Números de parte con P (P--) indican accesorios con la unidad





# PROGRESIVO AMORTIGUADORES

## INDICE PROGRESIVO DE APLICACIONES

Vehículo	Años Pos.	Vehículo	Años Pos.	Vehículo	Años Pos.
<b>39114</b>	(Pág. 31, 118)	<b>40209</b>	(Pág. 44)	<b>58648 (Cont.)</b>	(Pág. 51-52, 54, 62)
Monroe® OESpectrum® Monotubo Amortiguador		Monroe® Specialty™ Amortiguador		Monroe® Load Adjusting Amortiguador	
Cadillac — CTS	03-13 T	Chevrolet — Suburban	00-06 T	Chrysler — Voyager y Grand Voyager	12-16 T
Renault — Laguna	03-06 T	<b>40210</b>	(Pág. 43, 46, 83)	Dodge — Caravan y Grand Caravan	08-16 T
<b>39134</b>	(Pág. 31)	Monroe® Specialty™ Amortiguador		Dodge — Ram Cargo Caravan (C/V)	12-15 T
Monroe® OESpectrum® Strut		Chevrolet — Sonora	01-06 T	<b>58651</b>	(Pág. 53, 57)
Cadillac — SRX	04-09 D	Chevrolet — Tahoe	01-06 T	Monroe® Load Adjusting Amortiguador	
<b>39135</b>	(Pág. 31)	GMC — Yukon	01-06 T	Dodge — Aspen	06-09 T
Monroe® OESpectrum® Strut		<b>40212</b>	(Pág. 49, 55)	Dodge — Durango	04-09 T
Cadillac — STS	05-09 D	Monroe® Specialty™ Amortiguador		<b>58653</b>	(Pág. 72)
<b>40034</b>	(Pág. 31, 43, 46, 83)	Chrysler — 300, 300C y 300M	05-10 T	Monroe® Load Adjusting Amortiguador	
Monroe® Specialty™ Amortiguador		Dodge — Charger	06-10 T	Ford — Pickup Serie F-100, F-150, Lobo	09-13 T
Cadillac — Escalade	02-06 T	<b>58523</b>	(Pág. 32-33)	<b>58654</b>	(Pág. 40-41, 79-80)
Chevrolet — Sonora	01-06 T	Monroe® Load Adjusting Amortiguador		Monroe® Load Adjusting Amortiguador	
Chevrolet — Tahoe	01-06 T	Chevrolet — Blazer	83-05 T	Chevrolet — Pickup Silverado	07-18 T
GMC — Yukon	01-06 T	<b>58612</b>	(Pág. 31)	GMC — Pickup Sierra 1500	07-18 T
<b>40038</b>	(Pág. 41, 80)	Monroe® Load Adjusting Amortiguador		<b>58656</b>	(Pág. 77)
Monroe® Specialty™ Amortiguador		Cadillac — Escalade	99-00 T	Monroe® Load Adjusting Amortiguador	
Chevrolet — Pickup Silverado	00-07 D	<b>58636</b>	(Pág. 41, 80)	Ford — Transit	15-19 T
GMC — Pickup Sierra 1500	00-07 D	Monroe® Load Adjusting Amortiguador		<b>58657</b>	(Pág. 77)
<b>40044</b>	(Pág. 31-32, 43-46, 83)	Chevrolet — Pickup Silverado	99-07 T	Monroe® Load Adjusting Amortiguador	
Monroe® Specialty™ Amortiguador		GMC — Pickup Sierra 1500	99-07 T	Ford — Transit	10-13 T
Cadillac — Escalade	02-06 D	<b>58637</b>	(Pág. 41, 80)	<b>58658</b>	(Pág. 77)
Chevrolet — Avalanche	02-06 D	Monroe® Load Adjusting Amortiguador		Monroe® Load Adjusting Amortiguador	
Chevrolet — Sonora	01-06 D	Chevrolet — Pickup Silverado	99-07 T	Ford — Transit	14-18 T
Chevrolet — Suburban	00-06 D	GMC — Pickup Sierra 1500	99-07 T	<b>63618</b>	(Pág. 49-136.)
Chevrolet — Tahoe	01-06 D	<b>58638</b>	(Pág. 41-42, 79-80, 81)	Monroe® Strut-Mate® Kit Cubrepolvos	
GMC — Yukon	01-06 D	Monroe® Load Adjusting Amortiguador		Chrysler — 300, 300C y 300M	99-04 T
<b>40047</b>	(Pág. 31)	Chevrolet — Pickup Silverado	99-07 T	Chrysler — Concorde	93-04 T
Monroe® Specialty™ Strut		GMC — Pickup Sierra 1500	05-07 T	Chrysler — LHS	94-01 T
Cadillac — Escalade	07-14 D	GMC — Pickup Sierra 2500	99-04 T	Dodge — Intrepid	93-04 T
<b>40049</b>	(Pág. 31-32, 44-45)	<b>58642</b>	(Pág. 71)	Ford — Escort	91-96 T
Monroe® Specialty™ Strut		Monroe® Load Adjusting Amortiguador		Nissan — Stanza	84-86 D
Cadillac — Escalade	07-14 D	Ford — Pickup Serie F-100, F-150, Lobo	04-08 T	Toyota — Corolla	88-02 T
Chevrolet — Avalanche	07-13 D	<b>58643</b>	(Pág. 71-72)	Toyota — Matrix	03-08 D
Chevrolet — Suburban	07-14 D	Monroe® Load Adjusting Amortiguador		Toyota — Previa (Van)	90-97 D
<b>40050</b>	(Pág. 31-32, 44-45, 83)	Ford — Pickup Serie F-100, F-150, Lobo	04-13 T	Volkswagen — Cabrio	95-02 D
Monroe® Specialty™ Amortiguador		<b>58644</b>	(Pág. 46)	Volkswagen — Cabriolet	85-93 D
Cadillac — Escalade	07-14 T	Monroe® Load Adjusting Amortiguador		Volkswagen — Derby	93-98 D
Chevrolet — Avalanche	02-06 T	Chevrolet — Trailblazer	02-09 T	Volkswagen — Golf A2	85-91 D
Chevrolet — Suburban	00-06 T	<b>58645</b>	(Pág. 87)	Volkswagen — Golf A3	93-98 D
GMC — Yukon	01-06 T	Monroe® Load Adjusting Amortiguador		Volkswagen — Jetta A2	85-91 D
<b>40052</b>	(Pág. 31-32, 44-45)	Honda — Odyssey (Mini Van)	99-04 T	Volkswagen — Jetta A3	93-98 D
Monroe® Specialty™ Amortiguador		<b>58646</b>	(Pág. 92-93)	Volkswagen — Passat	93-97 D
Cadillac — Escalade	07-14 T	Monroe® Load Adjusting Amortiguador		<b>63619</b>	(Pág. 30-132)
Chevrolet — Avalanche	07-13 T	Jeep — Commander	06-10 T	Monroe® Strut-Mate® Kit Cubrepolvos	
Chevrolet — Suburban	07-14 T	Jeep — Grand Cherokee	05-10 T	Cadillac — Catera	97-01 D
<b>40056</b>	(Pág. 31)	<b>58647</b>	(Pág. 93)	Chevrolet — Cavalier	95-05 D
Monroe® Specialty™ Amortiguador		Monroe® Load Adjusting Amortiguador		Chevrolet — HHR	06-11 D
Cadillac — STS	05-09 T	Jeep — Grand Cherokee	99-04 T	Chevrolet — Malibu	04-12 D
<b>40201</b>	(Pág. 52, 55)	<b>58648</b>	(Pág. 51-52, 54, 62)	Chrysler — 300, 300C y 300M	99-04 D
Monroe® Specialty™ Amortiguador		Monroe® Load Adjusting Amortiguador		Chrysler — Concorde	93-04 D
Chrysler — Town & Country	01-05 T	Chrysler — Town & Country	08-16 T	Chrysler — LHS	94-01 D
Dodge — Caravan y Grand Caravan	01-07 T			Chrysler — PT Cruiser	01-10 D

Números de parte con P (P--) indican accesorios con la unidad



# PROGRESIVO AMORTIGUADORES

## INDICE PROGRESIVO DE APLICACIONES

Vehículo	Años Pos.	Vehículo	Años Pos.	Vehículo	Años Pos.
<b>63619 (Cont.)</b>	(Pág. 30-132)	<b>63620 (Cont.)</b>	(Pág. 34-132)	<b>63622 (Cont.)</b>	(Pág. 29-116)
Monroe® Strut-Mate® Kit Cubrepolvos		Monroe® Strut-Mate® Kit Cubrepolvos		Monroe® Strut-Mate® Kit Cubrepolvos	
Chrysler — Town & Country	01-07 D	Dodge — Caravan y Grand	95-00 D	Chevrolet — Lumina	89-96 D
Chrysler — Verna	00-06 D	Caravan		Chevrolet — Malibu	97-03 D
	00-06 T	Ford — Escort	83-90 T	Chevrolet — Monte Carlo	97-99 D
Chrysler — Voyager y Grand	01-07 D	Ford — Focus	00-05 D	Chevrolet — Uplander	05-09 D
Voyager		Ford — Ghia	84-94 D	Chevrolet — Venture (Mini Van)	97-05 D
Dodge — Caravan y Grand	01-07 D		84-94 T	AWD	
Caravan		Ford — Tempo	84-85 T	Chrysler — New Yorker y Fifth	84-87 D
Dodge — Intrepid	93-04 D	Ford — Thunderbird	87-88 D	Avenue	
Dodge — Neón	00-05 T	Ford — Topaz	85-94 D	Dodge — 600	84-88 D
	95-05 D		85-94 T	Dodge — Aries	84-89 D
Ford — Escort	97-03 T	Mercedes Benz — Van Sprinter	10-18 T	Dodge — Caravan y Grand	86-95 D
	83-03 D	Mercury — Cougar	87-88 D	Caravan	
Ford — Probe	89-92 D	Mercury — Topaz	85-94 D	Dodge — Daytona	84-88 D
	89-92 T		85-94 T	Dodge — Lancer	85-89 D
Ford — Tempo	84-85 D	Mercury — Zephyr	78-83 D	Infiniti — I30, I35	96-99 D
Infiniti — G20	91-96 T	Nissan — Altima	93-01 T	Nissan — Maxima	95-99 D
Lexus — ES330	04-06 D	Nissan — Datsun	79-84 D	Nissan — Stanza	87-89 T
	04-06 T		69-77 D	Oldsmobile — Calais	85-91 D
Mazda — 626 (Cronos)	83-87 D	Nissan — Maxima	89-94 D	Oldsmobile — Cutlass Ciera	82-96 D
	83-87 T	Nissan — Tsuru	92-17 T	Oldsmobile — Eighty-Eight (88)	91-99 D
Mercury — Sable	94-06 T	Toyota — Corolla	88-02 D		91-99 T
Mercury — Villager	93-02 D	Toyota — Tercel	95-99 D		87-89 T
Nissan — Altima	93-01 D			Oldsmobile — Eurosport	85-90 D
Nissan — Lucino	95-99 D	<b>63621</b>	(Pág. 29-116)	Oldsmobile — Intrigue	98-02 D
Nissan — Maxima	04-08 D	Monroe® Strut-Mate® Kit Cubrepolvos		Oldsmobile — Silhouette	90-05 D
	89-94 T	Buick — LaCrosse	10-15 D	Plymouth — Caravelle	84-88 D
Nissan — Quest (Mini Van)	93-03 D	Chevrolet — Beretta	92-94 D	Plymouth — Reliant	84-89 D
Nissan — Sentra	96-99 D	Chevrolet — Camaro	13-15 D	Plymouth — Sundance	87-88 D
Nissan — Tiida	07-18 D	Chevrolet — Corsica	92-96 D	Pontiac — Aztek AWD	01-05 D
Nissan — Tsubame	93-04 D	Chrysler — LeBaron	89-95 D	Pontiac — Bonneville	91-99 D
Nissan — Tsuru	88-91 T	Dodge — Daytona	89-93 D		91-99 T
	84-17 D	Dodge — Neón	95-99 T	Pontiac — Grand Am	99-05 D
Plymouth — Reliant	81-83 D	Ford — Mustang	85-04 D		85-91 D
Pontiac — G5	07-09 D	Ford — Taurus	86-94 D	Pontiac — Grand Prix	97-03 D
Pontiac — G6	05-10 D		86-94 T		
Pontiac — Grand Am	99-05 T	Ford — Thunderbird	89-97 D	<b>63628</b>	(Pág. 23-126)
Pontiac — Sunfire	95-05 D		80-86 D	Monroe® Strut-Mate® Kit Cubrepolvos	
Renault — Kangoo	07-09 D	Ford — Windstar (Mini Van)	94-03 D	Acura — Integra	94-01 D
Renault — Kangoo Express	04-12 D	Mercury — Cougar	89-97 D		94-01 T
Subaru — Legacy	00-04 D		83-86 D	Acura — TL	04-14 D
Toyota — Avalon	04-05 D	Mercury — Sable	94-06 D	Acura — TSX	09-14 D
	04-05 T	Nissan — Stanza	87-89 D		04-14 D
	95-96 D	Plymouth — Acclaim	89-95 D	Dodge — Stratus	99-06 T
	95-96 T	Plymouth — Sundance	89-94 D	Honda — Accord	13-17 T
Toyota — Camry	92-06 D	Pontiac — Grand Am	96-98 D		90-12 D
	92-06 T		92-94 D	Honda — Civic	92-00 D
Toyota — RAV4	96-00 D	<b>63622</b>	(Pág. 29-116)		92-00 T
Toyota — Solara	04-06 D	Monroe® Strut-Mate® Kit Cubrepolvos		Honda — Odyssey (Mini Van)	95-98 D
	04-06 T	Buick — Century	82-05 D	Hyundai — Azera	12-17 D
<b>63620</b>	(Pág. 34-132)	Cadillac — Cimarron	83-88 D	Infiniti — G20	99-02 D
Monroe® Strut-Mate® Kit Cubrepolvos		Chevrolet — Beretta	87-91 D		99-02 T
Chevrolet — Cavalier	92-94 D	Chevrolet — Cavalier	84-91 D	Infiniti — I30, I35	96-04 T
Chevrolet — Monte Carlo	97-99 T	Chevrolet — Celebrity	85-90 D	Jeep — Compass	07-17 T
Chrysler — Dynasty	88-93 D		82-83 D	Jeep — Patriot	07-17 T
Chrysler — New Yorker y Fifth	88-93 D	Chevrolet — Citation	82-84 D	Kia — Amanti	04-09 D
Avenue		Chevrolet — Corsica	87-91 D	Kia — Spectra	04-09 T
Chrysler — Town & Country	90-00 D	Chevrolet — Impala	00-13 D	Mazda — RX-8	04-08 D
Chrysler — Voyager y Grand	84-00 D		00-13 T		04-08 T
Voyager		Chevrolet — Impala Limited	14-16 D	Mitsubishi — Eclipse	00-05 T
			14-16 T	Mitsubishi — Lancer	02-11 T
				Mitsubishi — Outlander	03-13 T

Números de parte con P (P--) indican accesorios con la unidad



# PROGRESIVO AMORTIGUADORES

## INDICE PROGRESIVO DE APLICACIONES

Vehículo	Años Pos.	Vehículo	Años Pos.	Vehículo	Años Pos.
<b>63628 (Cont.)</b>	(Pág. 23-126)	<b>63631 (Cont.)</b>	(Pág. 24-136)	<b>63631 (Cont.)</b>	(Pág. 24-136)
Monroe® Strut-Mate® Kit Cubrepolvos		Monroe® Strut-Mate® Kit Cubrepolvos		Monroe® Strut-Mate® Kit Cubrepolvos	
Nissan — 350 Z	03-05 D	Chrysler — 200	11-14 D	Subaru — Outback	05-12 D
Nissan — Maxima	95-01 T	Chrysler — Cirrus	01-05 D	Suzuki — Aerio	02-07 D
Nissan — Sentra	96-06 T	Chrysler — Sebring	01-05 D	Toyota — Prius	16-17 DD
Toyota — Corolla	03-13 T	Chrysler — Town & Country	12-16 D		16-17 DI
<b>63629</b>	(Pág. 23, 49, 84, 108, 132)	Dodge — Caravan y Grand Caravan	12-16 D	Volkswagen — Beetle	98-11 D
Monroe® Strut-Mate® Kit Cubrepolvos		Dodge — Dart	13-16 D	Volkswagen — Bora	05-11 D
Acura — TL	04-05 T	Dodge — Journey	09-19 D	Volkswagen — Eos	07-16 D
Acura — TSX	04-08 T	Dodge — Ram Cargo Caravan (C/V)	12-15 D	Volkswagen — Golf A4	99-07 D
Chrysler — 200	11-14 T	Dodge — Sebring	01-05 D	Volkswagen — Jetta	11-18 D
Honda — Accord	03-12 T	Dodge — Stratus	01-05 D	Volkswagen — Jetta A4	99-10 D
Nissan — Maxima	02-03 T	Ford — C-Max	13-18 D	Volkswagen — Jetta Clasico	11-15 D
Toyota — Tercel	95-99 T	Ford — Edge	15-18 D	Volkswagen — Passat	2012 D
<b>63630</b>	(Pág. 33-135)	Ford — Escape	2019 D	Volkswagen — Passat CC	09-12 D
Monroe® Strut-Mate® Kit Cubrepolvos		Ford — Explorer	01-13 D	<b>63632</b>	(Pág. 35-134)
Chevrolet — Captiva	08-11 D	Ford — Fiesta	11-13 D	Monroe® Strut-Mate® Kit Cubrepolvos	
Chevrolet — Captiva Sport	12-15 D	Ford — Flex	13-19 D	BMW — 525i	01-03 T
Chevrolet — Equinox	08-17 D	Ford — Pickup Serie F-100, F-150, Lobo	09-13 D	BMW — 528i	95-00 T
Honda — CR-V	07-14 D	Ford — Transit	10-13 D	BMW — 540i	00-03 T
Honda — Fit	06-08 D	GMC — Acadia	07-16 D	Chevrolet — Cruze	10-12 D
Honda — Insight	10-14 D	Honda — Civic	01-15 D	Chrysler — Pacifica	04-08 D
Honda — Odyssey (Mini Van)	11-12 D	Honda — Civic	03-08 D	Dodge — Attitude	12-14 D
	05-07 D	Hyundai — Elantra	07-11 D	Dodge — Challenger	08-19 D
Honda — Pilot	09-15 D	Hyundai — Elantra	07-11 D	Ford — Focus	06-18 D
Hyundai — Santa Fe	13-18 D	Hyundai — Santa Fe	10-12 D	Hyundai — Elantra	11-17 D
	01-06 D	Hyundai — Tucson	10-15 D	Kia — Rio	12-15 D
Hyundai — Veracruz	07-12 D	Infiniti — I30, I35	00-04 D	Mazda — 3	04-13 D
Lexus — RX330	04-06 D	Jeep — Cherokee	14-18 D	Mazda — 5	12-15 D
Lexus — RX350	07-09 D	Jeep — Compass	07-17 D		06-10 D
Lexus — RX400H	06-07 D	Jeep — Patriot	11-17 D	Mini — Cooper	02-08 D
Mazda — CX-5	13-16 D	Kia — Forte	10-13 D	Saturn — Ion	03-06 D
Pontiac — Vibe	03-10 D	Kia — Optima	06-10 D	Toyota — Camry	12-17 T
Scion — tC	05-10 D	Kia — Rondo	07-11 D	Volkswagen — CC	09-17 D
Subaru — Forester	06-08 T	Kia — Sedona	02-05 D	<b>63633</b>	(Pág. 66, 85, 86, 106, 109, 138)
Subaru — Impreza	02-14 T	Kia — Spectra	04-09 D	Monroe® Strut-Mate® Kit Cubrepolvos	
Toyota — Avalon	05-15 D	Kia — Spectra 5	05-09 D	Ford — Explorer	11-12 D
Toyota — Camry	07-17 D	Lexus — RX330	04-06 T	Honda — Civic	02-05 D
Toyota — Corolla	09-13 D	Lexus — RX350	07-09 T	Honda — CR-V	02-06 D
Toyota — Highlander	04-19 D	Lexus — RX400H	06-07 T	Honda — Element	03-11 D
Toyota — Matrix	09-13 D	Lincoln — MKC	15-19 D	Nissan — Altima	02-06 D
Toyota — Prius	04-09 D	Lincoln — MKT	13-19 D	Nissan — Pathfinder	02-03 D
Toyota — Prius C	12-19 D	Lincoln — MKX	16-18 D	Volvo — C70	98-04 D
Toyota — RAV4	06-18 D	Mitsubishi — Eclipse	00-05 D	Volvo — S60	01-09 D
Toyota — Sienna	04-10 D	Mitsubishi — Galant	99-03 D	Volvo — V70	00-07 D
Toyota — Venza	09-12 D	Mitsubishi — Lancer	02-07 D	<b>63636</b>	(Pág. 24-136)
Toyota — Yaris	06-14 D	Nissan — Altima	07-18 D	Monroe® Strut-Mate® Kit Cubrepolvos	
Volkswagen — Beetle	12-18 D	Nissan — Maxima	16-18 D	Audi — A3	05-13 T
Volkswagen — Golf A2	85-91 D	Nissan — Murano	09-14 D	Chrysler — Cirrus	01-05 T
<b>63631</b>	(Pág. 24-136)	Nissan — Pathfinder	13-19 DD	Chrysler — Sebring	01-05 T
Monroe® Strut-Mate® Kit Cubrepolvos		Nissan — Sentra	00-19 D	Dodge — Sebring	01-05 T
Audi — A3	98-13 D	Subaru — Forester	06-13 D	Dodge — Stratus	01-05 T
BMW — 323i	07-10 D	Subaru — Impreza	02-14 D	Ford — Fiesta	11-19 T
BMW — 325i	01-05 D	Subaru — Legacy	05-14 D	Honda — Accord	90-97 T
BMW — 330i	01-05 D			Mazda — 3	04-13 T
BMW — 335i (E90, 92, 93)	07-13 D			Mazda — 5	12-15 T
Buick — Enclave	08-17 D				06-10 T
Buick — Regal	11-17 D			Mitsubishi — Galant	99-03 T
Buick — Verano	12-17 D			Volkswagen — Bora	05-11 T
Chevrolet — Cruze	12-15 D			Volkswagen — CC	09-17 T
Chevrolet — Traverse	09-17 D			Volkswagen — Eos	07-16 T

Números de parte con P (P--) indican accesorios con la unidad



## INDICE PROGRESIVO DE APLICACIONES

Vehículo	Años Pos.	Vehículo	Años Pos.	Vehículo	Años Pos.
<b>63636</b> (Cont.)	(Pág. 24-136)				
Monroe® Strut-Mate® Kit Cubrepolvos					
Volkswagen — Jetta	11-18 T				
Volkswagen — Jetta A4	99-10 T				
Volkswagen — Jetta Clasico	11-15 T				
Volkswagen — Passat	2012 T				
Volkswagen — Passat CC	09-12 T				
<b>63638</b>	(Pág. 23-129)				
Monroe® Strut-Mate® Kit Cubrepolvos					
BMW — 325i	95-97 D				
BMW — 525i	01-03 D				
BMW — 525iT	01-03 D				
BMW — 528i	95-03 D				
BMW — 528iT	95-00 D				
BMW — 530i	01-03 D				
BMW — 540i	95-03 D				
BMW — 540iT	00-03 D				
BMW — 740i, 740iL	94-01 D				
Ford — Edge	07-14 D				
Honda — Accord	13-17 D				
Honda — Civic	03-05 D				
Hyundai — Santa Fe	07-09 D				
Hyundai — Sonata	11-15 D				
Kia — Sedona	06-12 D				
Kia — Sorento	11-13 D				
Kia — Soul	10-19 D				
Lincoln — MKX	07-15 D				
Mazda — CX-7	07-12 D				
Mazda — CX-9	07-15 D				
Mitsubishi — Outlander	03-13 D				
Scion — iC	11-16 D				
Scion — xB	08-15 D				
Scion — xD	08-14 D				
Toyota — Prius	10-15 D				
Toyota — Prius V	12-16 D				
<b>63640</b>	(Pág. 85-137)				
Monroe® Strut-Mate® Kit Cubrepolvos					
Honda — CR-V	15-16 DD				
	15-16 DI				
Jeep — Patriot	07-10 D				
Mazda — 3	14-18 DD				
	14-18 DI				
Mazda — 6	14-17 DD				
	14-17 DI				
	09-13 D				
Nissan — Rogue	08-12 D				
Subaru — Crosstrek	16-17 D				
Subaru — Forester	14-17 D				
Subaru — Outback	13-14 D				
Subaru — Tribeca	08-14 D				
Subaru — XV Crosstrek	13-15 D				
Toyota — Corolla	14-18 D				
	03-08 D				
Toyota — Highlander	04-13 T				
Toyota — Sienna	11-14 D				
Toyota — Venza	09-12 T				
Volkswagen — Tiguan	09-17 D				
<b>65164</b>	(Pág. 61)				
Monroe® Gas-Magnum® 65 Amortiguador					
Dodge — Pickup Ram 4500	08-10 D				
Dodge — Pickup Ram 5500	08-10 D				
<b>65167</b>	(Pág. 75)				
Monroe® Gas-Magnum® 65 Amortiguador					
Ford — Pickup Serie F-450	07-19 D				
Ford — Pickup Serie F-550	07-16 D				
<b>65168</b>	(Pág. 75)				
Monroe® Gas-Magnum® 65 Amortiguador					
Ford — Pickup Serie F-450	07-15 T				
Ford — Pickup Serie F-550	07-16 T				
<b>65174</b>	(Pág. 75)				
Monroe® Gas-Magnum® 65 Amortiguador					
Ford — Pickup Serie F-450	07-16 T				
<b>65181</b>	(Pág. 61)				
Monroe® Gas-Magnum® 65 Amortiguador					
Dodge — Pickup Ram 4500	09-10 T				
Dodge — Pickup Ram 5500	09-10 T				
<b>65183</b>	(Pág. 76)				
Monroe® Magnum™ Amortiguador					
Ford — Pickup F650 y F750	16-17 D				
<b>65185</b>	(Pág. 76)				
Monroe® Magnum™ Amortiguador					
Ford — Pickup F650 y F750	15-17 T				
<b>66414</b>	(Pág. 63, 102)				
Monroe® Gas-Magnum® 60 Amortiguador					
Dodge — Van Sprinter	07-09 T				
Mercedes Benz — Van Sprinter	10-18 T				
<b>66415</b>	(Pág. 63)				
Monroe® Gas-Magnum® 60 Amortiguador					
Dodge — Van Sprinter	03-09 T				
<b>66417</b>	(Pág. 63)				
Monroe® Gas-Magnum® 60 Amortiguador					
Dodge — Van Sprinter	03-06 T				
<b>66439</b>	(Pág. 77)				
Monroe® Gas-Magnum® 60 Amortiguador					
Ford — Transit	15-19 T				
<b>66440</b>	(Pág. 117)				
Monroe® Gas-Magnum® 60 Amortiguador					
RAM — Serie Promaster	14-19 T				
<b>66450</b>	(Pág. 102)				
Monroe® Gas-Magnum® 60 Amortiguador					
Mercedes Benz — Van Sprinter	10-18 T				
<b>66451</b>	(Pág. 77)				
Monroe® Gas-Magnum® 60 Amortiguador					
Ford — Transit	15-16 T				
<b>66453</b>	(Pág. 102)				
Monroe® Gas-Magnum® 60 Amortiguador					
Mercedes Benz — Van Sprinter	17-18 T				
<b>71026</b>	(Pág. 35, 38)				
Monroe® OESpectrum® Strut					
Chevrolet — Corsa	01-08 DD				
Chevrolet — Meriva	03-08 DD				
<b>71027</b>	(Pág. 35, 38)				
Monroe® OESpectrum® Strut					
Chevrolet — Corsa	01-08 DI				
Chevrolet — Meriva	03-08 DI				
<b>71029</b>	(Pág. 119, 136)				
Monroe® OESpectrum® Strut					
Seat — Cordoba	03-09 D				
Seat — Ibiza	03-09 D				
Volkswagen — Lupo	03-09 D				
Volkswagen — Polo	03-08 D				
<b>71030</b>	(Pág. 105)				
Monroe® OESpectrum® Strut					
Nissan — Almera	01-06 DD				
<b>71031</b>	(Pág. 105)				
Monroe® OESpectrum® Strut					
Nissan — Almera	01-06 DI				
<b>71032</b>	(Pág. 105)				
Monroe® OESpectrum® Strut					
Nissan — Almera	01-06 TD				
	01-06 TI				
<b>71033</b>	(Pág. 119, 137)				
Monroe® OESpectrum® Strut					
Seat — Alhambra	02-08 D				
Volkswagen — Sharan	02-08 D				
<b>71038</b>	(Pág. 118)				
Monroe® OESpectrum® Strut					
Renault — Laguna	03-06 D				
<b>71039</b>	(Pág. 118)				
Monroe® OESpectrum® Strut					
Renault — Kangoo	07-09 D				
Renault — Kangoo Express	04-12 D				
<b>71040</b>	(Pág. 63, 117)				
Monroe® OESpectrum® Strut					
Fiat — Palio	03-11 DD				
	03-11 DI				
Fiat — Strada	07-16 D				
<b>71041</b>	(Pág. 127)				
Monroe® OESpectrum® Strut					
Toyota — Hilux	04-15 D				
<b>71042</b>	(Pág. 114)				
Monroe® OESpectrum® Strut					
Peugeot — Partner	03-09 D				
<b>71048</b>	(Pág. 137)				
Monroe® OESpectrum® Strut					
Volkswagen — SportVan	06-07 D				
<b>71053</b>	(Pág. 118)				
Monroe® OESpectrum® Strut					
Renault — Kangoo Express	13-18 D				
<b>71054</b>	(Pág. 133)				
Monroe® OESpectrum® Strut					
Volkswagen — Amarok	10-18 D				
<b>71056</b>	(Pág. 64)				
Monroe® OESpectrum® Strut					
Ford — EcoSport	06-12 DD				
<b>71058</b>	(Pág. 24, 119-120, 136-137)				
Monroe® OESpectrum® Strut					
Seat — Ibiza	10-17 D				
Seat — Nuevo Ibiza	01-02 D				
Seat — Toledo	13-19 D				
Volkswagen — Vento	13-17 D				



# PROGRESIVO AMORTIGUADORES

## INDICE PROGRESIVO DE APLICACIONES

Vehículo	Años Pos.	Vehículo	Años Pos.	Vehículo	Años Pos.
<b>71059</b>	(Pág. 107-108, 112)	<b>71124</b>	(Pág. 66-67)	<b>71141</b>	(Pág. 72)
Monroe® OESpectrum® Strut		Monroe® Reflex® Strut		Monroe® Reflex® Strut	
Nissan — Note	14-19 DD	Ford — Explorer	06-10 D	Ford — Pickup Serie F-100, F-150, Lobo	09-13 D
Nissan — Versa	12-13 DD	<b>71125</b>	(Pág. 66-67)	<b>71143</b>	(Pág. 90)
<b>71060</b>	(Pág. 107-108, 112)	Monroe® Reflex® Strut		Monroe® OESpectrum® Strut	
Monroe® OESpectrum® Strut		Ford — Explorer	06-10 T	Infiniti — G35	04-06 DI
Nissan — Note	14-19 DI	<b>71126</b>	(Pág. 49, 51, 53)	<b>71144</b>	(Pág. 90)
Nissan — Versa	12-13 DI	Monroe® OESpectrum® Strut		Monroe® OESpectrum® Strut	
<b>71061</b>	(Pág. 57)	Chrysler — 200	11-14 TD	Infiniti — G35	04-06 DD
Monroe® OESpectrum® Strut			11-14 TI	<b>71147</b>	(Pág. 105)
Dodge — i10	12-14 DD	Chrysler — Cirrus	07-10 TD	Monroe® OESpectrum® Strut	
<b>71062</b>	(Pág. 57)		07-10 TI	Mitsubishi — Outlander	05-06 T
Monroe® OESpectrum® Strut		Chrysler — Sebring	07-10 TD	<b>71265</b>	(Pág. 134-136)
Dodge — i10	12-14 DI		07-10 TI	Monroe® OESpectrum® Strut	
<b>71063</b>	(Pág. 108)	Dodge — Avenger	07-14 TD	Volkswagen — Cabrio	95-02 T
Monroe® OESpectrum® Strut			07-14 TI	Volkswagen — Golf A2	85-91 T
Nissan — Micra	04-08 DD	<b>71128</b>	(Pág. 51-52, 54, 137)	Volkswagen — Golf A3	93-98 T
<b>71100</b>	(Pág. 56)	Monroe® OESpectrum® Strut		Volkswagen — Jetta A2	85-91 T
Monroe® Reflex® Strut		Chrysler — Town & Country	08-16 D	Volkswagen — Jetta A3	93-98 T
Dodge — Dakota	05-08 D	Chrysler — Voyager y Grand Voyager	12-16 D	<b>71276</b>	(Pág. 104)
<b>71102</b>	(Pág. 107, 109)	Dodge — Caravan y Grand Caravan	08-11 D	Monroe® OESpectrum® Strut	
Monroe® OESpectrum® Strut		Volkswagen — Routan	09-12 D	Mitsubishi — Eclipse	00-05 TD
Nissan — Frontier Pickup	05-19 D	<b>71130</b>	(Pág. 49, 51, 53)		00-05 TI
<b>71103</b>	(Pág. 109, 112)	Monroe® OESpectrum® Strut		<b>71278</b>	(Pág. 107, 111)
Monroe® OESpectrum® Strut		Chrysler — 200	11-14 DD	Monroe® OESpectrum® Strut	
Nissan — Pathfinder	05-12 D	Chrysler — Cirrus	07-10 DD	Nissan — Lucino	95-99 TD
Nissan — Xterra	05-15 D	Chrysler — Sebring	07-10 DD		95-99 TI
<b>71105</b>	(Pág. 132)	Dodge — Avenger	07-14 DD	Nissan — Sentra	96-99 TD
Monroe® OESpectrum® Strut		<b>71131</b>	(Pág. 49, 51, 53)		96-99 TI
Toyota — Tacoma	05-15 DD	Monroe® OESpectrum® Strut		<b>71281</b>	(Pág. 34, 116)
<b>71106</b>	(Pág. 132)	Chrysler — 200	11-14 DI	Monroe® OESpectrum® Strut	
Monroe® OESpectrum® Strut		Chrysler — Cirrus	07-10 DI	Chevrolet — Cavalier	95-05 T
Toyota — Tacoma	05-15 DI	Chrysler — Sebring	07-10 DI	Pontiac — Sunfire	95-05 T
<b>71110</b>	(Pág. 95-96)	Dodge — Avenger	07-14 DI	<b>71292</b>	(Pág. 85)
Monroe® OESpectrum® Strut		<b>71135</b>	(Pág. 94-95)	Monroe® OESpectrum® Strut	
Kia — Sorento	03-09 DI	Monroe® OESpectrum® Strut		Honda — Civic	96-00 T
<b>71111</b>	(Pág. 59)	Kia — Magentis	06-10 DD	<b>71293</b>	(Pág. 91, 108)
Monroe® Reflex® Strut		Kia — Optima	06-10 DD	Monroe® OESpectrum® Strut	
Dodge — Pickup Ram 1500	06-08 D	Kia — Rondo	07-11 DD	Infiniti — I30, I35	96-99 T
<b>71112</b>	(Pág. 103)	<b>71136</b>	(Pág. 94-95)	Nissan — Maxima	95-99 TD
Monroe® OESpectrum® Strut		Monroe® OESpectrum® Strut			95-99 TI
Mini — Cooper	02-08 TD	Kia — Magentis	06-10 DI	<b>71297</b>	(Pág. 132)
	02-08 TI	Kia — Optima	06-10 DI	Monroe® OESpectrum® Strut	
<b>71116</b>	(Pág. 90)	Kia — Rondo	07-11 DI	Toyota — Tercel	95-99 TD
Monroe® OESpectrum® Strut		<b>71138</b>	(Pág. 66, 98)		95-99 TI
Infiniti — G35	03-07 DD	Monroe® Reflex® Strut		<b>71304</b>	(Pág. 136)
<b>71117</b>	(Pág. 90)	Ford — Expedition	07-13 D	Monroe® OESpectrum® Strut	
Monroe® OESpectrum® Strut		Lincoln — Navigator	07-13 D	Volkswagen — Passat	98-00 D
Infiniti — G35	03-07 DI	<b>71139</b>	(Pág. 66, 98)	<b>71311</b>	(Pág. 49-51, 63)
<b>71122</b>	(Pág. 101)	Monroe® Reflex® Strut		Monroe® OESpectrum® Strut	
Monroe® OESpectrum® Strut		Ford — Expedition	07-17 T	Chrysler — Cirrus	99-06 T
Mazda — RX-8	04-08 D	Lincoln — Navigator	07-17 T	Chrysler — Sebring	01-06 T
<b>71123</b>	(Pág. 101)	<b>71140</b>	(Pág. 71)	Dodge — Stratus	99-06 T
Monroe® OESpectrum® Strut		Monroe® Reflex® Strut		<b>71312</b>	(Pág. 110-111, 119)
Mazda — RX-8	04-08 T	Ford — Pickup Serie F-100, F-150, Lobo	09-13 D	Monroe® OESpectrum® Strut	
				Nissan — Sentra	00-06 TD
					00-06 TI

Números de parte con P (P--) indican accesorios con la unidad



# PROGRESIVO AMORTIGUADORES

## INDICE PROGRESIVO DE APLICACIONES

Vehículo	Años Pos.	Vehículo	Años Pos.	Vehículo	Años Pos.
<b>71312</b> (Cont.)	(Pág. 110-111, 119)	<b>71346</b>	(Pág. 64, 70, 99)	<b>71368</b>	(Pág. 77, 97)
Monroe® OESpectrum® Strut		Monroe® OESpectrum® Strut		Monroe® OESpectrum® Strut	
Renault — Scala	11-13 TD	Ford — Crown Victoria	03-11 D	Ford — Thunderbird	02-05 D
	11-13 TI	Ford — Grand Marquis	03-11 D	Lincoln — LS	03-06 D
<b>71313</b>	(Pág. 50-51, 62, 104)	Lincoln — Town Car	03-11 D	<b>71371</b>	(Pág. 123, 126, 132)
Monroe® OESpectrum® Strut		<b>71347</b>	(Pág. 132-133)	Monroe® OESpectrum® Strut	
Chrysler — Cirrus	01-05 TD	Monroe® OESpectrum® Strut		Toyota — FJ Cruiser	07-13 D
	01-05 TI	Toyota — Tundra	00-06 D	Toyota — Tacoma	05-15 D
Chrysler — Sebring	01-05 TD	<b>71349</b>	(Pág. 26-28)	<b>71373</b>	(Pág. 117, 126, 128)
	01-05 TI	Monroe® OESpectrum® Strut		Monroe® OESpectrum® Strut	
Dodge — Sebring	01-05 TD	BMW — 525i	01-03 TD	Pontiac — Vibe	03-08 TD
	01-05 TI		01-03 TI		03-08 TI
Dodge — Stratus	01-05 TD	BMW — 528i	95-03 TD	Toyota — Corolla	03-08 TD
	01-05 TI		95-03 TI		03-08 TI
Mitsubishi — Galant	99-03 TD	BMW — 530i	01-03 TD	Toyota — Matrix	03-08 TD
	99-03 TI		01-03 TI		03-08 TI
<b>71321</b>	(Pág. 66)	BMW — 540i	95-03 T	<b>71377</b>	(Pág. 92-93)
Monroe® Reflex® Strut		<b>71351</b>	(Pág. 123, 132)	Monroe® Reflex® Strut	
Ford — Explorer	02-03 D	Monroe® OESpectrum® Strut		Jeep — Commander	06-10 D
<b>71322</b>	(Pág. 66)	Toyota — 4 Runner	96-02 D	Jeep — Grand Cherokee	05-10 D
Monroe® Reflex® Strut		Toyota — Tacoma	95-04 DD	<b>71379</b>	(Pág. 104-105)
Ford — Explorer	02-05 T		95-04 DI	Monroe® OESpectrum® Strut	
<b>71327</b>	(Pág. 91, 108)	<b>71352</b>	(Pág. 123, 132)	Mitsubishi — Lancer	02-07 T
Monroe® OESpectrum® Strut		Monroe® OESpectrum® Strut		<b>71380</b>	(Pág. 86)
Infiniti — I30, I35	02-04 TD	Toyota — 4 Runner	96-02 D	Monroe® OESpectrum® Strut	
	02-04 TI	Toyota — Tacoma	95-04 DD	Honda — CR-V	02-06 TD
	00-01 T		95-04 DI		02-06 TI
Nissan — Maxima	00-03 TD	<b>71353</b>	(Pág. 35, 79)	<b>71391</b>	(Pág. 92)
	00-03 TI	Monroe® Reflex® Strut		Monroe® OESpectrum® Strut	
<b>71331</b>	(Pág. 24)	Chevrolet — Colorado Pickup	04-12 D	Jaguar — X	02-08 D
Monroe® OESpectrum® Strut		GMC — Canyon Pickup	04-12 D	<b>71400</b>	(Pág. 52)
Audi — A4	97-16 D	<b>71354</b>	(Pág. 122)	Monroe® OESpectrum® Strut	
<b>71332</b>	(Pág. 24)	Monroe® OESpectrum® Strut		Chrysler — Verna	00-06 DD
Monroe® OESpectrum® Strut		Subaru — Legacy	00-04 T	<b>71419</b>	(Pág. 108)
Audi — A4	97-16 T	<b>71357</b>	(Pág. 105)	Monroe® OESpectrum® Strut	
<b>71334</b>	(Pág. 24, 136)	Monroe® OESpectrum® Strut		Nissan — Maxima	00-01 DI
Monroe® OESpectrum® Strut		Mitsubishi — Montero	01-03 D	<b>71426</b>	(Pág. 106)
Audi — A6	99-04 T	<b>71358</b>	(Pág. 106, 111)	Monroe® OESpectrum® Strut	
Volkswagen — Passat	98-05 T	Monroe® OESpectrum® Strut		Nissan — Altima	02-06 DD
<b>71335</b>	(Pág. 24, 136)	Nissan — Armada	05-15 D	<b>71427</b>	(Pág. 106)
Monroe® OESpectrum® Strut		Nissan — Titan Pickup	04-15 D	Monroe® OESpectrum® Strut	
Audi — A6	00-04 D	<b>71359</b>	(Pág. 111)	Nissan — Altima	02-06 DI
Volkswagen — Passat	01-05 D	Monroe® OESpectrum® Strut		<b>71435</b>	(Pág. 89)
<b>71340</b>	(Pág. 85)	Nissan — Sentra	02-06 TD	Monroe® OESpectrum® Strut	
Monroe® OESpectrum® Strut			02-06 TI	Hyundai — Santa Fe	01-06 DD
Honda — Civic	01-05 TD	<b>71361</b>	(Pág. 72, 99)	<b>71436</b>	(Pág. 89)
	01-05 TI	Monroe® Reflex® Strut		Monroe® OESpectrum® Strut	
<b>71341</b>	(Pág. 46, 79)	Ford — Pickup Serie F-100, F-150, Lobo	04-08 D	Hyundai — Santa Fe	01-06 DI
Monroe® OESpectrum® Strut		Lincoln — Pickup Mark LT	06-08 D	<b>71453</b>	(Pág. 130)
Chevrolet — Trailblazer	02-09 D	<b>71362</b>	(Pág. 71, 98)	Monroe® OESpectrum® Strut	
GMC — Envoy	02-09 D	Monroe® Reflex® Strut		Toyota — RAV4	00-05 DD
<b>71344</b>	(Pág. 97)	Ford — Pickup Serie F-100, F-150, Lobo	04-08 D	<b>71454</b>	(Pág. 130)
Monroe® OESpectrum® Strut		Lincoln — Pickup Mark LT	06-08 D	Monroe® OESpectrum® Strut	
Lincoln — LS	00-02 D	<b>71366</b>	(Pág. 92)	Toyota — RAV4	00-05 DI
<b>71345</b>	(Pág. 77, 97)	Monroe® OESpectrum® Strut		<b>71455</b>	(Pág. 26-27)
Monroe® OESpectrum® Strut		Jaguar — S	00-02 D	Monroe® OESpectrum® Strut	
Ford — Thunderbird	02-05 T			BMW — 525i	01-03 DD
Lincoln — LS	00-06 T				

Números de parte con P (P--) indican accesorios con la unidad



# PROGRESIVO AMORTIGUADORES

## INDICE PROGRESIVO DE APLICACIONES

Vehículo	Años Pos.	Vehículo	Años Pos.	Vehículo	Años Pos.
<b>71455 (Cont.)</b>	(Pág. 26-27)	<b>71525 (Cont.)</b>	(Pág. 24, 119-120, 133, 135-136)	<b>71592</b>	(Pág. 51)
Monroe® OESpectrum® Strut		Monroe® OESpectrum® Strut		Monroe® OESpectrum® Strut	
BMW — 525iT	01-03 DD	Volkswagen — Beetle	98-11 D	Chrysler — PT Cruiser	01-10 D
BMW — 528i	95-03 DD	Volkswagen — Golf A4	99-07 D	<b>71593</b>	(Pág. 65, 102)
BMW — 528iT	95-00 DD	Volkswagen — Jetta A4	99-10 D	Monroe® OESpectrum® Strut	
BMW — 530i	01-03 DD	Volkswagen — Jetta Clasico	11-15 D	Ford — Escape	01-12 DD
<b>71456</b>	(Pág. 26-27)	<b>71565</b>	(Pág. 49-51, 63)	Mercury — Mariner	05-11 DD
Monroe® OESpectrum® Strut		Monroe® OESpectrum® Strut		<b>71594</b>	(Pág. 65, 102)
BMW — 525i	01-03 DI	Chrysler — Cirrus	99-06 D	Monroe® OESpectrum® Strut	
BMW — 525iT	01-03 DI	Chrysler — Sebring	01-06 D	Ford — Escape	01-12 DI
BMW — 528i	95-03 DI	Dodge — Stratus	99-06 D	Mercury — Mariner	05-11 DI
BMW — 528iT	95-00 DI	<b>71566</b>	(Pág. 111)	<b>71597</b>	(Pág. 87)
BMW — 530i	01-03 DI	Monroe® OESpectrum® Strut		Monroe® OESpectrum® Strut	
<b>71461</b>	(Pág. 91, 108)	Nissan — Sentra	00-01 DD	Honda — Odyssey (Mini Van)	99-04 DD
Monroe® OESpectrum® Strut		<b>71567</b>	(Pág. 111)	<b>71598</b>	(Pág. 87)
Infiniti — I30, I35	02-04 DD	Monroe® OESpectrum® Strut		Monroe® OESpectrum® Strut	
Nissan — Maxima	02-03 DD	Nissan — Sentra	00-01 DI	Honda — Odyssey (Mini Van)	99-04 DI
<b>71462</b>	(Pág. 91, 108)	<b>71571</b>	(Pág. 109)	<b>71615</b>	(Pág. 103)
Monroe® OESpectrum® Strut		Monroe® OESpectrum® Strut		Monroe® OESpectrum® Strut	
Infiniti — I30, I35	02-04 DI	Nissan — Pathfinder	96-98 DI	Mercury — Sable	96-06 D
Nissan — Maxima	02-03 DI	<b>71572</b>	(Pág. 52, 54-55)	<b>71654</b>	(Pág. 132)
<b>71483</b>	(Pág. 138)	Monroe® OESpectrum® Strut		Monroe® OESpectrum® Strut	
Monroe® OESpectrum® Strut		Chrysler — Town & Country	01-07 D	Toyota — Tercel	95-99 DD
Volvo — S40	00-04 DD	Chrysler — Voyager y Grand Voyager	01-07 D	<b>71655</b>	(Pág. 132)
Volvo — V40	00-04 DD	Dodge — Caravan y Grand Caravan	01-07 D	Monroe® OESpectrum® Strut	
<b>71484</b>	(Pág. 138)	<b>71573</b>	(Pág. 109)	Toyota — Tercel	95-99 DI
Monroe® OESpectrum® Strut		Monroe® OESpectrum® Strut		<b>71661</b>	(Pág. 29, 36-37, 48, 114, 116)
Volvo — S40	00-04 DI	Nissan — Pathfinder	98-01 DD	Monroe® OESpectrum® Strut	
Volvo — V40	00-04 DI	<b>71575</b>	(Pág. 133)	Buick — Century	97-05 DD
<b>71485</b>	(Pág. 138)	Monroe® OESpectrum® Strut		97-05 DI	
Monroe® OESpectrum® Strut		Toyota — Yaris	04-05 D	Chevrolet — Impala	00-13 DD
Volvo — S60	01-09 D	<b>71577</b>	(Pág. 58, 93)	00-13 DI	
Volvo — S80	99-06 D	Monroe® OESpectrum® Strut		Chevrolet — Venture (Mini Van) AWD	97-05 D
Volvo — V70	00-07 D	Dodge — Nitro	07-12 DD	Oldsmobile — Silhouette	97-05 D
<b>71486</b>	(Pág. 101)	07-12 DI		Pontiac — Grand Prix	97-03 D
Monroe® OESpectrum® Strut		Jeep — Liberty	02-12 DD	<b>71662</b>	(Pág. 29, 37, 116)
Mercedes Benz — Clase C	00-07 D	02-12 DI		Monroe® OESpectrum® Strut	
<b>71488</b>	(Pág. 101)	<b>71580</b>	(Pág. 58)	Buick — Century	97-05 TD
Monroe® OESpectrum® Strut		Monroe® OESpectrum® Strut		97-05 TI	
Mercedes Benz — Clase C	00-07 D	Dodge — Neón	00-05 D	Chevrolet — Impala	00-09 TD
<b>71493</b>	(Pág. 125)	<b>71581</b>	(Pág. 25-26)	00-09 TI	
Monroe® OESpectrum® Strut		Monroe® OESpectrum® Strut		Pontiac — Grand Prix	97-03 T
Toyota — Camry	02-03 TI	BMW — 323i	99-00 DD	<b>71663</b>	(Pág. 37, 38)
<b>71503</b>	(Pág. 30)	BMW — 325i	01-05 DD	Monroe® OESpectrum® Strut	
Monroe® OESpectrum® Strut		BMW — 330i	01-05 DD	Chevrolet — Lumina	97-01 TD
Cadillac — Catera	97-01 D	<b>71584</b>	(Pág. 52)	97-01 TI	
<b>71504</b>	(Pág. 69)	Monroe® OESpectrum® Strut		Chevrolet — Monte Carlo	97-99 TD
Monroe® OESpectrum® Strut		Chrysler — Verna	00-06 TD	97-99 TI	
Ford — Focus	00-05 DD	<b>71590</b>	(Pág. 46)	<b>71667</b>	(Pág. 49-50, 57)
<b>71505</b>	(Pág. 69)	Monroe® OESpectrum® Strut		Monroe® OESpectrum® Strut	
Monroe® OESpectrum® Strut		Chrysler — 300, 300C y 300M	99-04 DD	Chrysler — Concorde	98-04 DD
Ford — Focus	00-05 DI	Chrysler — LHS	98-01 DD	Chrysler — LHS	98-01 DD
<b>71525</b>	(Pág. 24, 119-120, 133, 135-136)	Dodge — Intrepid	98-04 DD	Dodge — Intrepid	98-04 DD
Monroe® OESpectrum® Strut		<b>71591</b>	(Pág. 46)	<b>71668</b>	(Pág. 49-50, 57)
Audi — A3	98-04 D	Monroe® OESpectrum® Strut		Monroe® OESpectrum® Strut	
Seat — León	01-08 D	Chevrolet — Tracker	98-08 DD	Chrysler — 300, 300C y 300M	99-04 DI
Seat — Toledo	01-08 D	<b>71592</b>	(Pág. 46)		
		Chevrolet — Tracker	98-08 DI		

Números de parte con P (P--) indican accesorios con la unidad



# PROGRESIVO AMORTIGUADORES

## INDICE PROGRESIVO DE APLICACIONES

Vehículo	Años Pos.	Vehículo	Años Pos.	Vehículo	Años Pos.
<b>71668 (Cont.)</b>	(Pág. 49-50, 57)	<b>71687 (Cont.)</b>	(Pág. 64, 70, 102)	<b>71933 (Cont.)</b>	(Pág. 135-136)
Monroe® OESpectrum® Strut		Monroe® OESpectrum® Strut		Monroe® OESpectrum® Strut	
Chrysler — Concorde	98-04 DI	Ford — Mystique	97-00 D	Volkswagen — Jetta A3	93-98 D
Chrysler — LHS	98-01 DI	Mercury — Cougar	99-02 D		(Pág. 106)
Dodge — Intrepid	98-04 DI	<b>71691</b>	(Pág. 84)	Monroe® OESpectrum® Strut	
<b>71669</b>	(Pág. 49-50, 57)	Monroe® OESpectrum® Strut		Nissan — Altima	93-99 ID
Monroe® OESpectrum® Strut		Honda — Accord	98-02 D		(Pág. 106)
Chrysler — 300, 300C y 300M	99-04 TD	<b>71699</b>	(Pág. 138)	Monroe® OESpectrum® Strut	
	99-04 TI	Monroe® OESpectrum® Strut		Nissan — Altima	93-99 TI
Chrysler — Concorde	98-04 TD	Volvo — C70	98-04 D		(Pág. 126)
	98-04 TI	<b>71716</b>	(Pág. 77, 102)	Monroe® OESpectrum® Strut	
Chrysler — LHS	98-01 TD	Monroe® OESpectrum® Strut		Toyota — Corolla	93-02 DD
	98-01 TI	Ford — Thunderbird	80-86 D		(P808)
Dodge — Intrepid	98-04 TD	Mercury — Cougar	83-86 D	<b>71952</b>	
	98-04 TI	<b>71728</b>	(Pág. 33)	Monroe® OESpectrum® Strut	
<b>71671</b>	(Pág. 37, 113)	Monroe® OESpectrum® Strut		Toyota — Corolla	93-02 DI
Monroe® OESpectrum® Strut		Chevrolet — Camaro	82-92 D		(Pág. 126)
Chevrolet — Impala	00-05 TD	<b>71828</b>	(Pág. 67, 71, 77, 102-103)	Monroe® OESpectrum® Strut	
	00-05 TI	Monroe® OESpectrum® Strut		Toyota — Corolla	93-02 ID
Oldsmobile — Intrigue	98-02 TD	Ford — Fairline y Fairline 500	78-83 D		(P808)
	98-02 TI	Ford — Mustang	85-93 D	Monroe® OESpectrum® Strut	
<b>71674</b>	(Pág. 106)	Ford — Thunderbird	87-88 D	Toyota — Corolla	93-02 TI
Monroe® OESpectrum® Strut		Mercury — Capri y Capri II	79-86 D		(Pág. 71)
Nissan — Altima	00-01 DD	Mercury — Cougar	87-88 D	Monroe® OESpectrum® Strut	
<b>71675</b>	(Pág. 106)	Mercury — Zephyr	78-83 D	Ford — Mustang	94-04 D
Monroe® OESpectrum® Strut		<b>71829</b>	(Pág. 84)		(Pág. 70-71)
Nissan — Altima	00-01 DI	Monroe® OESpectrum® Strut		<b>71963</b>	
<b>71676</b>	(Pág. 106)	Honda — Accord	86-89 D	Monroe® OESpectrum® Strut	
Monroe® OESpectrum® Strut		<b>71846</b>	(Pág. 126)	Ford — Mustang	94-04 D
Nissan — Altima	00-01 TD	Monroe® OESpectrum® Strut			(Pág. 52, 55)
<b>71677</b>	(Pág. 106)	Toyota — Corolla	88-92 TD	Monroe® OESpectrum® Strut	
Monroe® OESpectrum® Strut		<b>71847</b>	(Pág. 126)	Chrysler — Town & Country	95-00 D
Nissan — Altima	00-01 TI	Monroe® OESpectrum® Strut		Chrysler — Voyager y Grand Voyager	95-00 D
<b>71678</b>	(Pág. 125)	Toyota — Corolla	88-92 TI	Dodge — Caravan y Grand Caravan	95-00 D
Monroe® OESpectrum® Strut		<b>71853</b>	(Pág. 135-136)		(Pág. 107, 111)
Toyota — Camry	97-01 DD	Monroe® OESpectrum® Strut		Monroe® OESpectrum® Strut	
<b>71680</b>	(Pág. 124-125)	Volkswagen — Golf A2	85-91 D	Nissan — Lucino	95-99 DD
Monroe® OESpectrum® Strut		Volkswagen — Jetta A2	85-91 D	Nissan — Sentra	96-99 DD
Toyota — Avalon	95-96 TD	<b>71897</b>	(Pág. 50-51, 63)		(Pág. 107, 111)
Toyota — Camry	92-01 TD	Monroe® OESpectrum® Strut		<b>71969</b>	
<b>71681</b>	(Pág. 124-125)	Chrysler — Cirrus	96-98 D	Monroe® OESpectrum® Strut	
Monroe® OESpectrum® Strut		Chrysler — Stratus	95-97 D	Nissan — Lucino	95-99 DI
Toyota — Avalon	95-96 TI	Dodge — Stratus	95-98 D	Nissan — Sentra	96-99 DI
Toyota — Camry	92-01 TI	<b>71900</b>	(Pág. 103, 110)		(Pág. 37)
<b>71682</b>	(Pág. 108)	Monroe® OESpectrum® Strut		Monroe® OESpectrum® Strut	
Monroe® OESpectrum® Strut		Mercury — Villager	93-98 DD	Chevrolet — Lumina	95-96 I
Nissan — Maxima	95-99 DD	Nissan — Quest (Mini Van)	93-98 DD		(Pág. 64, 70, 102)
<b>71683</b>	(Pág. 108)	<b>71901</b>	(Pág. 103, 110)	<b>71984</b>	
Monroe® OESpectrum® Strut		Monroe® OESpectrum® Strut		Monroe® OESpectrum® Strut	
Nissan — Maxima	95-99 DI	Mercury — Villager	93-98 DI	Ford — Contour	95-00 T
<b>71686</b>	(Pág. 38, 116)	Nissan — Quest (Mini Van)	93-98 DI	Ford — Mystique	97-00 T
Monroe® OESpectrum® Strut		<b>71920</b>	(Pág. 78)	Mercury — Cougar	99-02 T
Chevrolet — Malibu	99-03 T	Monroe® OESpectrum® Strut		Mercury — Mystique	95-97 T
Pontiac — Grand Am	99-05 T	Ford — Windstar (Mini Van)	94-03 D		(Pág. 110)
<b>71687</b>	(Pág. 64, 70, 102)	<b>71933</b>	(Pág. 135-136)	<b>72105</b>	
Monroe® OESpectrum® Strut		Monroe® OESpectrum® Strut		Monroe® OESpectrum® Strut	
Ford — Contour	97-00 D	Volkswagen — Golf A3	93-98 D	Nissan — Sentra	02-06 DD
					(Pág. 110)
				Monroe® OESpectrum® Strut	
				Nissan — Sentra	02-06 DI

Números de parte con P (P-) indican accesorios con la unidad





# PROGRESIVO AMORTIGUADORES

## INDICE PROGRESIVO DE APLICACIONES

Vehículo	Años Pos.	Vehículo	Años Pos.	Vehículo	Años Pos.
<b>72107</b>	(Pág. 111, 119)	<b>72178</b>	(Pág. 119)	<b>72213</b>	(Pág. 127)
Monroe® OESpectrum® Strut		Monroe® OESpectrum® Strut		Monroe® OESpectrum® Strut	
Nissan — Sentra	02-06 DD	Saab — 9-5	02-06 D	Toyota — Highlander	04-07 TD
Renault — Scala	11-13 DD	<b>72179</b>	(Pág. 36, 115)	<b>72214</b>	(Pág. 127)
<b>72108</b>	(Pág. 111, 119)	Monroe® OESpectrum® Strut		Monroe® OESpectrum® Strut	
Monroe® OESpectrum® Strut		Chevrolet — HHR	06-11 D	Toyota — Highlander	04-07 TI
Nissan — Sentra	02-06 DI	Pontiac — G5	07-09 D	<b>72231</b>	(Pág. 47)
Renault — Scala	11-13 DI	<b>72185</b>	(Pág. 85)	Monroe® OESpectrum® Strut	
<b>72114</b>	(Pág. 126)	Monroe® OESpectrum® Strut		Chevrolet — Uplander	05-09 D
Monroe® OESpectrum® Strut		Honda — Civic	03-05 DD	<b>72237</b>	(Pág. 131)
Toyota — Corolla	03-08 DD	<b>72186</b>	(Pág. 85)	Monroe® OESpectrum® Strut	
<b>72115</b>	(Pág. 126)	Monroe® OESpectrum® Strut		Toyota — Sienna	04-06 DI
Monroe® OESpectrum® Strut		Honda — Civic	03-05 DI	<b>72240</b>	(Pág. 108)
Toyota — Corolla	03-08 DI	<b>72199</b>	(Pág. 38, 115)	Monroe® OESpectrum® Strut	
<b>72117</b>	(Pág. 90, 117, 128)	Monroe® OESpectrum® Strut		Nissan — Maxima	04-08 DD
Monroe® OESpectrum® Strut		Chevrolet — Malibu	04-12 DD	<b>72241</b>	(Pág. 108)
Infiniti — G35	03-05 DI	Pontiac — G6	05-10 DD	Monroe® OESpectrum® Strut	
Pontiac — Vibe	03-08 DI	<b>72200</b>	(Pág. 38, 115)	Nissan — Maxima	04-08 DI
Toyota — Matrix	03-08 DI	Monroe® OESpectrum® Strut		<b>72248</b>	(Pág. 49, 55-56)
<b>72123</b>	(Pág. 84)	Chevrolet — Malibu	04-12 DI	Monroe® OESpectrum® Strut	
Monroe® OESpectrum® Strut		Pontiac — G6	05-10 DI	Chrysler — 300, 300C y 300M	05-10 D
Honda — Accord	03-07 D	<b>72205</b>	(Pág. 97, 125, 132)	Dodge — Challenger	08-10 D
<b>72127</b>	(Pág. 130)	Monroe® OESpectrum® Strut		Dodge — Charger	06-10 D
Monroe® OESpectrum® Strut		Lexus — ES330	04-06 DD	<b>72254</b>	(Pág. 49, 55)
Toyota — RAV4	96-00 DI	Toyota — Camry	04-06 DD	Monroe® OESpectrum® Strut	
<b>72136</b>	(Pág. 86)	Toyota — Solara	04-06 DD	Chrysler — 300, 300C y 300M	05-10 D
Monroe® OESpectrum® Strut		<b>72207</b>	(Pág. 97, 124-125, 132)	Dodge — Charger	06-10 D
Honda — Element	03-06 DI	Monroe® OESpectrum® Strut		<b>72257</b>	(Pág. 69)
<b>72138</b>	(Pág. 70)	Lexus — ES330	04-06 TD	Monroe® OESpectrum® Strut	
Monroe® OESpectrum® Strut		Toyota — Avalon	05-06 TD	Ford — Focus	06-11 DD
Ford — Mustang	05-10 D	Toyota — Camry	04-06 TD	<b>72258</b>	(Pág. 69)
<b>72142</b>	(Pág. 104-105)	Toyota — Solara	04-06 TD	Monroe® OESpectrum® Strut	
Monroe® OESpectrum® Strut		<b>72208</b>	(Pág. 97, 124-125, 132)	Ford — Focus	06-11 DI
Mitsubishi — Lancer	02-07 D	Monroe® OESpectrum® Strut		<b>72261</b>	(Pág. 69, 98100)
<b>72143</b>	(Pág. 86)	Lexus — ES330	04-06 TI	Monroe® OESpectrum® Strut	
Monroe® OESpectrum® Strut		Toyota — Avalon	05-06 TI	Ford — Fusion	06-09 D
Honda — CR-V	02-06 DD	Toyota — Camry	04-06 TI	Lincoln — MKZ	07-09 D
<b>72144</b>	(Pág. 86)	Toyota — Solara	04-06 TI	Mazda — 6S	03-08 D
Monroe® OESpectrum® Strut		<b>72209</b>	(Pág. 36, 116)	<b>72263</b>	(Pág. 99)
Honda — CR-V	02-06 DI	Monroe® Reflex® Strut		Monroe® OESpectrum® Strut	
<b>72147</b>	(Pág. 50-51, 62, 104)	Chevrolet — Equinox	05-06 DD	Mazda — 3	04-13 DD
Monroe® OESpectrum® Strut		<b>72210</b>	(Pág. 36, 116)	Mazda — 5	06-10 DD
Chrysler — Cirrus	01-05 DD	Monroe® Reflex® Strut		<b>72264</b>	(Pág. 99)
Chrysler — Sebring	01-05 DD	Chevrolet — Equinox	05-06 DI	Monroe® OESpectrum® Strut	
Dodge — Sebring	01-05 DD	<b>72211</b>	(Pág. 97, 127)	Mazda — 3	04-13 DI
Dodge — Stratus	01-05 DD	Monroe® OESpectrum® Strut		Mazda — 5	06-10 DI
Mitsubishi — Eclipse	00-05 DD	Lexus — RX330	04-06 DD	<b>72265</b>	(Pág. 103)
<b>72148</b>	(Pág. 50-51, 62, 104)	Lexus — RX350	07-09 DD	Monroe® OESpectrum® Strut	
Monroe® OESpectrum® Strut		Lexus — RX400H	06-07 DD	Mini — Cooper	02-08 DD
Chrysler — Cirrus	01-05 DI	Toyota — Highlander	04-07 DD	<b>72267</b>	(Pág. 108)
Chrysler — Sebring	01-05 DI	<b>72212</b>	(Pág. 97, 127)	Monroe® OESpectrum® Strut	
Dodge — Sebring	01-05 DI	Monroe® OESpectrum® Strut		Nissan — Murano	03-08 DD
Dodge — Stratus	01-05 DI	Lexus — RX330	04-06 DI	<b>72271</b>	(Pág. 110)
Mitsubishi — Eclipse	00-05 DI	Lexus — RX350	07-09 DI	Monroe® OESpectrum® Strut	
<b>72170</b>	(Pág. 95)	Lexus — RX400H	06-07 DI	Nissan — Quest (Mini Van)	04-09 DD
Monroe® OESpectrum® Strut		Toyota — Highlander	04-07 DI		
Kia — Sedona	02-05 DD				

Números de parte con P (P--) indican accesorios con la unidad



# PROGRESIVO AMORTIGUADORES

## INDICE PROGRESIVO DE APLICACIONES

Vehículo	Años Pos.	Vehículo	Años Pos.	Vehículo	Años Pos.
<b>72272</b>	(Pág. 110)	<b>72303</b>	(Pág. 96)	<b>72314 (Cont.)</b>	(Pág. 24-26)
Monroe® OESpectrum® Strut		Monroe® OESpectrum® Strut		Monroe® OESpectrum® Strut	
Nissan — Quest (Mini Van)	04-09 DI	Kia — Spectra	07-09 TD	BMW — 325i	06-13 DI
<b>72275</b>	(Pág. 129-130)	Kia — Spectra	04-06 TD	BMW — 328i (E90)	07-13 DI
Monroe® OESpectrum® Strut		Kia — Spectra 5	05-09 TD	BMW — 330i	06-07 DI
Toyota — RAV4	06-12 DD	<b>72305</b>	(Pág. 88)	BMW — 335i (E90, 92, 93)	07-15 DI
<b>72276</b>	(Pág. 129-130)	Monroe® OESpectrum® Strut		<b>72315</b>	(Pág. 138-137)
Monroe® OESpectrum® Strut		Hyundai — Elantra	07-11 DD	Monroe® OESpectrum® Strut	
Toyota — RAV4	06-12 DI	<b>72306</b>	(Pág. 88)	Volvo — C70	08-13 DD
<b>72283</b>	(Pág. 125)	Monroe® OESpectrum® Strut		Volvo — S40	05-11 DD
Monroe® OESpectrum® Strut		Hyundai — Elantra	07-11 DI	Volvo — V50	05-11 DD
Toyota — Camry	92-94 DI	<b>72307</b>	(Pág. 124-125)	<b>72316</b>	(Pág. 138-137)
<b>72286</b>	(Pág. 85)	Monroe® OESpectrum® Strut		Monroe® OESpectrum® Strut	
Monroe® OESpectrum® Strut		Toyota — Avalon	06-12 DD	Volvo — C70	08-13 DI
Honda — Civic	06-11 DD	Toyota — Camry	07-11 DD	Volvo — S40	05-11 DI
<b>72287</b>	(Pág. 85)	<b>72308</b>	(Pág. 124-125)	Volvo — V50	05-11 DI
Monroe® OESpectrum® Strut		Monroe® OESpectrum® Strut		<b>72317</b>	(Pág. 113)
Honda — Civic	06-11 DI	Toyota — Avalon	06-12 DI	Monroe® OESpectrum® Strut	
<b>72288</b>	(Pág. 129, 133)	Toyota — Camry	07-11 DI	Nissan — X-Trail	01-07 DD
Monroe® OESpectrum® Strut		<b>72309</b>	(Pág. 124)	<b>72318</b>	(Pág. 113)
Toyota — Prius C	12-15 DD	Monroe® OESpectrum® Strut		Monroe® OESpectrum® Strut	
Toyota — Yaris	06-14 DD	Toyota — Avalon	08-12 TD	Nissan — X-Trail	01-07 DI
<b>72289</b>	(Pág. 129, 133)	Toyota — Camry	07-11 TD	<b>72319</b>	(Pág. 113)
Monroe® OESpectrum® Strut		<b>72310</b>	(Pág. 124)	Monroe® OESpectrum® Strut	
Toyota — Prius C	12-15 DI	Monroe® OESpectrum® Strut		Nissan — X-Trail	01-07 TD
Toyota — Yaris	06-14 DI	Toyota — Avalon	08-12 TI	<b>72320</b>	(Pág. 113)
<b>72290</b>	(Pág. 87)	Toyota — Camry	07-11 TI	Monroe® OESpectrum® Strut	
Monroe® OESpectrum® Strut		<b>72311</b>	(Pág. 119, 133-136)	Nissan — X-Trail	01-07 TI
Honda — Fit	06-08 DD	Monroe® OESpectrum® Strut		<b>72322</b>	(Pág. 23)
<b>72291</b>	(Pág. 87)	Seat — Altea	10-12 D	Monroe® OESpectrum® Strut	
Monroe® OESpectrum® Strut			05-06 D	Acura — TL	04-08 D
Honda — Fit	06-08 DI	Volkswagen — Beetle	12-18 D	Acura — TSX	04-08 D
<b>72292</b>	(Pág. 59, 117)	Volkswagen — Bora	05-11 D	<b>72324</b>	(Pág. 23)
Monroe® Reflex® Strut		Volkswagen — CC	09-17 D	Monroe® OESpectrum® Strut	
Dodge — Pickup Ram 1500	09-18 D	Volkswagen — Eos	07-16 D	Acura — TSX	04-08 T
RAM — Serie 1500	11-18 D	Volkswagen — Golf SportWagen	10-13 D	<b>72327</b>	(Pág. 119)
<b>72293</b>	(Pág. 97)	Volkswagen — Jetta	11-18 D	Monroe® OESpectrum® Strut	
Monroe® OESpectrum® Strut		Volkswagen — Passat	2012 D	Saab — 9-3	03-08 DD
Lincoln — Aviator	03-05 D		06-10 D	<b>72328</b>	(Pág. 119)
<b>72294</b>	(Pág. 97)	Volkswagen — Passat CC	09-12 D	Monroe® OESpectrum® Strut	
Monroe® OESpectrum® Strut		<b>72312</b>	(Pág. 24, 134-137)	Saab — 9-3	03-08 DI
Lincoln — Aviator	03-05 T	Monroe® OESpectrum® Strut		<b>72332</b>	(Pág. 49)
<b>72295</b>	(Pág. 32, 115)	Audi — A3	05-13 D	Monroe® OESpectrum® Strut	
Monroe® OESpectrum® Strut		Volkswagen — Bora	05-11 D	Chrysler — 200	11-14 DD
Chevrolet — Aveo	04-18 DD	Volkswagen — GTI	06-14 D	<b>72333</b>	(Pág. 49)
Pontiac — G3	06-09 DD	Volkswagen — Passat	06-10 D	Monroe® OESpectrum® Strut	
<b>72296</b>	(Pág. 32, 115)	Volkswagen — Tiguan	09-17 D	Chrysler — 200	11-14 DI
Monroe® OESpectrum® Strut		<b>72313</b>	(Pág. 24-26)	<b>72343</b>	(Pág. 87)
Chevrolet — Aveo	04-18 DI	Monroe® OESpectrum® Strut		Monroe® OESpectrum® Strut	
Pontiac — G3	06-09 DI	BMW — 128	08-13 DD	Honda — Ridgeline	06-14 DD
<b>72297</b>	(Pág. 53, 95)	BMW — 135	08-13 DD	<b>72347</b>	(Pág. 104)
Monroe® OESpectrum® Strut		BMW — 325i	06-13 DD	Monroe® OESpectrum® Strut	
Dodge — Attitude	06-11 DD	BMW — 328i (E90)	07-13 DD	Mitsubishi — Galant	04-11 DD
<b>72298</b>	(Pág. 53, 95)	BMW — 330i	06-07 DD	<b>72351</b>	(Pág. 111)
Monroe® OESpectrum® Strut		BMW — 335i (E90, 92, 93)	07-15 DD	Monroe® OESpectrum® Strut	
Dodge — Attitude	06-11 DI	<b>72314</b>	(Pág. 24-26)	Nissan — Tiida	07-18 DD
		Monroe® OESpectrum® Strut			
		BMW — 128	08-13 DI		
		BMW — 135	08-13 DI		

Números de parte con P (P-) indican accesorios con la unidad



# PROGRESIVO AMORTIGUADORES

## INDICE PROGRESIVO DE APLICACIONES

Vehículo	Años Pos.	Vehículo	Años Pos.	Vehículo	Años Pos.
<b>72352</b>	(Pág. 111)	<b>72399</b>	(Pág. 104)	<b>72450</b>	(Pág. 39)
Monroe® OESpectrum® Strut		Monroe® OESpectrum® Strut		Monroe® OESpectrum® Strut	
Nissan — Tiida	07-18 DI	Mitsubishi — Lancer	12-16 TD	Chevrolet — Optra	06-10 TI
<b>72355</b>	(Pág. 104)		12-16 TI	<b>72451</b>	(Pág. 39)
Monroe® OESpectrum® Strut			08-10 TD	Monroe® OESpectrum® Strut	
Mitsubishi — Lancer	08-10 DD	<b>72400</b>	(Pág. 120)	Chevrolet — Optra	06-10 TD
<b>72356</b>	(Pág. 104)	Monroe® OESpectrum® Strut		<b>72465</b>	(Pág. 123)
Monroe® OESpectrum® Strut		Scion — tC	05-10 TD	Monroe® OESpectrum® Strut	
Mitsubishi — Lancer	08-10 DI		05-10 TI	Suzuki — Aerio	02-07 TD
<b>72358</b>	(Pág. 129)	<b>72401</b>	(Pág. 54, 92-93)	<b>72468</b>	(Pág. 123)
Monroe® OESpectrum® Strut		Monroe® OESpectrum® Strut		Monroe® OESpectrum® Strut	
Toyota — Prius	04-09 DI	Dodge — Caliber	07-12 TD	Suzuki — Aerio	04-07 DI
<b>72362</b>	(Pág. 33, 115)		07-12 TI	<b>72469</b>	(Pág. 123)
Monroe® OESpectrum® Strut		Jeep — Compass	07-10 TD	Monroe® OESpectrum® Strut	
Chevrolet — Camaro	93-02 D		07-10 TI	Suzuki — Aerio	04-07 DD
Pontiac — Firebird	93-02 DD	Jeep — Patriot	07-10 TD	<b>72476</b>	(Pág. 137)
	93-02 DI		07-10 TI	Monroe® OESpectrum® Strut	
<b>72367</b>	(Pág. 54, 92-93)	<b>72408</b>	(Pág. 49, 56)	Volkswagen — Touareg	04-12 DD
Monroe® OESpectrum® Strut		Monroe® OESpectrum® Strut		<b>72477</b>	(Pág. 137)
Dodge — Caliber	07-12 DD	Chrysler — 300, 300C y 300M	05-10 D	Monroe® OESpectrum® Strut	
Jeep — Compass	07-10 DD	Dodge — Charger	06-10 D	Volkswagen — Touareg	04-12 DI
Jeep — Patriot	07-10 DD	<b>72418</b>	(Pág. 105)	<b>72478</b>	(Pág. 137)
<b>72368</b>	(Pág. 54, 92-93)	Monroe® OESpectrum® Strut		Monroe® OESpectrum® Strut	
Monroe® OESpectrum® Strut		Mitsubishi — Outlander	03-06 D	Volkswagen — Touareg	04-12 TD
Dodge — Caliber	07-12 DI	<b>72423</b>	(Pág. 123)		04-12 TI
Jeep — Compass	07-10 DI	Monroe® OESpectrum® Strut		<b>72479</b>	(Pág. 77)
Jeep — Patriot	07-10 DI	Suzuki — Grand Vitara	06-17 DD	Monroe® OESpectrum® Strut	
<b>72378</b>	(Pág. 110)	<b>72424</b>	(Pág. 123)	Ford — Transit	10-13 D
Monroe® OESpectrum® Strut		Monroe® OESpectrum® Strut			99-01 D
Nissan — Sentra	07-12 DD	Suzuki — Grand Vitara	06-17 DI	<b>72480</b>	(Pág. 103)
<b>72379</b>	(Pág. 110)	<b>72425</b>	(Pág. 121)	Monroe® OESpectrum® Strut	
Monroe® OESpectrum® Strut		Monroe® OESpectrum® Strut		Mini — Cooper	07-16 DD
Nissan — Sentra	07-12 DI	Subaru — Forester	06-08 DD	<b>72481</b>	(Pág. 103)
<b>72384</b>	(Pág. 125)	<b>72426</b>	(Pág. 121)	Monroe® OESpectrum® Strut	
Monroe® OESpectrum® Strut		Subaru — Forester	06-08 DI	Mini — Cooper	07-16 DI
Toyota — Camry	07-11 TD	<b>72433</b>	(Pág. 23)	<b>72482</b>	(Pág. 103)
<b>72385</b>	(Pág. 125)	Monroe® OESpectrum® Strut		Monroe® OESpectrum® Strut	
Monroe® OESpectrum® Strut		Acura — MDX	07-13 DD	Mini — Cooper	07-16 TD
Toyota — Camry	07-11 TI	<b>72434</b>	(Pág. 23)		07-16 TI
<b>72390</b>	(Pág. 120)	Monroe® OESpectrum® Strut		<b>72483</b>	(Pág. 127)
Monroe® OESpectrum® Strut		Acura — MDX	07-13 DI	Monroe® OESpectrum® Strut	
Scion — tC	05-10 DD	<b>72437</b>	(Pág. 105)	Toyota — Highlander	08-10 DD
<b>72391</b>	(Pág. 120)	Monroe® OESpectrum® Strut		<b>72485</b>	(Pág. 127, 133)
Monroe® OESpectrum® Strut		Mitsubishi — Outlander	07-13 DD	Monroe® OESpectrum® Strut	
Scion — tC	05-10 DI	<b>72438</b>	(Pág. 105)	Toyota — Highlander	08-13 TD
<b>72392</b>	(Pág. 106)	Monroe® OESpectrum® Strut		Toyota — Venza	09-12 TD
Monroe® OESpectrum® Strut		Mitsubishi — Outlander	07-13 DI	<b>72486</b>	(Pág. 127, 133)
Nissan — Altima	07-12 DD	<b>72445</b>	(Pág. 121)	Monroe® OESpectrum® Strut	
<b>72393</b>	(Pág. 106)	Monroe® OESpectrum® Strut		Toyota — Highlander	08-13 TI
Monroe® OESpectrum® Strut		Subaru — Forester	06-08 TD	Toyota — Venza	09-12 TI
Nissan — Altima	07-12 DI	<b>72446</b>	(Pág. 121)	<b>72489</b>	(Pág. 127, 133)
<b>72398</b>	(Pág. 87)	Monroe® OESpectrum® Strut		Monroe® OESpectrum® Strut	
Monroe® OESpectrum® Strut		Subaru — Forester	06-08 TI	Toyota — Highlander	08-13 TD
Honda — Ridgeline	06-14 TD			Toyota — Venza	09-12 TD
	06-14 TI				

Números de parte con P (P--) indican accesorios con la unidad



# PROGRESIVO AMORTIGUADORES

## INDICE PROGRESIVO DE APLICACIONES

Vehículo	Años Pos.	Vehículo	Años Pos.	Vehículo	Años Pos.
<b>72490</b>	(Pág. 127, 133)	<b>72519</b>	(Pág. 134, 137)	<b>72537</b>	(Pág. 87)
Monroe® OESpectrum® Strut		Monroe® OESpectrum® Strut		Monroe® OESpectrum® Strut	
Toyota — Highlander	08-13 TI	Volkswagen — Eurovan TDI	05-09 D	Honda — Odyssey (Mini Van)	05-07 DI
Toyota — Venza	09-12 TI	<b>72520</b>	(Pág. 116)	<b>72538</b>	(Pág. 68)
<b>72491</b>	(Pág. 86)	Monroe® OESpectrum® Strut		Monroe® OESpectrum® Strut	
Monroe® OESpectrum® Strut		Pontiac — Matiz	04-05 DD	Ford — Five Hundred	05-07 TD
Honda — CR-V	07-14 DD	<b>72521</b>	(Pág. 116)		05-07 TI
<b>72492</b>	(Pág. 86)	Monroe® OESpectrum® Strut		<b>72539</b>	(Pág. 67)
Monroe® OESpectrum® Strut		Pontiac — Matiz	04-05 DI	Monroe® OESpectrum® Strut	
Honda — CR-V	07-14 DI	<b>72522</b>	(Pág. 69)	Ford — Five Hundred	05-07 T
<b>72493</b>	(Pág. 100)	Monroe® OESpectrum® Strut		<b>72540</b>	(Pág. 70)
Monroe® OESpectrum® Strut		Ford — Focus	12-13 DD	Monroe® OESpectrum® Strut	
Mazda — CX-7	07-12 DD	<b>72523</b>	(Pág. 69)	Ford — Mustang	11-14 D
<b>72494</b>	(Pág. 100)	Monroe® OESpectrum® Strut		<b>72541</b>	(Pág. 87)
Monroe® OESpectrum® Strut		Ford — Focus	12-13 DI	Monroe® OESpectrum® Strut	
Mazda — CX-7	07-12 DI	<b>72524</b>	(Pág. 67)	Honda — Odyssey (Mini Van)	08-10 DD
<b>72496</b>	(Pág. 101)	Monroe® OESpectrum® Strut		<b>72542</b>	(Pág. 87)
Monroe® OESpectrum® Strut		Ford — Fiesta	11-13 DD	Monroe® OESpectrum® Strut	
Mazda — MX-5 Miata	06-12 T	<b>72525</b>	(Pág. 67)	Honda — Odyssey (Mini Van)	08-10 DI
<b>72497</b>	(Pág. 86)	Monroe® OESpectrum® Strut		<b>72544</b>	(Pág. 99)
Monroe® OESpectrum® Strut		Ford — Fiesta	11-13 DI	Monroe® OESpectrum® Strut	
Honda — CR-V	07-11 TD	<b>72526</b>	(Pág. 33-33, 36, 116)	Mazda — 2	11-14 DD
	07-11 TI	Monroe® OESpectrum® Strut		<b>72545</b>	(Pág. 99)
<b>72501</b>	(Pág. 122)	Chevrolet — Captiva	08-11 DD	Monroe® OESpectrum® Strut	
Monroe® OESpectrum® Strut		Chevrolet — Captiva Sport	12-15 DD	Mazda — 2	11-14 DI
Subaru — Legacy	05-09 TI	Chevrolet — Equinox	07-17 DD	<b>72546</b>	(Pág. 57, 93)
<b>72504</b>	(Pág. 104)	Pontiac — Torrent	07-09 DD	Monroe® OESpectrum® Strut	
Monroe® OESpectrum® Strut		<b>72527</b>	(Pág. 33-33, 36, 116)	Dodge — Durango	11-16 D
Mitsubishi — Lancer	08-16 DD	Monroe® OESpectrum® Strut		Jeep — Grand Cherokee	11-15 D
<b>72508</b>	(Pág. 104)	Chevrolet — Captiva	08-11 DI	<b>72547</b>	(Pág. 28)
Monroe® OESpectrum® Strut		Chevrolet — Captiva Sport	12-15 DI	Monroe® OESpectrum® Strut	
Mitsubishi — Lancer	08-11 TD	Chevrolet — Equinox	07-17 DI	BMW — X3	04-11 DD
	08-11 TI	Pontiac — Torrent	07-09 DI	<b>72548</b>	(Pág. 28)
<b>72509</b>	(Pág. 58)	<b>72528</b>	(Pág. 29-30, 38)	Monroe® OESpectrum® Strut	
Monroe® OESpectrum® Strut		Monroe® OESpectrum® Strut		BMW — X3	04-11 DI
Dodge — Journey	09-19 DD	Buick — LaCrosse	10-15 DD	<b>72549</b>	(Pág. 135)
<b>72510</b>	(Pág. 58)	<b>72529</b>	(Pág. 29-30, 38)	Monroe® OESpectrum® Strut	
Monroe® OESpectrum® Strut		Monroe® OESpectrum® Strut		Volkswagen — Jetta	11-15 D
Dodge — Journey	09-19 DI	Buick — LaCrosse	10-15 DI	<b>72560</b>	(Pág. 87)
<b>72511</b>	(Pág. 58)	<b>72532</b>	(Pág. 98)	Monroe® OESpectrum® Strut	
Monroe® OESpectrum® Strut		Lincoln — MKS	09-12 DI	Honda — Odyssey (Mini Van)	11-12 DD
Dodge — Journey	09-10 TD	<b>72533</b>	(Pág. 98)	<b>72561</b>	(Pág. 87)
	09-10 TI	Monroe® OESpectrum® Strut		Monroe® OESpectrum® Strut	
<b>72516</b>	(Pág. 29)	Lincoln — MKS	09-12 DD	Honda — Odyssey (Mini Van)	11-12 DI
Monroe® OESpectrum® Strut		<b>72534</b>	(Pág. 68, 98)	<b>72562</b>	(Pág. 84)
Buick — LaCrosse	10-15 DI	Monroe® OESpectrum® Strut		Monroe® OESpectrum® Strut	
<b>72517</b>	(Pág. 56)	Ford — Flex	2009 DI	Honda — Accord	08-12 D
Monroe® OESpectrum® Strut		Lincoln — MKT	10-12 DI	<b>72563</b>	(Pág. 84)
Dodge — Dakota	10-12 D	<b>72535</b>	(Pág. 68, 98)	Monroe® OESpectrum® Strut	
<b>72518</b>	(Pág. 29, 47, 78)	Monroe® OESpectrum® Strut		Honda — Accord	08-12 T
Monroe® OESpectrum® Strut		Ford — Flex	2009 DD	<b>72567</b>	(Pág. 122)
Buick — Enclave	08-12 D	Lincoln — MKT	10-12 DD	Monroe® OESpectrum® Strut	
Chevrolet — Traverse	09-12 D	<b>72536</b>	(Pág. 87)	Subaru — Outback	05-09 TD
GMC — Acadia	07-12 D	Monroe® OESpectrum® Strut			05-09 TI
		Honda — Odyssey (Mini Van)	05-07 DD		

Números de parte con P (P--) indican accesorios con la unidad



# PROGRESIVO AMORTIGUADORES

## INDICE PROGRESIVO DE APLICACIONES

Vehículo	Años Pos.	Vehículo	Años Pos.	Vehículo	Años Pos.
<b>72568</b>	(Pág. 100)	<b>72599</b>	(Pág. 116, 126, 128)	<b>72626</b>	(Pág. 35-36)
Monroe® OESpectrum® Strut		Monroe® OESpectrum® Strut		Monroe® OESpectrum® Strut	
Mazda — 6	09-13 DD	Pontiac — Vibe	09-10 T	Chevrolet — Cruze	10-12 DD
<b>72569</b>	(Pág. 100)	Toyota — Corolla	09-13 TD	<b>72627</b>	(Pág. 35-36)
Monroe® OESpectrum® Strut		Toyota — Matrix	09-13 TI	Monroe® OESpectrum® Strut	
Mazda — 6	09-13 DI	<b>72600</b>	(Pág. 116, 128)	Chevrolet — Cruze	10-12 DI
<b>72576</b>	(Pág. 76-77)	Monroe® OESpectrum® Strut		<b>72631</b>	(Pág. 30)
Monroe® OESpectrum® Strut		Pontiac — Vibe	09-10 TD	Monroe® OESpectrum® Strut	
Ford — Taurus X	08-09 DI	Toyota — Matrix	09-13 TD	Cadillac — ATS	13-18 DD
<b>72577</b>	(Pág. 76-77)	Toyota — Matrix	09-13 TI	<b>72632</b>	(Pág. 30)
Monroe® OESpectrum® Strut		<b>72601</b>	(Pág. 106, 118-119)	Monroe® OESpectrum® Strut	
Ford — Taurus X	08-09 DD	Monroe® OESpectrum® Strut		Cadillac — ATS	13-18 DI
<b>72587</b>	(Pág. 89, 94)	Nissan — Aprio	07-10 D	<b>72633</b>	(Pág. 134-136)
Monroe® OESpectrum® Strut		Renault — Logan	15-18 D	Monroe® OESpectrum® Strut	
Hyundai — Sonata	12-14 DI	Renault — Sandero	10-18 D	Volkswagen — Gol	08-18 D
Kia — Optima	12-15 DD	Renault — Stepway	10-11 D	Volkswagen — Gol Sedán	10-13 D
<b>72588</b>	(Pág. 89, 94)	<b>72602</b>	(Pág. 38, 116)	Volkswagen — Nuevo Gol	14-16 D
Monroe® OESpectrum® Strut		Monroe® OESpectrum® Strut		<b>72634</b>	(Pág. 134-136)
Hyundai — Sonata	12-14 DD	Chevrolet — Matiz	11-15 DD	Monroe® OESpectrum® Strut	
Kia — Optima	12-15 DI	Pontiac — Matiz	06-10 DD	Volkswagen — Gol	08-18 T
<b>72589</b>	(Pág. 50-51, 62, 114-115)	<b>72603</b>	(Pág. 38, 116)	Volkswagen — Gol Sedán	10-13 T
Monroe® OESpectrum® Strut		Monroe® OESpectrum® Strut		Volkswagen — Nuevo Gol	14-16 T
Chrysler — LeBaron	89-94 D	Chevrolet — Matiz	11-15 DI	<b>72635</b>	(Pág. 101)
Chrysler — New Yorker y Fifth Avenue	86-87 D	Pontiac — Matiz	06-10 DI	Monroe® OESpectrum® Strut	
Dodge — Shadow	89-94 D	<b>72604</b>	(Pág. 108)	Mercedes Benz — Clase C	08-12 D
Dodge — Spirit	89-95 D	Monroe® OESpectrum® Strut		<b>72637</b>	(Pág. 138)
Plymouth — Acclaim	89-95 D	Nissan — Maxima	09-14 DD	Monroe® OESpectrum® Strut	
Plymouth — Sundance	89-94 D	<b>72605</b>	(Pág. 108)	Volvo — S80	06-15 DI
<b>72591</b>	(Pág. 52, 55)	Monroe® OESpectrum® Strut		<b>72639</b>	(Pág. 90)
Monroe® OESpectrum® Strut		Nissan — Maxima	09-14 DI	Monroe® OESpectrum® Strut	
Chrysler — Town & Country	90-95 D	<b>72607</b>	(Pág. 108)	Hyundai — Veracruz	07-12 D
Chrysler — Voyager y Grand Voyager	86-94 D	Monroe® OESpectrum® Strut		<b>72641</b>	(Pág. 56-57)
Dodge — Caravan y Grand Caravan	86-95 D	Nissan — Murano	09-10 DI	Monroe® OESpectrum® Strut	
<b>72595</b>	(Pág. 69, 77)	<b>72608</b>	(Pág. 110)	Dodge — Dart	13-16 DD
Monroe® OESpectrum® Strut		Monroe® OESpectrum® Strut		<b>72642</b>	(Pág. 56-57)
Ford — Freestyle	05-07 TD	Nissan — Rogue	08-12 DD	Monroe® OESpectrum® Strut	
Ford — Taurus X	08-09 TD	<b>72609</b>	(Pág. 110)	Dodge — Dart	13-16 DI
Ford — Taurus X	08-09 TI	Monroe® OESpectrum® Strut		<b>72645</b>	(Pág. 118)
<b>72596</b>	(Pág. 69, 98)	Nissan — Rogue	08-12 DI	Monroe® OESpectrum® Strut	
Monroe® OESpectrum® Strut		<b>72610</b>	(Pág. 69)	Renault — Megane, Megane II	04-10 D
Ford — Fusion	10-12 D	Monroe® OESpectrum® Strut		<b>72647</b>	(Pág. 87)
Lincoln — MKZ	10-12 D	Ford — Freestyle	05-07 DI	Monroe® OESpectrum® Strut	
<b>72597</b>	(Pág. 116, 126, 128)	<b>72612</b>	(Pág. 68)	Honda — Pilot	09-15 DD
Monroe® OESpectrum® Strut		Monroe® OESpectrum® Strut		<b>72648</b>	(Pág. 87)
Pontiac — Vibe	09-10 DD	Ford — Five Hundred	05-07 DI	Monroe® OESpectrum® Strut	
Toyota — Corolla	09-13 DD	<b>72613</b>	(Pág. 68)	Honda — Pilot	09-15 DI
Toyota — Matrix	09-13 DD	Monroe® OESpectrum® Strut		<b>72663</b>	(Pág. 30, 35)
<b>72598</b>	(Pág. 116, 126, 128)	Ford — Five Hundred	05-07 DD	Monroe® OESpectrum® Strut	
Monroe® OESpectrum® Strut		<b>72620</b>	(Pág. 66)	Buick — Verano	12-17 DD
Pontiac — Vibe	09-10 DI	Monroe® OESpectrum® Strut		Chevrolet — Cruze	12-15 DD
Toyota — Corolla	09-13 DI	Ford — Explorer	11-12 DD	<b>72664</b>	(Pág. 30, 35)
Toyota — Matrix	09-13 DI	<b>72621</b>	(Pág. 66)	Monroe® OESpectrum® Strut	
		Monroe® OESpectrum® Strut		Buick — Verano	12-17 DI
		Ford — Explorer	11-12 DI	Chevrolet — Cruze	12-15 DI

Números de parte con P (P--) indican accesorios con la unidad



# PROGRESIVO AMORTIGUADORES

## INDICE PROGRESIVO DE APLICACIONES

Vehículo	Años Pos.	Vehículo	Años Pos.	Vehículo	Años Pos.
<b>72665</b>	(Pág. 49, 55)	<b>72690</b>	(Pág. 122)	<b>72722</b>	(Pág. 96)
Monroe® OESpectrum® Strut Dodge — Challenger	11-19 D	Monroe® OESpectrum® Strut Subaru — Legacy	10-12 TI 05-12 TD	Monroe® OESpectrum® Strut Kia — Sportage	11-16 D
<b>72668</b>	(Pág. 34, 109)	<b>72691</b>	(Pág. 122)	<b>72723</b>	(Pág. 96)
Monroe® OESpectrum® Strut Chevrolet — City Express	15-18 DD	Monroe® OESpectrum® Strut Subaru — Outback	10-12 TD 10-12 TI	Monroe® OESpectrum® Strut Kia — Sportage	11-16 D
<b>72669</b>	(Pág. 34, 109)	<b>72692</b>	(Pág. 23)	<b>72729</b>	(Pág. 66)
Monroe® OESpectrum® Strut Chevrolet — City Express	15-18 DI	Monroe® OESpectrum® Strut Acura — TL	09-14 TD 09-14 TI	Monroe® OESpectrum® Strut Ford — Explorer	12-19 DD
<b>72670</b>	(Pág. 120)	<b>72693</b>	(Pág. 23)	<b>72730</b>	(Pág. 66)
Monroe® OESpectrum® Strut Scion — xB	08-15 DD	Monroe® OESpectrum® Strut Acura — TSX	09-14 TD 09-14 TI	Monroe® OESpectrum® Strut Ford — Explorer	12-19 DI
<b>72671</b>	(Pág. 120)	<b>72696</b>	(Pág. 121)	<b>72731</b>	(Pág. 26-28)
Monroe® OESpectrum® Strut Scion — xB	08-15 DI	Monroe® OESpectrum® Strut Subaru — Forester	09-13 TD 09-13 TI	Monroe® OESpectrum® Strut BMW — 525i	04-07 DD
<b>72678</b>	(Pág. 121)	<b>72699</b>	(Pág. 121)	BMW — 528i	08-10 DD
Monroe® OESpectrum® Strut Subaru — Forester	09-13 DD	Monroe® OESpectrum® Strut Subaru — Forester	09-13 TD 09-13 TI	BMW — 530i	04-07 DD
<b>72679</b>	(Pág. 121)	<b>72702</b>	(Pág. 90-91)	BMW — 535i	08-10 DD
Monroe® OESpectrum® Strut Subaru — Forester	09-13 DI	Monroe® OESpectrum® Strut Infiniti — EX35	09-12 DD	BMW — 545i	04-05 DD
<b>72680</b>	(Pág. 121)	<b>72703</b>	(Pág. 90-91)	BMW — 550i	06-10 DD
Monroe® OESpectrum® Strut Subaru — Impreza	08-11 DD	Monroe® OESpectrum® Strut Infiniti — FX50	09-11 DI	<b>72732</b>	(Pág. 26-28)
<b>72681</b>	(Pág. 121)	<b>72706</b>	(Pág. 53, 95)	Monroe® OESpectrum® Strut BMW — 525i	04-07 DI
Monroe® OESpectrum® Strut Subaru — Impreza	08-11 DI	Monroe® OESpectrum® Strut Dodge — Attitude	12-14 DD	BMW — 528i	08-10 DI
<b>72682</b>	(Pág. 120, 129)	<b>72707</b>	(Pág. 53, 95)	BMW — 530i	04-07 DI
Monroe® OESpectrum® Strut Scion — tC	11-16 DD	Monroe® OESpectrum® Strut Dodge — Attitude	12-14 DI	BMW — 535i	08-10 DD
<b>72683</b>	(Pág. 120, 129)	<b>72708</b>	(Pág. 88)	BMW — 545i	04-05 DD
Monroe® OESpectrum® Strut Scion — tC	11-16 DI	Monroe® OESpectrum® Strut Hyundai — Elantra	11-16 DD	BMW — 550i	06-10 DI
<b>72684</b>	(Pág. 122)	<b>72709</b>	(Pág. 88)	<b>72733</b>	(Pág. 26-28)
Monroe® OESpectrum® Strut Subaru — Legacy	10-12 DD	Monroe® OESpectrum® Strut Hyundai — Elantra	11-16 DI	Monroe® OESpectrum® Strut BMW — 525i	04-07 DI
<b>72685</b>	(Pág. 122)	<b>72720</b>	(Pág. 94)	BMW — 528i	08-10 DI
Monroe® OESpectrum® Strut Subaru — Legacy	10-12 DI	Monroe® OESpectrum® Strut Kia — Forte	10-13 DD	BMW — 530i	04-07 DI
<b>72686</b>	(Pág. 122)	<b>72721</b>	(Pág. 94)	BMW — 535i	08-10 DI
Monroe® OESpectrum® Strut Subaru — Outback	10-12 DD	Monroe® OESpectrum® Strut Kia — Forte	10-13 DI	BMW — 545i	04-05 DI
<b>72687</b>	(Pág. 122)	<b>72738</b>	(Pág. 106)	BMW — 550i	06-10 DI
Monroe® OESpectrum® Strut Subaru — Outback	10-12 DI	Monroe® OESpectrum® Strut Nissan — Cube	09-14 DI	<b>72739</b>	(Pág. 124)
<b>72688</b>	(Pág. 129)	<b>72739</b>	(Pág. 124)	Monroe® OESpectrum® Strut Toyota — Avalon	05-06 DD
Monroe® OESpectrum® Strut Toyota — Prius	10-17 DD	Monroe® OESpectrum® Strut Toyota — Avalon	05-06 DI	<b>72740</b>	(Pág. 124)
<b>72689</b>	(Pág. 129)	<b>72746</b>	(Pág. 26-28)	Monroe® OESpectrum® Strut Toyota — Avalon	05-06 DI
Monroe® OESpectrum® Strut Toyota — Prius	10-17 DI	Monroe® OESpectrum® Strut BMW — 525i	04-07 TD	<b>72746</b>	(Pág. 26-28)
		BMW — 528i	08-10 TD	Monroe® OESpectrum® Strut BMW — 525i	04-07 TI
			08-10 TI	BMW — 528i	08-10 TD
					08-10 TI

Números de parte con P (P-) indican accesorios con la unidad



# PROGRESIVO AMORTIGUADORES

## INDICE PROGRESIVO DE APLICACIONES

Vehículo	Años Pos.	Vehículo	Años Pos.	Vehículo	Años Pos.
<b>72746</b> (Cont.)	(Pág. 26-28)	<b>72780</b>	(Pág. 51, 54, 62)	<b>72895</b>	(Pág. 58)
Monroe® OESpectrum® Strut		Monroe® OESpectrum® Strut		Monroe® OESpectrum® Strut	
BMW — 530i	04-07 TD	Chrysler — Town & Country	12-16 D	Dodge — Journey	09-10 TD
	04-07 TI	Dodge — Caravan y Grand Caravan	12-16 D		09-10 TI
BMW — 535i	08-10 TD			<b>72896</b>	(Pág. 58)
	08-10 TI	Dodge — Ram Cargo Caravan (C/V)	12-15 D	Monroe® OESpectrum® Strut	
BMW — 545i	04-05 TD			Dodge — Journey	11-19 TD
	04-05 TI	<b>72781</b>	(Pág. 130-131)		11-19 TI
BMW — 550i	06-10 TD	Monroe® OESpectrum® Strut		<b>72900</b>	(Pág. 66, 98)
	06-10 TI	Toyota — Sienna	11-14 DD	Monroe® OESpectrum® Strut	
<b>72750</b>	(Pág. 65)	<b>72782</b>	(Pág. 130-131)	Ford — Expedition	14-17 D
Monroe® OESpectrum® Strut		Monroe® OESpectrum® Strut		Lincoln — Navigator	14-17 D
Ford — Escape	2019 DD	Toyota — Sienna	11-14 DI	<b>72901</b>	(Pág. 105)
<b>72751</b>	(Pág. 65)	<b>72785</b>	(Pág. 67)	Monroe® OESpectrum® Strut	
Monroe® OESpectrum® Strut		Monroe® OESpectrum® Strut		Nissan — Altima	13-18 DD
Ford — Escape	2019 DI	Ford — Fiesta	14-15 DD	<b>72902</b>	(Pág. 105)
<b>72753</b>	(Pág. 97)	<b>72786</b>	(Pág. 67)	Monroe® OESpectrum® Strut	
Monroe® OESpectrum® Strut		Monroe® OESpectrum® Strut		Nissan — Altima	13-18 DI
Lincoln — MKC	15-19 DI	Ford — Fiesta	14-15 DI	<b>72903</b>	(Pág. 37)
<b>72755</b>	(Pág. 24-26)	<b>72787</b>	(Pág. 77)	Monroe® OESpectrum® Strut	
Monroe® OESpectrum® Strut		Monroe® OESpectrum® Strut		Chevrolet — Impala Limited	14-16 DD
BMW — 128	08-13 DD	Ford — Transit	14-18 DD		14-16 DI
BMW — 135	08-13 DD	<b>72788</b>	(Pág. 77)	<b>72907</b>	(Pág. 68)
BMW — 323i	07-10 DD	Monroe® OESpectrum® Strut		Monroe® OESpectrum® Strut	
BMW — 328i (E90)	07-13 DD	Ford — Transit	14-18 DI	Ford — Focus	13-18 DD
BMW — 335i (E90, 92, 93)	07-13 DD	<b>72826</b>	(Pág. 133-134)	<b>72908</b>	(Pág. 68)
<b>72756</b>	(Pág. 24-26)	Monroe® OESpectrum® Cartucho		Monroe® OESpectrum® Strut	
Monroe® OESpectrum® Strut		Volkswagen — Atlantic	81-87 D	Ford — Focus	13-18 DI
BMW — 128	08-13 DI	Volkswagen — Cabriolet	85-93 D	<b>72909</b>	(Pág. 31)
BMW — 135	08-13 DI	Volkswagen — Caribe	77-87 D	Monroe® OESpectrum® Strut	
BMW — 323i	07-10 DI	<b>72888</b>	(Pág. 64-65, 98)	Cadillac — SRX	10-15 D
BMW — 328i (E90)	07-13 DI	Monroe® OESpectrum® Strut		<b>72910</b>	(Pág. 38)
BMW — 335i (E90, 92, 93)	07-13 DI	Ford — Edge	07-14 DD	Monroe® OESpectrum® Strut	
<b>72765</b>	(Pág. 97, 127)	Lincoln — MKX	07-15 DD	Chevrolet — Malibu	14-15 DD
Monroe® OESpectrum® Strut		<b>72889</b>	(Pág. 64-65, 98)	<b>72911</b>	(Pág. 38)
Lexus — RX350	10-15 DD	Monroe® OESpectrum® Strut		Monroe® OESpectrum® Strut	
Toyota — Highlander	10-13 DD	Ford — Edge	07-14 DI	Chevrolet — Malibu	14-15 DI
<b>72766</b>	(Pág. 97, 127)	Lincoln — MKX	07-15 DI	<b>72913</b>	(Pág. 33)
Monroe® OESpectrum® Strut		<b>72890</b>	(Pág. 49)	Monroe® OESpectrum® Strut	
Lexus — RX350	10-15 DI	Monroe® OESpectrum® Strut		Chevrolet — Camaro	13-15 DI
Toyota — Highlander	10-13 DI	Chrysler — Atos	00-12 DD	<b>72915</b>	(Pág. 33)
<b>72770</b>	(Pág. 23)	<b>72891</b>	(Pág. 49)	Monroe® OESpectrum® Strut	
Monroe® OESpectrum® Strut		Monroe® OESpectrum® Strut		Chevrolet — Camaro	13-15 DI
Acura — TSX	09-14 DD	Chrysler — Atos	00-12 DI	<b>72916</b>	(Pág. 28)
<b>72772</b>	(Pág. 97)	<b>72892</b>	(Pág. 32)	Monroe® OESpectrum® Strut	
Monroe® OESpectrum® Strut		Monroe® OESpectrum® Strut		BMW — X5	07-13 DD
Lexus — RX350	07-09 TD	Chevrolet — Astra	00-08 DD		07-13 DI
<b>72773</b>	(Pág. 97)	<b>72893</b>	(Pág. 32)	<b>72918</b>	(Pág. 88, 95)
Monroe® OESpectrum® Strut		Monroe® OESpectrum® Strut		Monroe® OESpectrum® Strut	
Lexus — RX350	07-09 TI	Chevrolet — Astra	00-08 DI	Hyundai — Entourage	07-08 DI
<b>72778</b>	(Pág. 67)	<b>72894</b>	(Pág. 58)	Kia — Sedona	06-12 DI
Monroe® OESpectrum® Strut		Monroe® OESpectrum® Strut		<b>72919</b>	(Pág. 34-35, 78-79)
Ford — Fiesta	14-19 DD	Dodge — Journey	09-10 TD	Monroe® OESpectrum® Strut	
<b>72779</b>	(Pág. 67)		09-10 TI	Chevrolet — Colorado Pickup	15-18 D
Monroe® OESpectrum® Strut					
Ford — Fiesta	14-19 DI				

Números de parte con P (P--) indican accesorios con la unidad



# PROGRESIVO AMORTIGUADORES

## INDICE PROGRESIVO DE APLICACIONES

Vehículo	Años Pos.	Vehículo	Años Pos.	Vehículo	Años Pos.
<b>72921</b>	(Pág. 101)	<b>72941</b>	(Pág. 124)	<b>72960</b>	(Pág. 121)
Monroe® OESpectrum® Strut		Monroe® OESpectrum® Strut		Monroe® OESpectrum® Strut	
Mazda — CX-9	07-15 DI	Toyota — Camry	12-17 DI	Subaru — Impreza	12-14 DD
<b>72922</b>	(Pág. 31)	<b>72942</b>	(Pág. 124)	<b>72961</b>	(Pág. 121)
Monroe® OESpectrum® Strut		Monroe® OESpectrum® Strut		Monroe® OESpectrum® Strut	
Cadillac — CTS	08-13 D	Toyota — Camry	12-17 TD	Subaru — Impreza	12-14 DI
<b>72923</b>	(Pág. 68)	<b>72943</b>	(Pág. 124)	<b>72962</b>	(Pág. 133)
Monroe® OESpectrum® Strut		Monroe® OESpectrum® Strut		Monroe® OESpectrum® Strut	
Ford — Focus	14-16 DD	Toyota — Camry	12-17 TI	Toyota — Venza	09-12 DD
<b>72924</b>	(Pág. 68)	<b>72944</b>	(Pág. 28)	<b>72963</b>	(Pág. 133)
Monroe® OESpectrum® Strut		Monroe® OESpectrum® Strut		Monroe® OESpectrum® Strut	
Ford — Focus	14-16 DI	BMW — X5	14-18 DD	Toyota — Venza	09-12 DI
<b>72925</b>	(Pág. 85)	<b>72945</b>	(Pág. 99)	<b>72968</b>	(Pág. 96)
Monroe® OESpectrum® Strut		BMW — X6	15-19 DD	Monroe® OESpectrum® Strut	
Honda — Civic	12-15 DD		15-19 DI	Kia — Soul	10-13 DD
<b>72926</b>	(Pág. 85)	<b>72946</b>	(Pág. 99)	<b>72969</b>	(Pág. 96)
Monroe® OESpectrum® Strut		Monroe® OESpectrum® Strut		Monroe® OESpectrum® Strut	
Honda — Civic	12-15 DI	Mazda — 5	12-15 DD	Kia — Soul	10-13 DI
<b>72927</b>	(Pág. 84)	<b>72947</b>	(Pág. 110)	<b>72970</b>	(Pág. 23, 84)
Monroe® OESpectrum® Strut		Monroe® OESpectrum® Strut		Monroe® OESpectrum® Strut	
Honda — Civic	12-15 DD	Mazda — 5	12-15 DI	Honda — Accord	13-17 DD
<b>72928</b>	(Pág. 84)	<b>72948</b>	(Pág. 110)	<b>72971</b>	(Pág. 23, 84)
Monroe® OESpectrum® Strut		Monroe® OESpectrum® Strut		Monroe® OESpectrum® Strut	
Honda — Civic	12-15 DI	Nissan — Sentra	13-19 DD	Honda — Accord	13-17 DI
<b>72929</b>	(Pág. 70)	<b>72949</b>	(Pág. 29, 47)	<b>72974</b>	(Pág. 87)
Monroe® OESpectrum® Strut		Monroe® OESpectrum® Strut		Monroe® OESpectrum® Strut	
Ford — Mustang	15-17 D	Nissan — Sentra	13-19 DI	Honda — Pilot	06-08 DD
<b>72930</b>	(Pág. 92)	<b>72950</b>	(Pág. 92-93)	<b>72975</b>	(Pág. 87)
Monroe® OESpectrum® Strut		Monroe® OESpectrum® Strut		Monroe® OESpectrum® Strut	
Jeep — Cherokee	14-18 DD	Buick — Enclave	13-17 D	Honda — Pilot	06-08 DI
<b>72931</b>	(Pág. 92)	Chevrolet — Traverse	13-17 D	<b>72978</b>	(Pág. 100)
Monroe® OESpectrum® Strut		<b>72951</b>	(Pág. 92-93)	Monroe® OESpectrum® Strut	
Jeep — Cherokee	14-18 DI	Monroe® OESpectrum® Strut		Mazda — CX-5	13-16 DD
<b>72932</b>	(Pág. 49)	Jeep — Compass	11-17 DD	<b>72979</b>	(Pág. 100)
Monroe® OESpectrum® Strut		Jeep — Patriot	11-17 DD	Monroe® OESpectrum® Strut	
Chrysler — 200	15-17 DD	<b>72952</b>	(Pág. 92-93)	Mazda — CX-5	13-16 DI
<b>72933</b>	(Pág. 49)	Monroe® OESpectrum® Strut		<b>72982</b>	(Pág. 87)
Monroe® OESpectrum® Strut		Jeep — Compass	11-17 DI	Monroe® OESpectrum® Strut	
Chrysler — 200	15-17 DI	Jeep — Patriot	11-17 DI	Honda — Odyssey (Mini Van)	13-17 D
<b>72936</b>	(Pág. 108-109)	<b>72953</b>	(Pág. 92-93)	<b>72984</b>	(Pág. 84)
Monroe® OESpectrum® Strut		Monroe® OESpectrum® Strut		Monroe® OESpectrum® Strut	
Nissan — Pathfinder	13-19 DD	Jeep — Compass	11-17 TD	Honda — Accord	13-17 TD
<b>72937</b>	(Pág. 108-109)		11-17 TI		13-17 TI
Monroe® OESpectrum® Strut		Jeep — Patriot	11-17 TD	<b>72985</b>	(Pág. 118)
Nissan — Pathfinder	13-19 DI		11-17 TI	Monroe® OESpectrum® Strut	
<b>72938</b>	(Pág. 99-100)	<b>72955</b>	(Pág. 108)	RAM — Serie Promaster	15-19 DD
Monroe® OESpectrum® Strut		Monroe® OESpectrum® Strut		<b>72986</b>	(Pág. 118)
Mazda — 6	14-17 DD	Nissan — Murano	11-13 DD	Monroe® OESpectrum® Strut	
<b>72939</b>	(Pág. 99-100)	<b>72956</b>	(Pág. 108)	RAM — Serie Promaster	15-19 DI
Monroe® OESpectrum® Strut		Monroe® OESpectrum® Strut		<b>72989</b>	(Pág. 125)
Mazda — 6	14-17 DI	Nissan — Murano	11-13 DI	Monroe® OESpectrum® Strut	
<b>72940</b>	(Pág. 124)	<b>72957</b>	(Pág. 85-86)	Toyota — Corolla	14-18 DD
Monroe® OESpectrum® Strut		Monroe® OESpectrum® Strut		<b>72990</b>	(Pág. 125)
Toyota — Camry	12-17 DD	Honda — CR-V	12-16 TD	Monroe® OESpectrum® Strut	
			12-16 TI	Toyota — Corolla	14-18 DI

Números de parte con P (P-) indican accesorios con la unidad





# PROGRESIVO AMORTIGUADORES

## INDICE PROGRESIVO DE APLICACIONES

Vehículo	Años Pos.	Vehículo	Años Pos.	Vehículo	Años Pos.
<b>72991</b>	(Pág. 125)	<b>73014</b>	(Pág. 129)	<b>73039</b>	(Pág. 122)
Monroe® OESpectrum® Strut		Monroe® OESpectrum® Strut		Monroe® OESpectrum® Strut	
Toyota — Corolla	14-18 TD	Toyota — RAV4	13-18 DI	Subaru — Outback	13-14 TD
	14-18 TI	<b>73015</b>	(Pág. 99)		13-14 TI
<b>72992</b>	(Pág. 124)	Monroe® OESpectrum® Strut		<b>73040</b>	(Pág. 122)
Monroe® OESpectrum® Strut		Mazda — 3	14-18 DD	Monroe® OESpectrum® Strut	
Toyota — Camry	12-17 DD	<b>73016</b>	(Pág. 99)	Subaru — Outback	13-14 DD
<b>72993</b>	(Pág. 124)	Monroe® OESpectrum® Strut		<b>73041</b>	(Pág. 122)
Monroe® OESpectrum® Strut		Mazda — 3	14-18 DI	Monroe® OESpectrum® Strut	
Toyota — Camry	12-17 DI	<b>73017</b>	(Pág. 67)	Subaru — Outback	13-14 DI
<b>72996</b>	(Pág. 77)	Monroe® OESpectrum® Strut		<b>73042</b>	(Pág. 88, 95)
Monroe® OESpectrum® Strut		Ford — Fiesta Ikon	11-15 DD	Monroe® OESpectrum® Strut	
Ford — Transit	06-15 D	<b>73018</b>	(Pág. 67)	Hyundai — Santa Fe	13-18 DD
<b>72997</b>	(Pág. 113, 118)	Monroe® OESpectrum® Strut		Kia — Sorento	14-15 DD
Monroe® OESpectrum® Strut		Ford — Fiesta Ikon	11-15 DI	<b>73043</b>	(Pág. 88, 95)
Nissan — X-Trail	08-14 DD	<b>73019</b>	(Pág. 32, 43)	Monroe® OESpectrum® Strut	
Renault — Koleos	09-16 DD	Monroe® OESpectrum® Strut		Hyundai — Santa Fe	13-18 DI
<b>72998</b>	(Pág. 113, 118)	Chevrolet — Spark	11-15 DD	Kia — Sorento	14-15 DI
Monroe® OESpectrum® Strut		Chevrolet — Spark Classic	16-17 DD	<b>73045</b>	(Pág. 86)
Nissan — X-Trail	08-14 DI	<b>73020</b>	(Pág. 32, 43)	Monroe® OESpectrum® Strut	
Renault — Koleos	09-16 DI	Monroe® OESpectrum® Strut		Honda — CR-V	15-16 DD
<b>72999</b>	(Pág. 114)	Chevrolet — Spark	11-15 DI	<b>73046</b>	(Pág. 86)
Monroe® OESpectrum® Strut		Chevrolet — Spark Classic	16-17 DI	Monroe® OESpectrum® Strut	
Peugeot — 207	06-14 D	<b>73021</b>	(Pág. 93)	Honda — CR-V	15-16 DI
<b>73000</b>	(Pág. 114)	Monroe® OESpectrum® Strut		<b>73047</b>	(Pág. 89)
Monroe® OESpectrum® Strut		Jeep — Renegade	15-18 DD	Monroe® OESpectrum® Strut	
Peugeot — 307	03-10 DD	<b>73022</b>	(Pág. 93)	Hyundai — Santa Fe	07-09 D
<b>73001</b>	(Pág. 114)	Monroe® OESpectrum® Strut		<b>73048</b>	(Pág. 91, 106)
Monroe® OESpectrum® Strut		Jeep — Renegade	15-18 DI	Monroe® OESpectrum® Strut	
Peugeot — 307	03-10 DI	<b>73023</b>	(Pág. 93)	Infiniti — QX56	11-13 D
<b>73004</b>	(Pág. 118)	Monroe® OESpectrum® Strut		<b>73049</b>	(Pág. 131)
Monroe® OESpectrum® Strut		Jeep — Renegade	15-18 TD	Monroe® OESpectrum® Strut	
Renault — Duster	12-19 DI	<b>73024</b>	(Pág. 93)	Toyota — Sienna	11-14 DD
<b>73005</b>	(Pág. 118)	Monroe® OESpectrum® Strut		<b>73050</b>	(Pág. 131)
Monroe® OESpectrum® Strut		Jeep — Renegade	15-18 TI	Monroe® OESpectrum® Strut	
Renault — Duster	12-19 DD	<b>73029</b>	(Pág. 33)	Toyota — Sienna	11-14 DI
<b>73006</b>	(Pág. 118)	Monroe® OESpectrum® Strut		<b>73055</b>	(Pág. 33)
Monroe® OESpectrum® Strut		Chevrolet — Camaro	13-15 TD	Monroe® OESpectrum® Strut	
Renault — Duster	12-19 TD		13-15 TI	Chevrolet — Camaro	16-18 DD
	12-19 TI	<b>73030</b>	(Pág. 33)	<b>73056</b>	(Pág. 33)
<b>73007</b>	(Pág. 119)	Monroe® OESpectrum® Strut		Monroe® OESpectrum® Strut	
Monroe® OESpectrum® Strut		Chevrolet — Camaro	13-15 TD	Chevrolet — Camaro	16-18 DI
Seat — León	06-13 D		13-15 TI	<b>73057</b>	(Pág. 85)
<b>73008</b>	(Pág. 119)	<b>73033</b>	(Pág. 124)	Monroe® OESpectrum® Strut	
Monroe® OESpectrum® Strut		Monroe® OESpectrum® Strut		Honda — CR-V	15-16 DD
Seat — León	06-13 D	Toyota — Camry	12-17 TD	<b>73058</b>	(Pág. 85)
<b>73009</b>	(Pág. 123)	<b>73034</b>	(Pág. 124)	Monroe® OESpectrum® Strut	
Monroe® OESpectrum® Strut		Monroe® OESpectrum® Strut		Honda — CR-V	15-16 DI
Suzuki — Swift	12-17 DD	Toyota — Camry	12-17 TI	<b>73059</b>	(Pág. 64, 98)
<b>73010</b>	(Pág. 123)	<b>73038</b>	(Pág. 31)	Monroe® OESpectrum® Strut	
Monroe® OESpectrum® Strut		Monroe® OESpectrum® Strut		Ford — Edge	15-18 D
Suzuki — Swift	12-17 DI	Cadillac — CTS	14-19 DI	Lincoln — MKX	16-18 D
<b>73013</b>	(Pág. 129)			<b>73060</b>	(Pág. 35)
Monroe® OESpectrum® Strut				Monroe® OESpectrum® Strut	
Toyota — RAV4	13-18 DD			Chevrolet — Cruze	16-17 DD

Números de parte con P (P--) indican accesorios con la unidad



# PROGRESIVO AMORTIGUADORES

## INDICE PROGRESIVO DE APLICACIONES

Vehículo	Años Pos.	Vehículo	Años Pos.	Vehículo	Años Pos.
<b>73061</b>	(Pág. 35)	<b>73086</b>	(Pág. 86)	<b>250001 (Cont.)</b>	(Pág. 39, 47, 53, 93, 107, 109, 112)
Monroe® OESpectrum® Strut		Monroe® OESpectrum® Strut		Monroe® RoadMatic® Amortiguador	
Chevrolet — Cruze	16-17 DI	Honda — Crosstour	12-15 T	Chevrolet — Van 1500 Express, Savana, Modelos G y P	68-72 T
<b>73062</b>	(Pág. 35)	<b>73087</b>	(Pág. 84, 86)	Dina — 1000, 3000	63-66 T
Monroe® OESpectrum® Strut		Monroe® OESpectrum® Strut		Jeep — Pickup S	85-90 T
Chevrolet — Cruze	16-19 DD	Honda — Accord Crosstour	10-11 T		66-84 D
<b>73063</b>	(Pág. 35)	Honda — Crosstour	12-15 T	Nissan — Frontier Pickup	66-84 T
Monroe® OESpectrum® Strut		<b>73088</b>	(Pág. 126)	Nissan — Pickup	98-03 T
Chevrolet — Cruze	16-19 DI	Monroe® OESpectrum® Strut		Nissan — Pickup D-21	95-09 T
<b>73066</b>	(Pág. 96)	Toyota — Highlander	14-19 DD	Nissan — Van Urvan	65-94 T
Monroe® OESpectrum® Strut		<b>73089</b>	(Pág. 126)	<b>250003</b>	(Pág. 38, 116)
Kia — Soul	14-19 DD	Monroe® OESpectrum® Strut		Monroe® RoadMatic® Amortiguador	
<b>73067</b>	(Pág. 96)	Toyota — Highlander	14-19 DI	Chevrolet — Matiz	11-15 TD
Monroe® OESpectrum® Strut		<b>73090</b>	(Pág. 29)		11-15 TI
Kia — Soul	14-19 DI	Monroe® OESpectrum® Strut		Pontiac — Matiz	06-10 TD
<b>73068</b>	(Pág. 120)	Buick — LaCrosse	17-19 DD		06-10 TI
Monroe® OESpectrum® Strut		<b>73091</b>	(Pág. 29)	<b>250004</b>	(Pág. 66-67)
Subaru — Forester	14-17 DD	Monroe® OESpectrum® Strut		Monroe® RoadMatic® Amortiguador	
<b>73069</b>	(Pág. 120)	Buick — LaCrosse	17-19 DI	Ford — Explorer	91-06 T
Monroe® OESpectrum® Strut		<b>73097</b>	(Pág. 85)	<b>250005</b>	(Pág. 66-67, 76)
Subaru — Forester	14-17 DI	Monroe® OESpectrum® Strut		Monroe® RoadMatic® Amortiguador	
<b>73070</b>	(Pág. 120, 123)	Honda — CR-V	17-19 DD	Ford — Explorer	91-94 D
Monroe® OESpectrum® Strut		<b>73098</b>	(Pág. 85)	Ford — Ranger	90-97 D
Subaru — Crosstrek	16-17 DD	Monroe® OESpectrum® Strut		<b>250006</b>	(Pág. 67, 76)
Subaru — XV Crosstrek	13-15 DD	Honda — CR-V	17-19 DI	Monroe® RoadMatic® Amortiguador	
<b>73071</b>	(Pág. 120, 123)	<b>90005C1</b>	(Pág. 66)	Ford — Explorer	95-06 D
Monroe® OESpectrum® Strut		Monroe® Kit de Conversión		Ford — Ranger	98-11 D
Subaru — Crosstrek	16-17 DI	Ford — Expedition	97-02 D	<b>250007</b>	(Pág. 76)
Subaru — XV Crosstrek	13-15 DI	Ford — Expedition	97-02 T	Monroe® RoadMatic® Amortiguador	
<b>73072</b>	(Pág. 89, 94)	<b>90005C2</b>	(Pág. 66)	Ford — Ranger	83-11 T
Monroe® OESpectrum® Strut		Monroe® Kit de Conversión		<b>250008</b>	(Pág. 66-67)
Hyundai — Sonata	15-19 DD	Ford — Expedition	97-02 D	Monroe® RoadMatic® Amortiguador	
<b>73073</b>	(Pág. 89, 94)	Ford — Expedition	97-02 T	Ford — Explorer	95-06 D
Monroe® OESpectrum® Strut		<b>90015C</b>	(Pág. 66)	<b>250009</b>	(Pág. 110)
Hyundai — Sonata	15-19 DI	Monroe® Kit de Instalación		Monroe® RoadMatic® Amortiguador	
<b>73079</b>	(Pág. 122)	Ford — Expedition	03-06 D	Nissan — Sentra	07-12 TD
Monroe® OESpectrum® Strut			03-06 T		07-12 TD
Subaru — Legacy	13-14 DD	<b>90020C</b>	(Pág. 51, 54)		07-12 TI
<b>73080</b>	(Pág. 122)	Monroe® Kit de Conversión			07-12 TI
Monroe® OESpectrum® Strut		Chrysler — Town & Country	12-16 T	<b>250010</b>	(Pág. 68-69)
Subaru — Legacy	13-14 DI	Dodge — Caravan y Grand Caravan	10-15 T	Monroe® RoadMatic® Amortiguador	
<b>73082</b>	(Pág. 84)	<b>90022C</b>	(Pág. 97, 123)	Ford — Focus	12-18 TD
Monroe® OESpectrum® Strut		Monroe® Kit de Conversión			12-18 TI
Honda — Accord Crosstour	10-15 D	Lexus — GX470	03-09 T	<b>250011</b>	(Pág. 24, 133-136)
<b>73083</b>	(Pág. 86)	Toyota — 4 Runner	03-09 T	Monroe® RoadMatic® Amortiguador	
Monroe® OESpectrum® Strut		<b>90029C</b>	(Pág. 55-56)	Audi — A3	05-13 T
Honda — Crosstour	12-15 D	Monroe® Kit de Conversión			05-13 T
<b>73084</b>	(Pág. 120)	Dodge — Charger	06-10 T	Volkswagen — Bora	05-11 T
Monroe® OESpectrum® Strut		<b>250000</b>	(Pág. 69)		05-11 T
Subaru — Forester	14-17 TD	Monroe® RoadMatic® Amortiguador		Volkswagen — CC	09-17 T
	14-17 TI	Ford — Focus	02-11 TD		09-17 T
<b>73085</b>	(Pág. 123)		02-11 TI	Volkswagen — Golf SportWagen	10-13 T
Monroe® OESpectrum® Strut		<b>250001</b>	(Pág. 39, 47, 53, 93, 107, 109, 112)		10-13 T
Subaru — XV Crosstrek	13-15 TD	Monroe® RoadMatic® Amortiguador		Volkswagen — GTi	06-14 T
	13-15 TI	Chevrolet — Pickup C y R	63-72 T		06-14 T
				Volkswagen — Passat	06-10 T
					06-10 T

Números de parte con P (P--) indican accesorios con la unidad



# PROGRESIVO AMORTIGUADORES

## INDICE PROGRESIVO DE APLICACIONES

Vehículo	Años Pos.	Vehículo	Años Pos.	Vehículo	Años Pos.
<b>250011</b> (Cont.)	(Pág. 24, 133-136)	<b>250089</b>	(Pág. 134, 137)	<b>250290</b>	(Pág. 52, 54-55)
Monroe® RoadMatic® Amortiguador		Monroe® RoadMatic® Amortiguador		Monroe® RoadMatic® Amortiguador	
Volkswagen — Passat CC	09-12 T	Volkswagen — Brasília	73-82 T	Chrysler — Town & Country	95-07 T
	09-12 T	Volkswagen — Safari	73-80 T	Chrysler — Voyager y Grand	95-07 T
<b>250012</b>	(Pág. 36, 116)	Volkswagen — Sedán	53-04 T	Voyager	
Monroe® RoadMatic® Amortiguador			53-72 D	Dodge — Caravan y Grand	95-07 T
Chevrolet — Equinox	05-17 TD	<b>250132</b>	(Pág. 31-32, 34, 38, 43, 63, 106, 113, 116)	Caravan	
	05-17 TI	Monroe® RoadMatic® Amortiguador		<b>250300</b>	(Pág. 32, 43, 79, 83)
Pontiac — Torrent	06-09 TD	Cadillac — Seville	76-79 D	Monroe® RoadMatic® Amortiguador	
	06-09 TI	Chevrolet — Blazer	83-93 D	Chevrolet — Blazer	94-05 D
<b>250013</b>	(Pág. 58, 93)	Chevrolet — Chevelle	73-77 D	Chevrolet — S-10	94-05 D
Monroe® RoadMatic® Amortiguador		Chevrolet — Chevy Nova	75-79 D	GMC — Envoy	00-01 D
Dodge — Nitro	07-12 TD	Chevrolet — Monte Carlo	73-88 D	GMC — Sonoma 2WD	94-05 D
	07-12 TI	Chevrolet — S-10	82-93 D	<b>250302</b>	(Pág. 66, 71-72)
Jeep — Liberty	02-12 TD	Ford — Aerostar (Mini) Van	86-97 D	Monroe® RoadMatic® Amortiguador	
	02-12 TI	Nissan — Datsun	64-69 D	Ford — Expedition	97-02 D
<b>250014</b>	(Pág. 37, 91, 107, 109)	Oldsmobile — Cutlass	68-88 D	Ford — Pickup Serie F-100, F-150,	97-04 D
Monroe® RoadMatic® Amortiguador		Oldsmobile — Cutlass Supreme	78-87 D	Lobo	
Chevrolet — Luv Pickup	97-06 T	Pontiac — Grand Prix	73-87 D	Ford — Pickup Serie F-250	97-99 D
	81-83 T	Pontiac — Le Mans	73-83 D		(Pág. 71)
Isuzu — Amigo	89-95 T	<b>250147</b>	(Pág. 34, 35, 38)	<b>250303</b>	
Isuzu — Pickup	89-95 T	Monroe® RoadMatic® Amortiguador		Monroe® RoadMatic® Amortiguador	
Nissan — Frontier Pickup	98-04 T	Chevrolet — Chevy, Chevy Joy,	93-12 T	Ford — Pickup Serie F-100, F-150,	97-03 T
Nissan — Pickup 720	83-86 T	Pop y Swing		Lobo	
<b>250015</b>	(Pág. 38)	Chevrolet — Corsa	01-08 TD	<b>250322</b>	(Pág. 66)
Monroe® RoadMatic® Amortiguador			01-08 TI	Monroe® RoadMatic® Amortiguador	
Chevrolet — Malibu	04-07 TD	Chevrolet — Monza	93-12 T	Ford — Expedition	97-02 T
	04-07 TI	<b>250157</b>	(Pág. 64)	<b>250410</b>	(Pág. 106)
<b>250016</b>	(Pág. 37, 107, 109)	Monroe® RoadMatic® Amortiguador		Monroe® RoadMatic® Amortiguador	
Monroe® RoadMatic® Amortiguador		Ford — EcoSport	04-12 T	Nissan — Altima	02-06 TD
Chevrolet — Luv Pickup	97-06 D	<b>250158</b>	(Pág. 67)		02-06 TI
	81-83 D	Monroe® RoadMatic® Amortiguador		<b>250538</b>	(Pág. 134, 137)
Nissan — Frontier Pickup	98-04 D	Ford — Fiesta	03-10 T	Monroe® RoadMatic® Amortiguador	
Nissan — Pickup	95-97 D	<b>250186</b>	(Pág. 32-33, 43, 79, 83)	Volkswagen — Brasília	73-82 D
Nissan — Pickup 720	83-86 D	Monroe® RoadMatic® Amortiguador		Volkswagen — Safari	73-80 D
<b>250017</b>	(Pág. 59, 60)	Chevrolet — Blazer	83-05 T	Volkswagen — Sedán	73-04 D
Monroe® RoadMatic® Amortiguador		Chevrolet — S-10	82-05 T	<b>250794</b>	(Pág. 32, 115)
Dodge — Pickup Ram 1500	94-01 D	GMC — Envoy	98-01 T	Monroe® RoadMatic® Amortiguador	
Dodge — Pickup Ram 2500	94-02 D	GMC — Sonoma 2WD	82-05 T	Chevrolet — Aveo	04-18 TD
Dodge — Pickup Ram 3500	94-02 D	<b>250194</b>	(Pág. 33, 43, 79, 83)		04-18 TI
<b>250018</b>	(Pág. 59, 60)	Monroe® RoadMatic® Amortiguador		Pontiac — G3	06-09 TD
Monroe® RoadMatic® Amortiguador		Chevrolet — Blazer	83-05 D		06-09 TI
Dodge — Pickup Ram 1500	94-01 T	Chevrolet — S-10	83-05 D	<b>250984</b>	(Pág. 24, 119-120, 133, 135-136)
Dodge — Pickup Ram 2500	94-02 T	GMC — Envoy	98-01 D	Monroe® RoadMatic® Amortiguador	
Dodge — Pickup Ram 3500	94-02 T	GMC — Sonoma 2WD	82-05 D	Audi — A3	98-04 T
<b>250019</b>	(Pág. 129-130)	<b>250197</b>	(Pág. 109, 118)	Seat — León	01-13 T
Monroe® RoadMatic® Amortiguador		Monroe® RoadMatic® Amortiguador		Seat — Toledo	01-08 T
Toyota — RAV4	06-18 TD	Nissan — Platina	02-10 T	Volkswagen — Beetle	98-11 T
	06-18 TI	Renault — Clio	01-10 T	Volkswagen — Golf A4	99-07 T
<b>250020</b>	(Pág. 29, 47, 78)	<b>250224</b>	(Pág. 39, 44, 47-48, 81-82)	Volkswagen — Jetta A4	99-10 T
Monroe® RoadMatic® Amortiguador		Monroe® RoadMatic® Amortiguador		Volkswagen — Jetta Clasico	11-15 T
Buick — Enclave	08-17 T	Chevrolet — Pickup C y R	87-00 D	<b>251022</b>	(Pág. 49)
Chevrolet — Traverse	09-17 T	Chevrolet — Suburban	92-99 D	Monroe® RoadMatic® Amortiguador	
GMC — Acadia	07-16 T	Chevrolet — Van 1500 Express,	96-02 D	Chrysler — Atos	00-12 TD
		Savana, Modelos G y P			00-12 TD
<b>250021</b>	(Pág. 53, 95)	Chevrolet — Van Cargo Van	97-00 D		00-12 TI
Monroe® RoadMatic® Amortiguador		GMC — Pickup Series C, R, K y V	87-02 D	<b>400000</b>	(Pág. 35)
Dodge — Attitude	06-11 TD			Monroe® RoadMatic® Strut	
	06-11 TI			Chevrolet — Corsa	01-08 DD

Números de parte con P (P--) indican accesorios con la unidad



# PROGRESIVO AMORTIGUADORES

## INDICE PROGRESIVO DE APLICACIONES

Vehículo	Años Pos.	Vehículo	Años Pos.	Vehículo	Años Pos.
<b>400001</b>	(Pág. 35)	<b>400014</b>	(Pág. 136)	<b>400023 (Cont.)</b>	(Pág. 49, 51, 53)
Monroe® RoadMatic® Strut		Monroe® RoadMatic® Strut		Monroe® RoadMatic® Strut	
Chevrolet — Corsa	01-08 DI	Volkswagen — Pointer Pickup	98-10 T	Chrysler — Sebring	07-10 TD
<b>400002</b>	(Pág. 38, 116)	<b>400015</b>	(Pág. 129-130)		07-10 TD
Monroe® RoadMatic® Strut		Monroe® RoadMatic® Strut			07-10 TI
Chevrolet — Matiz	11-15 DD	Toyota — RAV4	06-12 DD	Dodge — Avenger	07-10 TI
Pontiac — Matiz	06-10 DD	<b>400016</b>	(Pág. 129-130)		07-14 TD
<b>400003</b>	(Pág. 38, 116)	Monroe® RoadMatic® Strut			07-14 TD
Monroe® RoadMatic® Strut		Toyota — RAV4	06-12 DI		07-14 TI
Chevrolet — Matiz	11-15 DI	<b>400017</b>	(Pág. 109, 118)	<b>400025</b>	(Pág. 64)
Pontiac — Matiz	06-10 DI	Monroe® RoadMatic® Strut		Monroe® RoadMatic® Strut	
<b>400004</b>	(Pág. 34, 38)	Nissan — Platina	02-10 D	Ford — EcoSport	04-12 D
Monroe® RoadMatic® Strut		Renault — Clio	01-10 D	<b>400026</b>	(Pág. 33-34, 36, 116)
Chevrolet — Chevy Pickup	93-05 D	<b>400018</b>	(Pág. 29, 47, 78)	Monroe® RoadMatic® Strut	
Chevrolet — Chevy, Chevy Joy, Pop y Swing	93-12 D	Monroe® RoadMatic® Strut		Chevrolet — Captiva	08-11 DD
Chevrolet — Meriva	03-08 DD	Buick — Enclave	08-12 D		08-11 DD
	03-08 DI	Chevrolet — Traverse	09-12 D	Chevrolet — Captiva Sport	12-15 DD
Chevrolet — Monza	93-12 D	GMC — Acadia	07-12 D		12-15 DD
<b>400005</b>	(Pág. 136)	<b>400019</b>	(Pág. 38, 115)	Chevrolet — Equinox	07-17 DD
Monroe® RoadMatic® 0		Monroe® RoadMatic® 0			07-17 DD
Volkswagen — Pointer	98-09 T	Chevrolet — Malibu	08-09 DD	Pontiac — Torrent	07-09 DD
<b>400007</b>	(Pág. 58, 93)	Pontiac — G6	05-10 DD		07-09 DD
Monroe® RoadMatic® Strut		<b>400020</b>	(Pág. 38, 115)	<b>400027</b>	(Pág. 33-34, 36, 116)
Dodge — Nitro	07-12 DD	Monroe® RoadMatic® Strut		Monroe® RoadMatic® Strut	
	07-12 DD	Chevrolet — Malibu	08-09 DI	Chevrolet — Captiva	08-11 DI
	07-12 DI	Pontiac — G6	05-10 DI		08-11 DI
	07-12 DI	<b>400021</b>	(Pág. 119, 133-136)	Chevrolet — Captiva Sport	12-15 DI
Jeep — Liberty	02-12 DD	Monroe® RoadMatic® Strut			12-15 DI
	02-12 DD	Seat — Altea	10-12 D	Chevrolet — Equinox	07-17 DI
	02-12 DI		05-06 D		07-17 DI
	02-12 DI	Volkswagen — Beetle	12-18 D	Pontiac — Torrent	07-09 DI
<b>400008</b>	(Pág. 110)	Volkswagen — Bora	05-11 D		07-09 DI
Monroe® RoadMatic® Strut		Volkswagen — CC	09-17 D	<b>400028</b>	(Pág. 67)
Nissan — Sentra	07-12 DD	Volkswagen — Eos	07-16 D	Monroe® RoadMatic® Strut	
<b>400009</b>	(Pág. 110)	Volkswagen — Golf SportWagen	10-13 D	Ford — Fiesta	03-10 D
Monroe® RoadMatic® Strut		Volkswagen — Jetta	11-18 D	<b>400029</b>	(Pág. 119, 136)
Nissan — Sentra	07-12 DI	Volkswagen — Passat	2012 D	Monroe® RoadMatic® Strut	
<b>400010</b>	(Pág. 49, 51, 53)		06-10 D	Seat — Cordoba	03-09 D
Monroe® RoadMatic® Strut		Volkswagen — Passat CC	09-12 D	Seat — Ibiza	03-09 D
Chrysler — 200	11-14 DD	<b>400022</b>	(Pág. 52, 54-55)	Volkswagen — Lupo	03-09 D
Chrysler — Cirrus	07-10 DD	Monroe® RoadMatic® Strut		Volkswagen — Polo	03-08 D
Chrysler — Sebring	07-10 DD	Chrysler — Town & Country	01-07 D	<b>400030</b>	(Pág. 53, 95)
Dodge — Avenger	07-14 DD	Chrysler — Voyager y Grand Voyager	01-07 D	Monroe® RoadMatic® Strut	
<b>400011</b>	(Pág. 49, 51, 53)	Dodge — Caravan y Grand Caravan	01-07 D	Dodge — Attitude	06-11 DD
Monroe® RoadMatic® Strut		<b>400023</b>	(Pág. 49, 51, 53)		06-11 DD
Chrysler — 200	11-14 DI	Monroe® RoadMatic® Strut		<b>400031</b>	(Pág. 53, 95)
Chrysler — Cirrus	07-10 DI	Chrysler — 200	11-14 TD	Monroe® RoadMatic® Strut	
Chrysler — Sebring	07-10 DI		11-14 TD	Dodge — Attitude	06-11 DI
Dodge — Avenger	07-14 DI		11-14 TI		06-11 DI
<b>400012</b>	(Pág. 69)		11-14 TI	<b>400032</b>	(Pág. 24, 134-137)
Monroe® RoadMatic® Strut		Chrysler — Cirrus	07-10 TD	Monroe® RoadMatic® Strut	
Ford — Focus	12-13 DD		07-10 TD	Audi — A3	05-13 D
<b>400013</b>	(Pág. 69)		07-10 TI	Volkswagen — Bora	05-11 D
Monroe® RoadMatic® Strut			07-10 TI	Volkswagen — GTi	06-14 D
Ford — Focus	12-13 DI		07-10 TI	Volkswagen — Passat	06-10 D
				Volkswagen — Tiguan	09-17 D

Números de parte con P (P--) indican accesorios con la unidad



# PROGRESIVO AMORTIGUADORES

## INDICE PROGRESIVO DE APLICACIONES

Vehículo	Años Pos.	Vehículo	Años Pos.	Vehículo	Años Pos.
<b>400033</b>	(Pág. 54, 92-93)	<b>400525 (Cont.)</b>	(Pág. 24, 119-120, 133, 135-136)	<b>550018</b>	(Pág. 64)
Monroe® RoadMatic® Strut		Monroe® RoadMatic® Strut		Monroe® Gas-Magnum® Servicio Severo	
Dodge — Caliber	07-12 TD	Volkswagen — Jetta Clasico	11-15 D	Amortiguador	
Jeep — Compass	07-10 TD	<b>400871</b>	(Pág. 111-112)	Ford — Crown Victoria	03-11 T
Jeep — Patriot	07-10 TI	Monroe® RoadMatic® Strut			(Pág. 64)
Jeep — Patriot	07-10 TD	Nissan — Tsubame	93-04 DD	<b>550055</b>	
Jeep — Patriot	07-10 TI	Nissan — Tsuru	92-17 DD	Monroe® Gas-Magnum® Servicio Severo	
		<b>400872</b>	(Pág. 111-112)	Amortiguador	
<b>400034</b>	(Pág. 54, 92-93)	Monroe® RoadMatic® Strut		Ford — Crown Victoria	03-11 T
Monroe® RoadMatic® Strut		Nissan — Tsubame	93-04 DI		(Pág. 58-59, 117)
Dodge — Caliber	07-12 DD	Nissan — Tsuru	92-17 DI	<b>550060</b>	
Jeep — Compass	07-10 DD	<b>400873</b>	(Pág. 112)	Monroe® Gas-Magnum® Servicio Severo	
Jeep — Patriot	07-10 DD	Monroe® RoadMatic® Strut		Amortiguador	
		Nissan — Tsuru	92-17 TD	Dodge — Pickup Ram 1500	09-18 T
<b>400035</b>	(Pág. 54, 92-93)	<b>400874</b>	(Pág. 112)	RAM — Serie 1500	11-18 T
Monroe® RoadMatic® Strut		Monroe® RoadMatic® Strut			(Pág. 72)
Dodge — Caliber	07-12 DI	Nissan — Tsuru	92-17 TI	<b>550062</b>	
Jeep — Compass	07-10 DI	<b>400888</b>	(Pág. 136)	Monroe® Gas-Magnum® Servicio Severo	
Jeep — Patriot	07-10 DI	Monroe® RoadMatic® Strut		Amortiguador	
		Volkswagen — Pointer	98-09 D	Ford — Pickup Serie F-100, F-150,	09-13 T
<b>400105</b>	(Pág. 110)	Volkswagen — Pointer Pickup	98-10 D	Lobo	
Monroe® RoadMatic® Strut		<b>400933</b>	(Pág. 135-136)		(Pág. 72, 99)
Nissan — Sentra	02-06 DD	Monroe® RoadMatic® Strut		Monroe® Gas-Magnum® Servicio Severo	
		Volkswagen — Golf A3	93-98 D	Amortiguador	
<b>400106</b>	(Pág. 110)	Volkswagen — Jetta A3	93-98 D	Ford — Pickup Serie F-100, F-150,	04-08 T
Monroe® RoadMatic® Strut		<b>400964</b>	(Pág. 52, 55)	Lobo	
Nissan — Sentra	02-06 DI	Monroe® RoadMatic® Strut		Lincoln — Pickup Mark LT	06-08 T
		Chrysler — Town & Country	95-00 D		(Pág. 73-74)
<b>400265</b>	(Pág. 135-136)	Chrysler — Voyager y Grand	95-00 D	<b>550066</b>	
Monroe® RoadMatic® Strut		Voyager		Monroe® Gas-Magnum® Servicio Severo	
Volkswagen — Golf A2	85-91 T	Dodge — Caravan y Grand	95-00 D	Amortiguador	
Volkswagen — Golf A3	93-98 T	Caravan		Ford — Pickup Serie F-250	17-19 T
Volkswagen — Jetta A2	85-91 T	<b>401044</b>	(Pág. 69)	Ford — Pickup Serie F-350	17-19 T
Volkswagen — Jetta A3	93-98 T	Monroe® RoadMatic® Strut			(Pág. 40-41, 79-80)
		Ford — Focus	00-05 DD	<b>552001</b>	
<b>400295</b>	(Pág. 32, 115)	<b>401045</b>	(Pág. 69)	Monroe® Gas-Magnum® Servicio Severo	
Monroe® RoadMatic® Strut		Monroe® RoadMatic® Strut		Monotubo Amortiguador	
Chevrolet — Aveo	04-18 DD	Ford — Focus	00-05 DI	Chevrolet — Pickup Silverado	07-18 T
Pontiac — G3	06-09 DD	<b>401052</b>	(Pág. 49)	GMC — Pickup Sierra 1500	07-18 T
		Monroe® RoadMatic® Strut			(Pág. 64)
<b>400296</b>	(Pág. 32, 115)	Chrysler — Atos	00-12 DD	<b>553001</b>	
Monroe® RoadMatic® Strut			00-12 DD	Monroe® Gas-Magnum® Servicio Severo	
Chevrolet — Aveo	04-18 DI	<b>401053</b>	(Pág. 49)	Amortiguador	
Pontiac — G3	06-09 DI	Monroe® RoadMatic® Strut		Ford — Crown Victoria	03-11 D
		Chrysler — Atos	00-12 DI		(Pág. 63)
<b>400312</b>	(Pág. 110-111, 119)	<b>550010</b>	(Pág. 64)	<b>553002</b>	
Monroe® RoadMatic® Strut		Monroe® Gas-Magnum® Servicio Severo		Monroe® Gas-Magnum® Servicio Severo	
Nissan — Sentra	00-06 TD	Amortiguador		Amortiguador	
Renault — Scala	11-13 TD	Ford — Crown Victoria	83-02 D	Dodge — Van Sprinter	03-06 D
			(Pág. 64)		(Pág. 63, 102)
		<b>550011</b>	(Pág. 64)	<b>553003</b>	
<b>400426</b>	(Pág. 106)	Monroe® Gas-Magnum® Servicio Severo		Monroe® Gas-Magnum® Servicio Severo	
Monroe® RoadMatic® Strut		Amortiguador		Amortiguador	
Nissan — Altima	02-06 DD	Ford — Crown Victoria	83-02 D	Dodge — Van Sprinter	07-09 D
			(Pág. 64)	Mercedes Benz — Van Sprinter	10-18 D
<b>400427</b>	(Pág. 106)	<b>550018</b>	(Pág. 64)		(Pág. 77)
Monroe® RoadMatic® Strut		Monroe® Gas-Magnum® Servicio Severo		<b>553005</b>	
Nissan — Altima	02-06 DI	Amortiguador		Monroe® Gas-Magnum® Servicio Severo	
		Ford — Crown Victoria	83-02 T	Amortiguador	
<b>400525</b>	(Pág. 24, 119-120, 133, 135-136)			Ford — Transit	15-19 D
Monroe® RoadMatic® Strut					(Pág. 77)
Audi — A3	98-04 D	<b>553006</b>		<b>553007</b>	
Seat — León	01-08 D	Monroe® Gas-Magnum® Servicio Severo		Monroe® Gas-Magnum® Servicio Severo	
Seat — Toledo	01-08 D	Amortiguador		Amortiguador	
Volkswagen — Beetle	98-11 D	Ford — Crown Victoria	83-02 T	Ford — Transit	15-19 D
Volkswagen — Golf A4	99-07 D				(Pág. 117)
Volkswagen — Jetta A4	99-10 D			Monroe® Gas-Magnum® Servicio Severo Strut	
				RAM — Serie Promaster	14-19 D

Números de parte con P (P--) indican accesorios con la unidad



# PROGRESIVO AMORTIGUADORES

## INDICE PROGRESIVO DE APLICACIONES

Vehículo	Años Pos.	Vehículo	Años Pos.	Vehículo	Años Pos.
<b>553023</b>	(Pág. 36-37)	<b>801052</b>	(Pág. 134)	<b>801567</b>	(Pág. 111)
Monroe® Gas-Magnum® Servicio Severo Strut		Monroe® Monro-Matic Plus® Strut		Monroe® Monro-Matic Plus® Strut	
Chevrolet — Impala	12-13 TD	Volkswagen — Crossfox	05-17 D	Nissan — Sentra	00-01 DI
	12-13 TI	<b>801265</b>	(Pág. 134-136)	<b>801572</b>	(Pág. 52, 54-55)
Chevrolet — Impala Limited	14-16 TD	Monroe® Monro-Matic Plus® Strut		Monroe® Monro-Matic Plus® Strut	
	14-16 TI	Volkswagen — Cabrio	95-02 T	Chrysler — Town & Country	01-07 D
<b>553024</b>	(Pág. 66)	Volkswagen — Golf A2	85-91 T	Chrysler — Voyager y Grand Voyager	01-07 D
Monroe® Gas-Magnum® Servicio Severo Strut		Volkswagen — Golf A3	93-98 T	Dodge — Caravan y Grand Caravan	01-07 D
Ford — Explorer	12-19 DD	Volkswagen — Jetta A2	85-91 T		
<b>553025</b>	(Pág. 66)	Volkswagen — Jetta A3	93-98 T	<b>801580</b>	(Pág. 58)
Monroe® Gas-Magnum® Servicio Severo Strut		<b>801281</b>	(Pág. 34, 116)	Monroe® Monro-Matic Plus® Strut	
Ford — Explorer	12-19 DI	Monroe® Monro-Matic Plus® Strut		Dodge — Neón	00-05 D
<b>801001</b>	(Pág. 70)	Chevrolet — Cavalier	95-05 T	<b>801654</b>	(Pág. 132)
Monroe® Monro-Matic Plus® Strut		Pontiac — Sunfire	95-05 T	Monroe® Monro-Matic Plus® Strut	
Ford — Ikon	98-08 D	<b>801311</b>	(Pág. 49-51, 63)	Toyota — Tercel	95-99 DD
<b>801002</b>	(Pág. 70)	Monroe® Monro-Matic Plus® Strut		<b>801655</b>	(Pág. 132)
Monroe® Monro-Matic Plus® Strut		Chrysler — Cirrus	99-06 T	Monroe® Monro-Matic Plus® Strut	
Ford — Ikon	98-08 T	Chrysler — Sebring	01-06 T	Toyota — Tercel	95-99 DI
<b>801003</b>	(Pág. 64)	Dodge — Stratus	99-06 T	<b>801661</b>	(Pág. 29, 36-37, 48, 114, 116)
Monroe® Monro-Matic Plus® Strut		<b>801340</b>	(Pág. 85)	Monroe® Monro-Matic Plus® Strut	
Ford — Courier Pickup	00-12 D	Monroe® Monro-Matic Plus® Strut		Buick — Century	97-05 DD
<b>801006</b>	(Pág. 70)	Honda — Civic	01-05 TD		
Monroe® Monro-Matic Plus® Strut			01-05 TI	Chevrolet — Impala	97-05 DI
Ford — KA	01-08 D	<b>801371</b>	(Pág. 123, 126, 132)		00-13 DI
<b>801012</b>	(Pág. 70)	Monroe® Monro-Matic Plus® Strut		Chevrolet — Venture (Mini Van) AWD	97-05 D
Monroe® Monro-Matic Plus® Strut		Toyota — FJ Cruiser	07-13 D	Oldsmobile — Silhouette	97-05 D
Ford — KA	01-08 T	Toyota — Tacoma	05-15 D	Pontiac — Grand Prix	97-03 D
<b>801017</b>	(Pág. 109, 118)	<b>801372</b>	(Pág. 23, 84)	<b>801662</b>	(Pág. 29, 36-37, 116)
Monroe® Monro-Matic Plus® Strut		Monroe® Monro-Matic Plus® Strut		Monroe® Monro-Matic Plus® Strut	
Nissan — Platina	02-10 D	Acura — TL	04-08 T	Buick — Century	97-05 TD
Renault — Clio	01-10 D	Honda — Accord	03-07 T		97-05 TI
<b>801018</b>	(Pág. 67)	<b>801380</b>	(Pág. 86)	Chevrolet — Impala	00-13 TD
Monroe® Monro-Matic Plus® Strut		Monroe® Monro-Matic Plus® Strut			00-13 TI
Ford — Fiesta	98-05 D	Honda — CR-V	02-06 TD	Pontiac — Grand Prix	97-03 T
<b>801019</b>	(Pág. 67)		02-06 TI	<b>801678</b>	(Pág. 125)
Monroe® Monro-Matic Plus® Strut		<b>801426</b>	(Pág. 106)	Monroe® Monro-Matic Plus® Strut	
Ford — Fiesta	98-05 D	Monroe® Monro-Matic Plus® Strut		Toyota — Camry	97-01 DD
<b>801023</b>	(Pág. 49)	Nissan — Altima	02-06 DD	<b>801853</b>	(Pág. 135-136)
Monroe® Monro-Matic Plus® Strut		<b>801427</b>	(Pág. 106)	Monroe® Monro-Matic Plus® Strut	
Chevrolet — Zafira	00-07 DD	Monroe® Monro-Matic Plus® Strut		Volkswagen — Golf A2	85-91 D
<b>801024</b>	(Pág. 49)	Nissan — Altima	02-06 DI	Volkswagen — Jetta A2	85-91 D
Monroe® Monro-Matic Plus® Strut		<b>801504</b>	(Pág. 69)	<b>801933</b>	(Pág. 135-136)
Chevrolet — Zafira	00-07 DI	Monroe® Monro-Matic Plus® Strut		Monroe® Monro-Matic Plus® Strut	
<b>801025</b>	(Pág. 64)	Ford — Focus	00-05 DD	Volkswagen — Golf A3	93-98 D
Monroe® Monro-Matic Plus® Strut		<b>801505</b>	(Pág. 69)	Volkswagen — Jetta A3	93-98 D
Ford — EcoSport	04-12 D	Monroe® Monro-Matic Plus® Strut		<b>801962</b>	(Pág. 71)
<b>801028</b>	(Pág. 67)	Ford — Focus	00-05 DI	Monroe® Monro-Matic Plus® Strut	
Monroe® Monro-Matic Plus® Strut		<b>801565</b>	(Pág. 49-51, 63)	Ford — Mustang	94-04 D
Ford — Fiesta	03-10 D	Monroe® Monro-Matic Plus® Strut		<b>801964</b>	(Pág. 52, 55)
<b>801050</b>	(Pág. 46)	Chrysler — Cirrus	99-06 D	Monroe® Monro-Matic Plus® Strut	
Monroe® Monro-Matic Plus® Strut		Chrysler — Sebring	01-06 D	Chrysler — Town & Country	95-00 D
Chevrolet — Tornado	04-10 DD	Dodge — Stratus	99-06 D	Chrysler — Voyager y Grand Voyager	95-00 D
<b>801051</b>	(Pág. 46)	<b>801566</b>	(Pág. 111)	Dodge — Caravan y Grand Caravan	95-00 D
Monroe® Monro-Matic Plus® Strut		Monroe® Monro-Matic Plus® Strut			
Chevrolet — Tornado	04-10 DI	Nissan — Sentra	00-01 DD		

Números de parte con P (P--) indican accesorios con la unidad



# PROGRESIVO AMORTIGUADORES

## INDICE PROGRESIVO DE APLICACIONES

Vehículo	Años Pos.	Vehículo	Años Pos.	Vehículo	Años Pos.
<b>801968</b>	(Pág. 107, 111)	<b>802212</b>	(Pág. 97, 127)	<b>901904 (Cont.)</b>	(Pág. 135-136)
Monroe® Monro-Matic Plus® Strut		Monroe® Monro-Matic Plus® Strut		Monroe® Strut-Mate® Bases de Amortiguador	
Nissan — Lucino 95-99 DD		Lexus — RX330 04-06 DI		Volkswagen — Passat 93-97 D	
Nissan — Sentra 96-99 DD		Lexus — RX350 07-09 DI			
<b>801969</b>	(Pág. 107, 111)	Lexus — RX400H 06-07 DI		<b>901908</b>	(Pág. 50-53, 55, 57-58, 62, 114-115)
Monroe® Monro-Matic Plus® Strut		Toyota — Highlander 04-07 DI		Monroe® Strut-Mate® Bases de Amortiguador	
Nissan — Lucino 95-99 DI		<b>802240</b>	(Pág. 108)	Chrysler — Dynasty 88-93 D	
Nissan — Sentra 96-99 DI		Monroe® Monro-Matic Plus® Strut		Chrysler — LeBaron 89-95 D	
<b>801979</b>	(Pág. 125)	Nissan — Maxima 04-08 DD		Chrysler — New Yorker y Fifth Avenue	
Monroe® Monro-Matic Plus® Strut		<b>802241</b>	(Pág. 108)	Chrysler — Town & Country 90-95 D	
Toyota — Camry 95-96 DD		Monroe® Monro-Matic Plus® Strut		Chrysler — Voyager y Grand Voyager	
<b>802105</b>	(Pág. 110)	Nissan — Maxima 04-08 DI		Dodge — 600 86-88 D	
Monroe® Monro-Matic Plus® Strut		<b>802248</b>	(Pág. 49, 55-56)	Dodge — Aries 86-89 D	
Nissan — Sentra 02-06 DD		Monroe® Monro-Matic Plus® Strut		Dodge — Caravan y Grand Caravan	
<b>802106</b>	(Pág. 110)	Chrysler — 300, 300C y 300M 05-10 D		Dodge — Daytona 86-93 D	
Monroe® Monro-Matic Plus® Strut		Dodge — Challenger 08-10 D		Dodge — Lancer 86-89 D	
Nissan — Sentra 02-06 DI		Dodge — Charger 06-10 D		Dodge — Shadow 89-94 D	
<b>802116</b>	(Pág. 117, 128)	<b>802263</b>	(Pág. 99)	Dodge — Spirit 89-95 D	
Monroe® Monro-Matic Plus® Strut		Monroe® Monro-Matic Plus® Strut		Plymouth — Acclaim 89-95 D	
Pontiac — Vibe 03-08 DD		Mazda — 3 04-13 DD		Plymouth — Caravelle 86-88 D	
Toyota — Matrix 03-08 DD		<b>802264</b>	(Pág. 99)	Plymouth — Reliant 86-89 D	
<b>802130</b>	(Pág. 51)	Monroe® Monro-Matic Plus® Strut		Plymouth — Sundance 87-94 D	
Monroe® Monro-Matic Plus® Strut		Mazda — 3 04-13 DI		<b>901921</b>	(Pág. 30, 37-38, 113, 116)
Chrysler — Pacifica 04-08 D		<b>802267</b>	(Pág. 108)	Monroe® Strut-Mate® Bases de Amortiguador	
<b>802143</b>	(Pág. 86)	Monroe® Monro-Matic Plus® Strut		Buick — Regal 88-96 D	
Monroe® Monro-Matic Plus® Strut		Nissan — Murano 03-08 DD		Chevrolet — Lumina 97-01 DD	
Honda — CR-V 02-06 DD		<b>802268</b>	(Pág. 108)	95-96 D	
<b>802144</b>	(Pág. 86)	Monroe® Monro-Matic Plus® Strut		Chevrolet — Monte Carlo 97-99 DD	
Monroe® Monro-Matic Plus® Strut		Nissan — Murano 03-08 DI		97-99 DI	
Honda — CR-V 02-06 DI		<b>802275</b>	(Pág. 129-130)	Oldsmobile — Cutlass Supreme 88-97 D	
<b>802199</b>	(Pág. 38, 115)	Monroe® Monro-Matic Plus® Strut		Pontiac — Grand Prix 88-96 D	
Monroe® Monro-Matic Plus® Strut		Toyota — RAV4 06-12 DD		<b>901925</b>	(Pág. 67, 70-71, 102, 103)
Chevrolet — Malibu 08-09 DD		<b>802401</b>	(Pág. 92, 93)	Monroe® Strut-Mate® Bases de Amortiguador	
Pontiac — G6 05-10 DD		Monroe® Monro-Matic Plus® Strut		Ford — Fairline y Fairline 500 78-83 D	
<b>802200</b>	(Pág. 38, 115)	Jeep — Compass 07-10 TD		Ford — Mustang 85-04 D	
Monroe® Monro-Matic Plus® Strut		07-10 TI		Mercury — Capri y Capri II 79-86 D	
Chevrolet — Malibu 08-09 DI		Jeep — Patriot 07-10 TD		Mercury — Zephyr 78-83 D	
Pontiac — G6 05-10 DI		07-10 TI		<b>901929</b>	(Pág. 32, 34-35)
<b>802207</b>	(Pág. 97, 124-125, 132)	<b>802491</b>	(Pág. 86)	Monroe® Strut-Mate® Bases de Amortiguador	
Monroe® Monro-Matic Plus® Strut		Monroe® Monro-Matic Plus® Strut		Chevrolet — Beretta 87-91 D	
Lexus — ES330 04-06 TD		Honda — CR-V 07-11 DD		Chevrolet — Cavalier 92-94 D	
Toyota — Avalon 05-06 TD		<b>802492</b>	(Pág. 86)	Chevrolet — Corsica 87-91 D	
Toyota — Camry 04-06 TD		Monroe® Monro-Matic Plus® Strut		<b>901934</b>	(Pág. 29, 34, 37, 113-114)
Toyota — Solara 04-06 TD		Honda — CR-V 07-11 DI		Monroe® Strut-Mate® Bases de Amortiguador	
<b>802208</b>	(Pág. 97, 124-125, 132)	<b>802497</b>	(Pág. 86)	Buick — Century 82-96 D	
Monroe® Monro-Matic Plus® Strut		Monroe® Monro-Matic Plus® Strut		Chevrolet — Celebrity 82-90 D	
Lexus — ES330 04-06 TI		Honda — CR-V 07-11 TD		Chevrolet — Citation 82-84 D	
Toyota — Avalon 05-06 TI		07-11 TI		Chevrolet — Lumina 89-96 D	
Toyota — Camry 04-06 TI		<b>802896</b>	(Pág. 58)	Oldsmobile — Cutlass Ciera 82-96 D	
Toyota — Solara 04-06 TI		Monroe® Monro-Matic Plus® Strut		Oldsmobile — Eurosport 85-90 D	
<b>802211</b>	(Pág. 97, 127)	Dodge — Journey 11-19 TD		Oldsmobile — Silhouette 90-96 D	
Monroe® Monro-Matic Plus® Strut		11-19 TI		<b>901940®</b>	(Pág. 23, 49-51, 63, 84-87)
Lexus — RX330 04-06 DD		<b>901904</b>	(Pág. 135-136)	Monroe® Strut-Mate® Bases de Amortiguador	
Lexus — RX350 07-09 DD		Monroe® Strut-Mate® Bases de Amortiguador		Acura — Integra 94-01 D	
Lexus — RX400H 06-07 DD		Volkswagen — Golf A2 85-91 D		94-01 T	
Toyota — Highlander 04-07 DD		Volkswagen — Jetta A2 85-91 D			
		Volkswagen — Jetta A3 93-98 D			

Números de parte con P (P--) indican accesorios con la unidad



# PROGRESIVO AMORTIGUADORES

## INDICE PROGRESIVO DE APLICACIONES

Vehículo	Años Pos.	Vehículo	Años Pos.	Vehículo	Años Pos.
<b>901940® (Cont.)</b>	(Pág. 23, 49-51, 63, 84-87)	<b>901953</b>	(Pág. 113, 115)	<b>902018</b>	(Pág. 88, 89)
Monroe® Strut-Mate® Bases de Amortiguador		Monroe® Strut-Mate® Bases de Amortiguador		Monroe® Strut-Mate® Bases de Amortiguador	
Acura — TL	09-14 DD	Oldsmobile — Eighty-Eight (88)	91-99 T	Hyundai — Elantra	11-16 DD
	09-14 DI		87-89 T		11-16 DI
	09-14 TD	Pontiac — Bonneville	91-99 T	Hyundai — Veloster	12-15 D
	09-14 TI				
	04-08 D	<b>901961</b>	(Pág. 84)	<b>902022</b>	(Pág. 105, 107)
	04-05 T	Monroe® Strut-Mate® Bases de Amortiguador		Monroe® Strut-Mate® Bases de Amortiguador	
Acura — TSX	09-14 DD	Honda — Accord	86-97 T	Nissan — Altima	13-18 DD
	09-14 DI				13-18 DI
	09-14 TD	<b>901965</b>	(Pág. 25, 28)	Nissan — Maxima	16-18 D
	09-14 TI	Monroe® Strut-Mate® Bases de Amortiguador			
	04-08 D	BMW — 325i	95-97 TD	<b>902023</b>	(Pág. 107, 110)
	04-08 T	BMW — Z3	96-02 T	Monroe® Strut-Mate® Aislador de Resorte	
Chrysler — Cirrus	01-06 T			Nissan — Juke	11-15 D
	96-06 D	<b>901966</b>	(Pág. 134-136)	Nissan — Rogue	08-14 D
Chrysler — Sebring	01-06 D	Monroe® Strut-Mate® Bases de Amortiguador			
	01-06 T	Volkswagen — Cabrio	95-02 T	<b>902024</b>	(Pág. 124)
Chrysler — Stratus	95-97 D	Volkswagen — Cabriolet	85-93 T	Monroe® Strut-Mate® Bases de Amortiguador	
Dodge — Stratus	99-06 T	Volkswagen — Caribe	77-87 T	Toyota — Avalon	13-15 T
	95-06 D	Volkswagen — Derby	93-98 T	Toyota — Camry	12-17 TD
Honda — Accord	98-12 T	Volkswagen — Golf A2	85-91 T		12-17 TI
	86-12 D	Volkswagen — Golf A3	93-98 T	<b>902025</b>	(Pág. 124)
Honda — Civic	01-05 TD	Volkswagen — Jetta A2	85-91 T	Monroe® Strut-Mate® Aislador de Resorte	
	01-05 TI	Volkswagen — Jetta A3	93-98 T	Toyota — Avalon	13-15 DD
	92-00 D				
	92-00 T	<b>901970</b>	(Pág. 77, 102)	<b>902026</b>	(Pág. 124)
Honda — Crosstour	12-15 D	Monroe® Strut-Mate® Bases de Amortiguador		Monroe® Strut-Mate® Aislador de Resorte	
	12-15 T	Ford — Thunderbird	89-97 D	Toyota — Avalon	13-15 DI
Honda — CR-V	02-14 TD	Mercury — Cougar	89-97 D		
	02-14 TI			<b>902027</b>	(Pág. 124)
	97-01 D	<b>901983</b>	(Pág. 132)	Monroe® Strut-Mate® Aislador de Resorte	
	97-01 T	Monroe® Strut-Mate® Bases de Amortiguador		Toyota — Avalon	13-15 TD
Honda — Element	03-11 TD	Toyota — Tercel	95-99 DD		
	03-11 TI		95-99 DI	<b>902028</b>	(Pág. 124)
Honda — Odyssey (Mini Van)	95-98 D	<b>901989</b>	(Pág. 112)	Monroe® Strut-Mate® Aislador de Resorte	
	95-98 T	Monroe® Strut-Mate® Bases de Amortiguador		Toyota — Avalon	13-15 TI
Honda — Ridgeline	06-14 TD	Nissan — Tsuru	92-17 TD	<b>902033</b>	(Pág. 130-131)
	06-14 TI		92-17 TI	Monroe® Strut-Mate® Bases de Amortiguador	
				Toyota — Sienna	11-14 DD
<b>901944®</b>	(Pág. 129)	<b>902006</b>	(Pág. 120, 122)		11-14 DI
Monroe® Strut-Mate® Bases de Amortiguador		Monroe® Strut-Mate® Asiento de Resorte		<b>902034</b>	(Pág. 23)
Toyota — Previa (Van)	90-97 DD	Subaru — B9 Tribeca	06-07 D	Monroe® Strut-Mate® Plato de Montaje	
	90-97 DI	Subaru — Legacy	00-04 D	Acura — TL	09-14 D
<b>901951</b>	(Pág. 29-30, 32, 34-35, 37, 113-114, 116)	Subaru — Outback	10-14 D		
Monroe® Strut-Mate® Bases de Amortiguador		Subaru — Tribeca	08-14 D	<b>902035</b>	(Pág. 31, 40-41, 43-46, 79-80, 83)
Buick — Century	85-96 T	<b>902007</b>	(Pág. 120-123)	Monroe® Strut-Mate® Bases de Amortiguador	
Cadillac — Cimarron	83-88 T	Monroe® Strut-Mate® Asiento de Resorte		Cadillac — Escalade	15-16 D
Chevrolet — Beretta	87-94 T	Subaru — Forester	06-17 D	Chevrolet — Pickup Silverado	14-18 D
Chevrolet — Cavalier	84-94 T	Subaru — Impreza	02-07 D	Chevrolet — Suburban	15-18 D
Chevrolet — Celebrity	85-90 T	Subaru — XV Crosstrek	13-15 D	Chevrolet — Tahoe	15-18 D
Chevrolet — Corsica	87-96 T			GMC — Pickup Sierra 1500	14-18 D
Chevrolet — Lumina	89-96 T	<b>902008</b>	(Pág. 120-123)		
Oldsmobile — Calais	85-91 TD	Monroe® Strut-Mate® Aislador de Resorte		<b>902036</b>	(Pág. 53)
	85-91 TI	Subaru — Forester	06-17 D	Monroe® Strut-Mate® Bases de Amortiguador	
Oldsmobile — Cutlass Ciera	82-96 T	Subaru — Impreza	02-07 D	Dodge — Attitude	12-14 DD
Oldsmobile — Eurosport	85-90 T	Subaru — XV Crosstrek	13-15 D		12-14 DI
Oldsmobile — Silhouette	90-96 T			<b>902037</b>	(Pág. 89, 95)
Pontiac — Grand Am	96-98 T	<b>902011</b>	(Pág. 84)	Monroe® Strut-Mate® Bases de Amortiguador	
	85-94 T	Monroe® Strut-Mate® Bases de Amortiguador		Hyundai — Santa Fe	10-12 D
		Honda — Civic	12-15 DD	Kia — Sorento	11-13 DD
			12-15 DI		11-13 DI

Números de parte con P (P--) indican accesorios con la unidad





# PROGRESIVO AMORTIGUADORES

## INDICE PROGRESIVO DE APLICACIONES

Vehículo	Años Pos.	Vehículo	Años Pos.	Vehículo	Años Pos.
<b>902038</b> Monroe® Strut-Mate® Bases de Amortiguador Kia — Forte	(Pág. 94) 10-13 DD 10-13 DI	<b>902065</b> Monroe® Strut-Mate® Bases de Amortiguador Toyota — Venza	(Pág. 133) 09-12 TI	<b>902906</b> Monroe® Strut-Mate® Bases de Amortiguador Seat — Alhambra	(Pág. 119, 134-137) 02-08 D
<b>902039</b> Monroe® Strut-Mate® Bases de Amortiguador Kia — Sorento	(Pág. 95-96) 03-09 D	<b>902066</b> Monroe® Strut-Mate® Bases de Amortiguador Subaru — Forester	(Pág. 121) 09-13 TD 09-13 TI	Volkswagen — Cabrio Volkswagen — Derby Volkswagen — Golf A3 Volkswagen — Passat Volkswagen — Sharan	95-02 D 93-98 D 93-98 D 93-97 D 02-08 D
<b>902050</b> Monroe® Strut-Mate® Plato de Montaje Acura — TL	(Pág. 23) 04-08 D	Subaru — Impreza	12-14 T 08-14 TD 08-14 TI	<b>902910</b> Monroe® Strut-Mate® Bases de Amortiguador Ford — Windstar (Mini Van)	(Pág. 78) 94-03 D
<b>902051</b> Monroe® Strut-Mate® Bases de Amortiguador Cadillac — SRX	(Pág. 31) 10-15 D	<b>902069</b> Monroe® Strut-Mate® Aislador de Resorte Hyundai — Santa Fe Kia — Sorento	(Pág. 89, 95) 10-12 D 11-13 D	<b>902923</b> Monroe® Strut-Mate® Bases de Amortiguador Chrysler — Cirrus	(Pág. 50-51, 62, 103-104) 01-05 TD 01-05 TI
<b>902053</b> Monroe® Strut-Mate® Bases de Amortiguador Dodge — Durango Jeep — Grand Cherokee	(Pág. 57, 93) 11-16 D 11-15 D	<b>902070</b> Monroe® Strut-Mate® Aislador de Resorte Hyundai — Santa Fe Kia — Sorento	(Pág. 89, 95) 10-12 D 11-13 D	Chrysler — Sebring Dodge — Sebring	01-05 TI 01-05 TD 01-05 TI
<b>902054</b> Monroe® Strut-Mate® Bases de Amortiguador Dodge — Journey	(Pág. 58) 11-19 TD 11-19 TI	<b>902071</b> Monroe® Strut-Mate® Aislador de Resorte Mitsubishi — Lancer Mitsubishi — Outlander	(Pág. 104-105) 02-07 D 03-04 D	Dodge — Stratus Mitsubishi — Eclipse	01-05 TD 01-05 TI 06-12 T 00-05 TD
<b>902055</b> Monroe® Strut-Mate® Plato de Montaje Honda — Accord	(Pág. 84) 16-17 T 13-15 DD 13-15 DI	<b>902117</b> Monroe® Strut-Mate® Bases de Amortiguador Hyundai — Elantra	(Pág. 88) 07-11 TD 07-11 TI	Mitsubishi — Galant	99-11 TD 99-11 TI
<b>902056</b> Monroe® Strut-Mate® Bases de Amortiguador Honda — Accord	(Pág. 84) 13-15 DD 13-15 DI	<b>902123</b> Monroe® Strut-Mate® Bases de Amortiguador Ford — Mondeo	(Pág. 70) 01-07 D	<b>902924</b> Monroe® Strut-Mate® Bases de Amortiguador Saab — 9-2x	(Pág. 119, 121-122) 05-06 DD 05-06 DI
<b>902057</b> Monroe® Strut-Mate® Plato de Montaje Honda — CR-V	(Pág. 85-86) 12-16 T	<b>902125</b> Monroe® Strut-Mate® Bases de Amortiguador Peugeot — 306	(Pág. 114) 97-03 D	Subaru — Forester Subaru — Impreza	06-08 DD 06-08 DI 04-07 D 02-03 DD 02-03 DI
<b>902058</b> Monroe® Strut-Mate® Plato de Montaje Kia — Amanti	(Pág. 94) 04-06 D	<b>902126</b> Monroe® Strut-Mate® Bases de Amortiguador Renault — Megane, Megane II	(Pág. 118) 04-10 D	Subaru — Legacy	10-14 DD 10-14 DI
<b>902059</b> Monroe® Strut-Mate® Plato de Montaje Mitsubishi — Galant	(Pág. 104) 04-11 T	<b>902127</b> Monroe® Strut-Mate® Bases de Amortiguador Nissan — Aprio Renault — Duster	(Pág. 106, 118-119) 07-10 D 12-19 DD 12-19 DI	Subaru — Outback	10-14 DD 10-14 DI
<b>902060</b> Monroe® Strut-Mate® Bases de Amortiguador Nissan — Sentra	(Pág. 110) 13-19 DD	Renault — Logan Renault — Stepway	15-18 D 10-14 D	<b>902926</b> Monroe® Strut-Mate® Bases de Amortiguador Toyota — Camry	(Pág. 125) 92-94 DD 92-94 DI
<b>902061</b> Monroe® Strut-Mate® Bases de Amortiguador Nissan — Sentra	(Pág. 110) 13-19 DI	<b>902129</b> Monroe® Strut-Mate® Bases de Amortiguador Volkswagen — Van Eurovan	(Pág. 137) 06-09 D	<b>902938</b> Monroe® Strut-Mate® Bases de Amortiguador Nissan — Lucino	(Pág. 107, 111-112) 95-99 DD 95-99 DI
<b>902062</b> Monroe® Strut-Mate® Plato de Montaje Toyota — Corolla	(Pág. 125) 14-16 TD	<b>902901</b> Monroe® Strut-Mate® Bases de Amortiguador Toyota — Corolla	(Pág. 126) 88-02 TD 88-02 TI	Nissan — Sentra Nissan — Tsubame	96-99 DD 96-99 DI 93-04 DD 93-04 DI
<b>902063</b> Monroe® Strut-Mate® Plato de Montaje Toyota — Corolla	(Pág. 125) 14-16 TI	<b>902905</b> Monroe® Strut-Mate® Bases de Amortiguador BMW — 325i	(Pág. 25, 28, 119) 95-97 DD 95-97 DI	Nissan — Tsuru	92-17 DD 92-17 DI
<b>902064</b> Monroe® Strut-Mate® Bases de Amortiguador Toyota — Venza	(Pág. 133) 09-12 TD	BMW — Z3 Seat — Cordoba Seat — Ibiza	96-02 D 99-02 D 01-02 D	<b>902945</b> Monroe® Strut-Mate® Bases de Amortiguador Chrysler — Town & Country Chrysler — Voyager y Grand Voyager	(Pág. 52, 55) 95-00 D 95-00 D

Números de parte con P (P--) indican accesorios con la unidad



# PROGRESIVO AMORTIGUADORES

## INDICE PROGRESIVO DE APLICACIONES

Vehículo	Años Pos.	Vehículo	Años Pos.	Vehículo	Años Pos.
<b>902945</b> (Cont.)	(Pág. 52, 55)	<b>902978</b> (Cont.)	(Pág. 105, 107, 111)	<b>903918</b>	(Pág. 24-28)
Monroe® Strut-Mate® Bases de Amortiguador Dodge — Caravan y Grand Caravan	95-00 D	Monroe® Strut-Mate® Bases de Amortiguador Nissan — Lucino	95-99 TD 95-99 TI	Monroe® Strut-Mate® Bases de Amortiguador BMW — 128	08-13 DD 08-13 DI
<b>902949</b> ®	(Pág. 34, 116)	Nissan — Sentra	96-99 TD 96-99 TI	BMW — 135	08-13 DD 08-13 DI
Monroe® Strut-Mate® Bases de Amortiguador Chevrolet — Cavalier	95-05 T	<b>902981</b>	(Pág. 106)	BMW — 323i	99-00 DD 99-00 DI
Pontiac — Sunfire	95-05 T	Monroe® Strut-Mate® Bases de Amortiguador Nissan — Altima	93-01 TD 93-01 TI	BMW — 325i	01-13 DD 01-13 DI
<b>902953</b>	(Pág. 64, 70, 102)	<b>902984</b>	(Pág. 96)	BMW — 328i (E90)	07-13 DD 07-13 DI
Monroe® Strut-Mate® Bases de Amortiguador Ford — Contour	95-00 D	Monroe® Strut-Mate® Bases de Amortiguador Kia — Spectra	04-09 DD 04-09 DI	BMW — 330i	01-07 DD 01-07 DI
Ford — Mystique	97-00 D	Kia — Spectra 5	05-09 DD 05-09 DI	BMW — 335i (E90, 92, 93)	07-15 DD 07-15 DI
Mercury — Cougar	99-02 D	<b>902986</b>	(Pág. 132)	BMW — 525i	01-03 DD 01-03 DI
Mercury — Mystique	95-97 D	Monroe® Strut-Mate® Bases de Amortiguador Toyota — Tercel	95-99 TD 95-99 TI	BMW — 525iT	01-03 DD 01-03 DI
<b>902968</b>	(Pág. 29, 36-38, 113)	<b>902989</b>	(Pág. 103, 108, 110)	BMW — 528i	95-03 DD 95-03 DI
Monroe® Strut-Mate® Bases de Amortiguador Buick — Century	97-05 TD	Monroe® Strut-Mate® Bases de Amortiguador Mercury — Villager	99-02 D 93-98 DD 93-98 DI	BMW — 528iT	95-00 DD 95-00 DI
Chevrolet — Impala	12-13 T 00-13 TD 00-05 TI	Nissan — Maxima	89-94 D	BMW — 530i	01-03 DD 01-03 DI
Chevrolet — Impala Limited	14-16 T 14-16 TD	Nissan — Quest (Mini Van)	93-03 DD 93-03 DI	BMW — X3	04-11 DD 04-11 DI
Chevrolet — Lumina	97-01 TD 95-96 T	<b>903903</b>	(Pág. 124-125, 131)	<b>903928</b>	(Pág. 69)
Chevrolet — Monte Carlo	97-99 TI	Monroe® Strut-Mate® Bases de Amortiguador Toyota — Avalon	04-05 DI	Monroe® Strut-Mate® Bases de Amortiguador Ford — Focus	00-07 DD 00-07 DI
Oldsmobile — Intrigue	98-02 TI	Toyota — Camry	97-01 DD	<b>903932</b>	(Pág. 30, 116)
<b>902969</b>	(Pág. 29, 36-38, 113, 116)	Toyota — Sienna	98-03 DD	Monroe® Strut-Mate® Bases de Amortiguador Cadillac — Catera	97-01 D
Monroe® Strut-Mate® Bases de Amortiguador Buick — Century	97-05 TI	<b>903904</b>	(Pág. 97, 124-125, 132)	Pontiac — GTO	04-06 D
Chevrolet — Impala	12-13 T 00-13 TI 00-05 TD	Monroe® Strut-Mate® Bases de Amortiguador Lexus — ES330	04-06 TD 04-06 TI	<b>903935</b>	(Pág. 96)
Chevrolet — Impala Limited	14-16 T 14-16 TI	Toyota — Avalon	04-05 TD	Monroe® Strut-Mate® Bases de Amortiguador Kia — Spectra	04-09 TI
Chevrolet — Lumina	97-01 TI 95-96 T	Toyota — Camry	04-05 TI 97-06 TD	Kia — Spectra 5	05-09 TI
Chevrolet — Monte Carlo	97-99 TD	Toyota — Solara	04-06 TD 04-06 TI	<b>903936</b>	(Pág. 96)
Oldsmobile — Intrigue	98-02 TD	<b>903906</b>	(Pág. 124-125, 131)	Monroe® Strut-Mate® Bases de Amortiguador Kia — Spectra	04-09 TD
Pontiac — Grand Prix	97-03 T	Monroe® Strut-Mate® Bases de Amortiguador Toyota — Avalon	04-05 DD	Kia — Spectra 5	05-09 TD
<b>902973</b> ®	(Pág. 29, 36-37, 47-48, 113-116)	Toyota — Camry	97-06 TD 97-06 TI	<b>903938</b>	(Pág. 52)
Monroe® Strut-Mate® Bases de Amortiguador Buick — Century	97-05 DD 97-05 DI	Toyota — Solara	04-06 TD 04-06 TI	Monroe® Strut-Mate® Bases de Amortiguador Chrysler — Verna	00-06 DD 00-06 DI
Chevrolet — Impala	12-13 D 00-13 DD 00-13 DI	<b>903911</b>	(Pág. 90-91, 108)	<b>903939</b>	(Pág. 52)
Chevrolet — Impala Limited	14-16 D 14-16 DD 14-16 DI	Monroe® Strut-Mate® Bases de Amortiguador Infiniti — G20	99-02 D 99-02 T 91-96 D	Monroe® Strut-Mate® Bases de Amortiguador Chrysler — Verna	00-06 TD 00-06 TI
Chevrolet — Uplander	05-09 D	Infiniti — I30, I35	96-99 T	<b>903950</b>	(Pág. 110-111)
Chevrolet — Venture (Mini Van) AWD	97-05 D	Infiniti — M45	03-04 T	Monroe® Strut-Mate® Bases de Amortiguador Nissan — Sentra	00-06 DD 00-06 DI
Oldsmobile — Intrigue	98-02 DD 98-02 DI	Infiniti — Q45	90-93 T		
Oldsmobile — Silhouette	97-05 D	Nissan — Maxima	95-99 TD 95-99 TI		
Pontiac — Aztek AWD	01-05 D				
Pontiac — Grand Prix	97-03 D				
<b>902978</b>	(Pág. 105, 107, 111)				
Monroe® Strut-Mate® Bases de Amortiguador Nissan — 300ZX	90-96 T				

Números de parte con P (P--) indican accesorios con la unidad



# PROGRESIVO AMORTIGADORES

## INDICE PROGRESIVO DE APLICACIONES

Vehículo	Años Pos.	Vehículo	Años Pos.	Vehículo	Años Pos.
<b>903954</b> Monroe® Strut-Mate® Bases de Amortiguador Nissan — Pathfinder	(Pág. 109) 02-03 D 96-01 DD 96-01 DI	<b>904910 (Cont.)</b> Monroe® Strut-Mate® Bases de Amortiguador Volkswagen — Crossfox Volkswagen — Golf A4 Volkswagen — Jetta A4 Volkswagen — Jetta Clasico Volkswagen — Lupo Volkswagen — Polo Volkswagen — SportVan	(Pág. 24, 119-120, 133-137) 05-17 T 99-07 T 99-10 T 11-15 T 03-09 T 03-08 T 06-10 T	<b>904940</b> Monroe® Strut-Mate® Aislador de Resorte Chevrolet — Cavalier Pontiac — Sunfire	(Pág. 34, 116) 95-05 D 95-05 D
<b>903959</b> Monroe® Strut-Mate® Bases de Amortiguador Saab — 9-5	(Pág. 119) 99-06 D	<b>904912</b> Monroe® Strut-Mate® Bases de Amortiguador Chevrolet — Cavalier Chevrolet — Corsica Pontiac — Grand Am Pontiac — Sunfire	(Pág. 32, 34-35, 116) 95-99 D 95-96 D 96-98 D 95-05 D	<b>904941</b> Monroe® Strut-Mate® Aislador de Resorte Buick — Century Chevrolet — Impala Chevrolet — Impala Limited Pontiac — Grand Prix	(Pág. 29, 36-37, 116) 97-05 T 00-13 T 14-16 T 97-03 T
<b>903978</b> Monroe® Strut-Mate® Asiento de Resorte Volvo — C70 Volvo — S60 Volvo — S80 Volvo — V70	(Pág. 138) 98-04 D 01-09 D 99-06 D 00-07 D	<b>904913</b> Monroe® Strut-Mate® Bases de Amortiguador Ford — Escort	(Pág. 65) 97-03 D	<b>904943</b> Monroe® Strut-Mate® Aislador de Resorte Buick — Century Chevrolet — Impala Chevrolet — Impala Limited Chevrolet — Uplander Chevrolet — Venture (Mini Van) AWD Oldsmobile — Silhouette Pontiac — Aztek AWD	(Pág. 29, 36-37, 47-48, 114-115) 97-05 D 00-13 D 14-16 D 05-09 D 97-05 D 97-05 D 01-05 D
<b>903986</b> Monroe® Strut-Mate® Bases de Amortiguador Subaru — Impreza	(Pág. 122) 02-03 TD	<b>904916</b> Monroe® Strut-Mate® Asiento y Aislador de Resorte Chrysler — Dynasty Chrysler — LeBaron Chrysler — New Yorker y Fifth Avenue Chrysler — Town & Country Chrysler — Voyager y Grand Voyager Dodge — 600 Dodge — Aries Dodge — Caravan y Grand Caravan Dodge — Daytona Dodge — Lancer Dodge — Shadow Dodge — Spirit Plymouth — Acclaim Plymouth — Caravelle Plymouth — Reliant Plymouth — Sundance	(Pág. 122) 02-03 TI (Pág. 50-53, 55, 57-58, 62, 114-115) 88-93 D 89-95 D 86-93 D 90-95 D 86-94 D 86-88 D 86-89 D 86-95 D 86-93 D 86-89 D 89-94 D 89-95 D 89-95 D 86-88 D 86-89 D 87-94 D	<b>904953</b> Monroe® Strut-Mate® Aislador de Resorte Toyota — Avalon Toyota — Camry Toyota — Highlander Toyota — Venza	(Pág. 124-125, 127, 133) 97-05 D 01-05 D
<b>903987</b> Monroe® Strut-Mate® Bases de Amortiguador Subaru — Impreza	(Pág. 130) 02-03 TI	<b>904932</b> Monroe® Strut-Mate® Bases de Amortiguador Chevrolet — Tracker	(Pág. 46) 98-04 D	<b>904957</b> Monroe® Strut-Mate® Bases de Amortiguador Chrysler — Cirrus Chrysler — Sebring Dodge — Sebring Dodge — Stratus Hyundai — Santa Fe Mitsubishi — Eclipse Mitsubishi — Galant	(Pág. 50, 51, 62, 89, 104) 01-05 DD 01-05 DI 01-05 DD 01-05 DI 01-05 DD 01-06 DD 01-06 DI 00-05 DD 00-05 DI 99-03 DD 99-03 DI
<b>903995</b> Monroe® Strut-Mate® Bases de Amortiguador Toyota — RAV4	(Pág. 130) 96-05 DD 96-05 DI	<b>904934</b> Monroe® Strut-Mate® Bases de Amortiguador Subaru — Legacy Subaru — Outback	(Pág. 122) 00-04 T 05-09 TD 05-09 TI	<b>904961</b> Monroe® Strut-Mate® Bases de Amortiguador Ford — Fiesta Ford — Ikon Ford — KA	(Pág. 67, 70) 98-05 D 98-08 D 01-08 D
<b>904900</b> Monroe® Strut-Mate® Bases de Amortiguador Toyota — 4 Runner Toyota — Tacoma	(Pág. 123, 132) 96-02 D 95-04 DD 95-04 DI	<b>904935</b> Monroe® Strut-Mate® Bases de Amortiguador Pontiac — Vibe Toyota — Matrix	(Pág. 117, 128) 03-08 DD 03-08 DI 03-08 DD 03-08 DI	<b>904962</b> Monroe® Strut-Mate® Asiento y Aislador de Resorte Chevrolet — Camaro Pontiac — Firebird	(Pág. 33, 115) 93-02 D 93-02 D
<b>904903</b> Monroe® Strut-Mate® Bases de Amortiguador Volvo — C70 Volvo — S60 Volvo — S80 Volvo — V70	(Pág. 138) 98-04 D 01-09 D 99-06 D 00-07 D	<b>904938</b> Monroe® Strut-Mate® Bases de Amortiguador Ford — Escape Mercury — Mariner	(Pág. 65, 102) 01-12 DD 01-12 DI 05-11 DD 05-11 DI	<b>904965</b> Monroe® Strut-Mate® Bases de Amortiguador Audi — A4 Audi — A6	(Pág. 24) 97-16 T 05-11 T
<b>904905</b> Monroe® Strut-Mate® Bases de Amortiguador Audi — A3 Audi — TT Seat — León Seat — Toledo Volkswagen — Beetle Volkswagen — Golf A4 Volkswagen — Jetta A4 Volkswagen — Jetta Clasico Volkswagen — Vento	(Pág. 24, 119-120, 133, 135-137) 98-04 D 00-06 D 01-08 D 01-08 D 98-11 D 99-07 D 99-10 D 11-15 D 13-17 D				
<b>904909</b> Monroe® Strut-Mate® Bases de Amortiguador Audi — A6 Volkswagen — Passat	(Pág. 24, 136) 99-04 T 01-05 T				
<b>904910</b> Monroe® Strut-Mate® Bases de Amortiguador Audi — A3 Audi — TT Seat — Cordoba Seat — Ibiza Seat — León Seat — Toledo Volkswagen — Beetle	(Pág. 24, 119-120, 133-137) 98-04 T 00-06 T 99-09 T 01-09 T 01-08 T 01-08 T 98-11 T				

Números de parte con P (P--) indican accesorios con la unidad



# PROGRESIVO AMORTIGUADORES

## INDICE PROGRESIVO DE APLICACIONES

Vehículo	Años Pos.	Vehículo	Años Pos.	Vehículo	Años Pos.
<b>904966</b>	(Pág. 25, 26)	<b>904989 (Cont.)</b>	(Pág. 97, 125, 127, 131-132)	<b>905907 (Cont.)</b>	(Pág. 36, 115)
Monroe® Strut-Mate® Bases de Amortiguador		Monroe® Strut-Mate® Bases de Amortiguador		Monroe® Strut-Mate® Bases de Amortiguador	
BMW — 323i	99-00 TD	Toyota — Highlander	04-07 DD	Pontiac — G5	07-09 D
	99-00 TI		04-07 DI		(Pág. 38, 115)
BMW — 325i	01-05 TD	Toyota — Sienna	04-10 DD	<b>905908</b>	
	01-05 TI		04-10 DI	Monroe® Strut-Mate® Bases de Amortiguador	
BMW — 330i	01-07 TD		04-06 D	Chevrolet — Malibu	04-12 DD
	01-07 TI	Toyota — Solara	04-06 DD	Pontiac — G6	05-10 DD
			04-06 DI		(Pág. 38, 115)
<b>904967</b>	(Pág. 136)	<b>904990</b>	(Pág. 116-117, 120, 125-126, 128-129)	<b>905909</b>	
Monroe® Strut-Mate® Bases de Amortiguador		Monroe® Strut-Mate® Bases de Amortiguador		Monroe® Strut-Mate® Bases de Amortiguador	
Volkswagen — Pointer	98-09 D	Pontiac — Vibe	03-10 TD	Chevrolet — Malibu	04-12 DI
			03-10 TI	Pontiac — G6	05-10 DI
<b>904968</b>	(Pág. 46, 79)	Scion — tC	05-10 TD		(Pág. 32, 40-41, 44-46, 79-80, 83)
Monroe® Strut-Mate® Bases de Amortiguador			05-10 TI	<b>905910</b>	
Chevrolet — Trailblazer	02-09 D	Toyota — Corolla	03-18 TD	Monroe® Strut-Mate® Bases de Amortiguador	
GMC — Envoy	02-09 D		03-18 TI	Chevrolet — Avalanche	07-13 D
	(Pág. 71-72, 98-99)	Toyota — Matrix	03-13 TD	Chevrolet — Pickup Silverado	07-13 D
<b>904970</b>			03-13 TI	Chevrolet — Suburban	07-14 D
Monroe® Strut-Mate® Bases de Amortiguador		Toyota — Prius	04-09 TD	Chevrolet — Tahoe	07-14 D
Ford — Pickup Serie F-100, F-150, Lobo	04-08 D		04-09 TI	GMC — Pickup Sierra 1500	07-13 D
Lincoln — Pickup Mark LT	06-08 D			GMC — Yukon	07-14 D
	(Pág. 77, 97)	<b>904992</b>	(Pág. 24, 136, 137)		(Pág. 51-52, 54-55)
<b>904972</b>		Monroe® Strut-Mate® Bases de Amortiguador		<b>905911</b>	
Monroe® Strut-Mate® Bases de Amortiguador		Audi — A4	97-16 D	Monroe® Strut-Mate® Bases de Amortiguador	
Ford — Thunderbird	02-05 D	Audi — A6	12-18 D	Chrysler — Pacifica	04-08 D
	02-05 T		99-04 D	Chrysler — Town & Country	01-07 D
Lincoln — LS	00-06 D	Volkswagen — Passat	98-05 D	Chrysler — Voyager y Grand Voyager	01-07 D
	00-06 T	Volkswagen — Touareg	04-12 DD	Dodge — Caravan y Grand Caravan	01-07 D
	(Pág. 66)		04-12 DI		(Pág. 126)
<b>904973</b>			04-12 TD	<b>905912</b>	
Monroe® Strut-Mate® Bases de Amortiguador			04-12 TI	Monroe® Strut-Mate® Bases de Amortiguador	
Ford — Expedition	03-06 T	<b>904996</b>	(Pág. 85)	Toyota — Corolla	88-02 DD
		Monroe® Strut-Mate® Bases de Amortiguador			88-02 DI
<b>904974</b>	(Pág. 66)	Honda — Civic	02-05 DD		(Pág. 56, 59)
Monroe® Strut-Mate® Bases de Amortiguador		<b>904997</b>	(Pág. 85)	<b>905914</b>	
Ford — Expedition	03-06 D	Monroe® Strut-Mate® Bases de Amortiguador		Monroe® Strut-Mate® Bases de Amortiguador	
		Honda — Civic	02-05 DI	Dodge — Dakota	06-12 D
<b>904975</b>	(Pág. 87)	<b>905902</b>	(Pág. 58, 93)	Dodge — Pickup Ram 1500	06-08 D
Monroe® Strut-Mate® Bases de Amortiguador		Monroe® Strut-Mate® Bases de Amortiguador			(Pág. 67-70)
Honda — Odyssey (Mini Van)	99-04 DD	Honda — Civic	02-05 DI	<b>905915</b>	
	99-04 DI			Monroe® Strut-Mate® Bases de Amortiguador	
Honda — Pilot	06-08 DD	Dodge — Nitro	07-12 DD	Ford — Five Hundred	05-07 D
	06-08 DI	Jeep — Liberty	02-12 DD		05-07 DD
	03-05 D	<b>905903</b>	(Pág. 58, 93)	Ford — Freestyle	05-07 DI
<b>904985</b>	(Pág. 105-108)	Monroe® Strut-Mate® Bases de Amortiguador		Ford — Mustang	05-07 DD
Monroe® Strut-Mate® Bases de Amortiguador		Dodge — Nitro	07-12 DI		05-07 DI
Nissan — Altima	02-18 TD	Jeep — Liberty	02-12 DI	<b>905917</b>	(Pág. 100)
	02-18 TI	<b>905904</b>	(Pág. 87)	Monroe® Strut-Mate® Bases de Amortiguador	
Nissan — Maxima	16-18 T	Monroe® Strut-Mate® Bases de Amortiguador		Mazda — 6i	03-04 D
	04-14 TD	Honda — Odyssey (Mini Van)	13-17 D		(Pág. 69, 98-100)
	04-14 TI		05-10 DD	<b>905918</b>	
<b>904989</b>	(Pág. 97, 125, 127, 131-132)		05-10 DI	Monroe® Strut-Mate® Bases de Amortiguador	
Monroe® Strut-Mate® Bases de Amortiguador		<b>905906</b>	(Pág. 32, 115)	Ford — Fusion	06-12 D
Lexus — ES330	04-06 DD	Monroe® Strut-Mate® Bases de Amortiguador		Lincoln — MKZ	07-12 D
	04-06 DI	Chevrolet — Aveo	04-18 DD	Mazda — 6i	05-08 D
Lexus — RX330	04-06 DD		04-18 DI		(Pág. 92-93)
	04-06 DI	Pontiac — G3	06-09 DD	<b>905922</b>	
Lexus — RX350	07-09 DD		06-09 DI	Monroe® Strut-Mate® Bases de Amortiguador	
	07-09 DI	<b>905907</b>	(Pág. 36, 115)	Jeep — Commander	06-10 D
Lexus — RX400H	06-07 DD	Monroe® Strut-Mate® Bases de Amortiguador		Jeep — Grand Cherokee	05-10 D
	06-07 DI	Chevrolet — HHR	06-11 D		
Lexus — Camry	02-06 DD				
	02-06 DI				

Números de parte con P (P--) indican accesorios con la unidad



# PROGRESIVO AMORTIGADORES

## INDICE PROGRESIVO DE APLICACIONES

Vehículo	Años Pos.	Vehículo	Años Pos.	Vehículo	Años Pos.
<b>905927</b>	(Pág. 95-96)	<b>905970</b>	(Pág. 49, 55)	<b>906905 (Cont.)</b>	(Pág. 119, 134, 136)
Monroe® Strut-Mate® Bases de Amortiguador Kia — Sorento	03-09 DD 03-09 DI	Monroe® Strut-Mate® Bases de Amortiguador Chrysler — 300, 300C y 300M	05-10 T	Monroe® Strut-Mate® Bases de Amortiguador Volkswagen — Crossfox	05-17 D
<b>905937</b>	(Pág. 97)	Dodge — Challenger	08-19 T	Volkswagen — Derby	99-09 D
Monroe® Strut-Mate® Bases de Amortiguador Lexus — RX350	07-09 TI	Dodge — Charger	06-10 T	Volkswagen — Lupo	03-09 D
<b>905943</b>	(Pág. 105)	<b>905972</b>	(Pág. 52, 54-55)	Volkswagen — Polo	03-08 D
Monroe® Strut-Mate® Bases de Amortiguador Mitsubishi — Lancer	02-05 D	Monroe® Strut-Mate® Asiento y Aislador de Resorte		<b>906906</b>	(Pág. 67)
<b>905944</b>	(Pág. 104-105)	Chrysler — Town & Country	01-07 D	Monroe® Strut-Mate® Suspension Shock Mounting Kit	
Monroe® Strut-Mate® Bases de Amortiguador Mitsubishi — Lancer	02-07 D	Chrysler — Voyager y Grand Voyager	01-07 D	Ford — Fiesta	03-10 T
Mitsubishi — Outlander	03-06 D	Dodge — Caravan y Grand Caravan	01-07 D	<b>906907</b>	(Pág. 34, 38)
<b>905945</b>	(Pág. 104-105)	<b>905980</b>	(Pág. 36, 116)	Monroe® Strut-Mate® Bases de Amortiguador Chevrolet — Chevy, Chevy Joy, Pop y Swing	93-12 D
Monroe® Strut-Mate® Bases de Amortiguador Mitsubishi — Lancer	08-11 TD 08-11 TI 02-07 T	Monroe® Strut-Mate® Bases de Amortiguador Chevrolet — Equinox	05-06 DD 05-06 DI	Chevrolet — Monza	93-12 D
Mitsubishi — Outlander	07-13 TD 07-13 TI 03-06 T	<b>905981</b>	(Pág. 32, 115)	<b>906908</b>	(Pág. 32, 35, 46, 49)
<b>905950</b>	(Pág. 119, 121)	Monroe® Strut-Mate® Bases de Amortiguador Chevrolet — Aveo	04-18 TD 04-18 TI	Monroe® Strut-Mate® Bases de Amortiguador Chevrolet — Astra	00-08 D 00-08 DD 00-08 DI
Monroe® Strut-Mate® Bases de Amortiguador Saab — 9-2x	05-06 TD 05-06 TI	Pontiac — G3	06-09 TD 06-09 TI	Chevrolet — Corsa	01-08 DD 01-08 DI
Subaru — Forester	06-08 TD 06-08 TI	<b>905983</b>	(Pág. 94)	Chevrolet — Tornado	04-10 DD 04-10 DI
Subaru — Impreza	04-07 T	Monroe® Strut-Mate® Bases de Amortiguador Kia — Amanti	07-09 D	Chevrolet — Zafira	00-07 DD 00-07 DI
<b>905951</b>	(Pág. 123)	<b>905984</b>	(Pág. 94)	<b>906912</b>	(Pág. 109, 118)
Monroe® Strut-Mate® Bases de Amortiguador Suzuki — Aerio	02-07 DD 02-07 DI	Monroe® Strut-Mate® Bases de Amortiguador Kia — Amanti	07-09 T	Monroe® Strut-Mate® Bases de Amortiguador Nissan — Platina	02-10 D
<b>905957</b>	(Pág. 126, 128-129)	<b>905985</b>	(Pág. 90-91, 105)	Renault — Clio	01-10 D
Monroe® Strut-Mate® Bases de Amortiguador Toyota — Corolla	03-08 DD 03-08 DI	Monroe® Strut-Mate® Bases de Amortiguador Infiniti — G35	03-07 D 03-07 DD 03-07 DI	Renault — Kangoo	07-09 D
Toyota — MR2 Spyder	00-05 D	Infiniti — M35	06-07 D	Renault — Kangoo Express	04-12 D
Toyota — Prius	04-09 DD 04-09 DI	Infiniti — M45	06-07 D	<b>906914</b>	(Pág. 91, 106, 108, 110)
<b>905959</b>	(Pág. 138, 49)	Nissan — 300ZX	90-96 D	Monroe® Strut-Mate® Bases de Amortiguador Infiniti — I30, I35	02-04 DD 02-04 DI 00-01 D
Monroe® Strut-Mate® Bases de Amortiguador Chrysler — 300, 300C y 300M	05-10 T	Nissan — 350 Z	03-05 D	Nissan — Altima	02-06 DD 02-06 DI
Volvo — S40	00-04 DD 00-04 DI	<b>905989</b>	(Pág. 49-50, 57)	Nissan — Maxima	00-08 DD 00-08 DI
Volvo — V40	00-04 DD 00-04 DI	Monroe® Strut-Mate® Aislador de Resorte Chrysler — 300, 300C y 300M	99-04 D	Nissan — Murano	03-08 DD 03-08 DI
<b>905966</b>	(Pág. 49 55-56)	Chrysler — Concorde	98-04 D	Nissan — Quest (Mini Van)	04-09 DD 04-09 DI
Monroe® Strut-Mate® Bases de Amortiguador Chrysler — 300, 300C y 300M	05-10 D	Chrysler — LHS	98-01 D	<b>906918</b>	(Pág. 66, 97)
Dodge — Challenger	08-19 D	Dodge — Intrepid	98-04 D	Monroe® Strut-Mate® Plato de Montaje Ford — Explorer	02-05 D
Dodge — Charger	06-10 D	<b>906902</b>	(Pág. 63)	Lincoln — Aviator	03-05 D
<b>905969</b>	(Pág. 49, 55-56)	Monroe® Strut-Mate® Bases de Amortiguador Fiat — Palio	03-11 DD	<b>906919</b>	(Pág. 85-86)
Monroe® Strut-Mate® Bases de Amortiguador Chrysler — 300, 300C y 300M	05-10 T	<b>906903</b>	(Pág. 63)	Monroe® Strut-Mate® Bases de Amortiguador Honda — Civic	01-05 DD
Dodge — Challenger	09-10 T	Monroe® Strut-Mate® Bases de Amortiguador Fiat — Palio	03-11 DI	Honda — CR-V	02-06 DD
Dodge — Charger	06-10 T	<b>906904</b>	(Pág. 64, 67)	Honda — Element	03-11 DD
<b>905972</b>	(Pág. 52, 54-55)	Monroe® Strut-Mate® Plato de Montaje Ford — EcoSport	04-12 D	<b>906920</b>	(Pág. 85-86)
Monroe® Strut-Mate® Bases de Amortiguador Chrysler — 300, 300C y 300M	05-10 T	Ford — Fiesta	03-10 D	Monroe® Strut-Mate® Bases de Amortiguador Honda — Civic	01-05 DI
Dodge — Challenger	09-10 T	<b>906905</b>	(Pág. 119, 134, 136)	Honda — CR-V	02-06 DI
Dodge — Charger	06-10 T	Monroe® Strut-Mate® Bases de Amortiguador Seat — Cordoba	03-09 D	Honda — Element	03-11 DI
		Seat — Ibiza	03-09 D		

Números de parte con P (P--) indican accesorios con la unidad



# PROGRESIVO AMORTIGUADORES

## INDICE PROGRESIVO DE APLICACIONES

Vehículo	Años Pos.	Vehículo	Años Pos.	Vehículo	Años Pos.
<b>906927</b>	(Pág. 66)	<b>906960 (Cont.)</b>	(Pág. 51-52, 54, 62, 137)	<b>906980 (Cont.)</b>	(Pág. 99, 137-138)
Monroe® Strut-Mate® Plato de Montaje		Monroe® Strut-Mate® Bases de Amortiguador		Monroe® Strut-Mate® Bases de Amortiguador	
Ford — Explorer	02-05 T	Volkswagen — Routan	09-12 D	Mazda — 5	12-15 DD
<b>906936</b>	(Pág. 52, 117, 122, 126, 128)	<b>906962</b>	(Pág. 68, 76-77, 98)		12-15 DI
Monroe® Strut-Mate® Aislador de Resorte		Monroe® Strut-Mate® Bases de Amortiguador			06-10 DD
Chrysler — Verna	00-06 T	Ford — Flex	08-09 D		06-10 DI
Pontiac — Vibe	03-08 D	Ford — Taurus X	08-09 D	Volvo — C70	08-13 DD
Subaru — Impreza	02-03 T	Lincoln — MKS	09-11 D		08-13 DI
Toyota — Corolla	03-08 D	<b>906963</b>	(Pág. 65-66, 71-72, 98)	Volvo — S40	05-11 DD
Toyota — Matrix	03-08 D	Monroe® Strut-Mate® Bases de Amortiguador			05-11 DI
<b>906941</b>	(Pág. 138)	Ford — Expedition	07-17 D	Volvo — V50	05-11 DD
Monroe® Strut-Mate® Aislador de Resorte		Ford — Pickup Serie F-100, F-150,	09-13 D		05-11 DI
Volvo — S60	01-09 D	Lobo		<b>906981</b>	(Pág. 64-65, 68-69, 97, 99)
Volvo — S80	99-06 D	Lincoln — Navigator	07-19 D	Monroe® Strut-Mate® Bases de Amortiguador	
Volvo — V70	00-07 D	<b>906964</b>	(Pág. 85)	Ford — C-Max	13-18 T
<b>906956</b>	(Pág. 33-34, 36, 114)	Monroe® Strut-Mate® Bases de Amortiguador		Ford — Escape	2019 TD
Monroe® Strut-Mate® Bases de Amortiguador		Honda — Civic	06-11 D		2019 TI
Chevrolet — Captiva	08-11 DD		06-11 DD	Ford — Focus	2013 TI
	08-11 DI		06-11 DI		17-18 T
Chevrolet — Captiva Sport	12-15 DD	<b>906965</b>	(Pág. 86-87)		12-18 TD
	12-15 DI	Monroe® Strut-Mate® Bases de Amortiguador		Lincoln — MKC	12-18 TI
Chevrolet — Equinox	07-17 DD	Honda — Fit	09-14 D		15-19 TD
	07-17 DI		06-08 DD	Mazda — 3	15-19 TI
Pontiac — Torrent	07-09 DD		06-08 DI		04-13 T
	07-09 DI	Honda — Insight	10-14 D		04-13 TD
<b>906958</b>	(Pág. 49, 51, 53)	<b>906966</b>	(Pág. 86)	Mazda — 5	12-15 TD
Monroe® Strut-Mate® Bases de Amortiguador		Monroe® Strut-Mate® Bases de Amortiguador			12-15 TI
Chrysler — 200	11-14 DD	Honda — CR-V	07-14 DD		06-10 TD
	11-14 DI		07-14 DI		06-10 TI
Chrysler — Cirrus	07-10 DD	<b>906967</b>	(Pág. 88)	<b>906982</b>	(Pág. 101)
	07-10 DI	Monroe® Strut-Mate® Bases de Amortiguador		Monroe® Strut-Mate® Bases de Amortiguador	
Chrysler — Sebring	07-10 DD	Hyundai — Elantra	07-11 DD	Mazda — MX-5 Miata	06-08 D
	07-10 DI		07-11 DI		06-08 T
Dodge — Avenger	07-14 DD	<b>906968</b>	(Pág. 88-89, 95)	Mazda — RX-8	04-08 D
	07-14 DI	Monroe® Strut-Mate® Bases de Amortiguador			04-08 T
<b>906959</b>	(Pág. 49, 51, 53, 54, 92-93)	Hyundai — Entourage	07-08 DD	<b>906983</b>	(Pág. 103)
Monroe® Strut-Mate® Bases de Amortiguador			07-08 DI	Monroe® Strut-Mate® Bases de Amortiguador	
Chrysler — 200	11-14 TD	Hyundai — Santa Fe	07-09 D	Mini — Cooper	02-08 DD
	11-14 TI	Kia — Sedona	06-12 DD		02-08 DI
Chrysler — Cirrus	07-10 TD		06-12 DI	<b>906985</b>	(Pág. 119)
	07-10 TI	<b>906969</b>	(Pág. 53, 95)	Monroe® Strut-Mate® Bases de Amortiguador	
Chrysler — Sebring	07-10 TD	Monroe® Strut-Mate® Bases de Amortiguador		Saab — 9-3	09-11 D
	07-10 TI	Dodge — Attitude	06-11 DD		03-08 DD
Dodge — Avenger	07-14 TD	<b>906970</b>	(Pág. 53, 95)		03-08 DI
	07-14 TI	Monroe® Strut-Mate® Bases de Amortiguador		<b>906986</b>	(Pág. 124-125, 127, 133)
Dodge — Caliber	07-12 TD	Dodge — Attitude	06-11 DI	Monroe® Strut-Mate® Bases de Amortiguador	
	07-12 TI	<b>906971</b>	(Pág. 53, 95)	Toyota — Avalon	06-12 DD
Jeep — Compass	07-17 TD	Monroe® Strut-Mate® Bases de Amortiguador			06-12 DI
	07-17 TI	Dodge — Attitude	06-11 TD	Toyota — Camry	07-17 DD
Jeep — Patriot	07-17 TD		06-11 TI		07-17 DI
	07-17 TI	<b>906980</b>	(Pág. 99, 137-138)	Toyota — Highlander	08-13 DD
<b>906960</b>	(Pág. 51-52, 54, 62, 137)	Monroe® Strut-Mate® Bases de Amortiguador			08-13 DI
Monroe® Strut-Mate® Bases de Amortiguador		Mazda — 3	04-13 D	Toyota — Venza	09-12 DD
Chrysler — Town & Country	08-16 D		04-13 DD		09-12 DI
Chrysler — Voyager y Grand Voyager	12-16 D		04-13 DI	<b>906987</b>	(Pág. 129-130)
Dodge — Caravan y Grand Caravan	08-16 D			Monroe® Strut-Mate® Bases de Amortiguador	
Dodge — Ram Cargo Caravan (C/V)	12-15 D			Toyota — Prius	10-15 DD
					10-15 DI

Números de parte con P (P--) indican accesorios con la unidad



# PROGRESIVO AMORTIGUADORES

## INDICE PROGRESIVO DE APLICACIONES

Vehículo	Años Pos.	Vehículo	Años Pos.	Vehículo	Años Pos.
<b>906987 (Cont.)</b> (Pág. 129-130)		<b>907930 (Cont.)</b> (Pág. 59, 117)		<b>907949 (Cont.)</b> (Pág. 24, 133-137)	
Monroe® Strut-Mate® Bases de Amortiguador		Monroe® Strut-Mate® Bases de Amortiguador		Monroe® Strut-Mate® Bases de Amortiguador	
Toyota — RAV4	09-12 DD	RAM — Serie 1500	11-18 D	Volkswagen — Eos	07-16 D
	09-12 DI	<b>907931</b> (Pág. 59, 117)		Volkswagen — Golf SportWagen	10-13 D
	06-08 D	Monroe® Strut-Mate® Asiento de Resorte		Volkswagen — GTI	06-14 D
<b>906988</b> (Pág. 120, 130)		Dodge — Pickup Ram 1500	09-18 D	Volkswagen — Jetta	11-18 D
Monroe® Strut-Mate® Bases de Amortiguador		RAM — Serie 1500	11-18 D	Volkswagen — Passat	2012 D
Scion — xB	08-15 DD	<b>907932</b> (Pág. 91, 106, 111)		Volkswagen — Passat CC	06-10 D
	08-15 DI	Monroe® Strut-Mate® Bases de Amortiguador		Volkswagen — Tiguan	09-12 D
Toyota — RAV4	06-08 D	Nissan — Armada	05-15 D	<b>907952</b> (Pág. 89-90)	
<b>906989</b> (Pág. 120, 129, 133)		Nissan — Titan Pickup	04-15 D	Monroe® Strut-Mate® Aislador de Resorte	
Monroe® Strut-Mate® Bases de Amortiguador		<b>907933</b> (Pág. 106, 111)		Hyundai — Santa Fe	07-09 D
Scion — xD	08-14 DD	Monroe® Strut-Mate® Aislador de Resorte		Hyundai — Veracruz	07-12 D
	08-14 DI	Nissan — Armada	05-15 D	<b>907956</b> (Pág. 85)	
Toyota — Prius C	16-19 D	Nissan — Titan Pickup	04-15 D	Monroe® Strut-Mate® Aislador de Resorte	
	12-15 DD	<b>907934</b> (Pág. 65-66, 98)		Honda — Civic	06-15 DI
	12-15 DI	Monroe® Strut-Mate® Bases de Amortiguador		<b>907964</b> (Pág. 104-105)	
Toyota — Prius V	12-16 DD	Ford — Expedition	07-17 T	Monroe® Strut-Mate® Aislador de Resorte	
	12-16 DI	Lincoln — Navigator	07-19 T	Mitsubishi — Lancer	02-07 D
Toyota — Yaris	06-14 DD	<b>907937</b> (Pág. 66-67)		Mitsubishi — Outlander	03-06 D
	06-14 DI	Monroe® Strut-Mate® Bases de Amortiguador		<b>907967</b> (Pág. 25-26)	
<b>906995</b> (Pág. 49, 55-56)		Ford — Explorer	06-10 D	Monroe® Strut-Mate® Aislador de Resorte	
Monroe® Strut-Mate® Aislador de Resorte		<b>907940</b> (Pág. 66-67)		BMW — 325i	06-13 D
Chrysler — 300, 300C y 300M	05-10 D	Monroe® Strut-Mate® Bases de Amortiguador		BMW — 328i (E90)	07-13 D
Dodge — Challenger	08-19 D	Ford — Explorer	06-10 T	BMW — 335i (E90, 92, 93)	07-15 D
Dodge — Charger	06-10 D	<b>907942</b> (Pág. 31-32, 40-41, 43-46, 79-80, 83)		<b>907971</b> (Pág. 56, 59)	
<b>907914</b> (Pág. 85, 86)		Monroe® Strut-Mate® Aislador de Resorte		Monroe® Strut-Mate® Buje de Brazo de Control	
Monroe® Strut-Mate® Aislador de Resorte		Cadillac — Escalade	07-16 D	Dodge — Dakota	05-08 D
Honda — Civic	01-05 T	Chevrolet — Avalanche	07-13 D	Dodge — Pickup Ram 1500	06-08 D
Honda — CR-V	02-11 T	Chevrolet — Pickup Silverado	07-18 D	<b>907973</b> (Pág. 25)	
<b>907921</b> (Pág. 132)		Chevrolet — Suburban	07-18 D	Monroe® Strut-Mate® Asiento de Resorte	
Monroe® Strut-Mate® Plato de Montaje		Chevrolet — Tahoe	07-18 D	BMW — 325i	01-05 D
Toyota — Tacoma	05-15 D	GMC — Pickup Sierra 1500	07-18 D	<b>907983</b> (Pág. 23, 87)	
<b>907922</b> (Pág. 123, 126)		GMC — Yukon	07-14 D	Monroe® Strut-Mate® Bases de Amortiguador	
Monroe® Strut-Mate® Plato de Montaje		<b>907943</b> (Pág. 120)		Acura — MDX	07-13 DD
Toyota — FJ Cruiser	07-13 D	Monroe® Strut-Mate® Bases de Amortiguador		Scion — iC	07-13 DI
<b>907925</b> (Pág. 29, 132-133)		Scion — iC	05-10 DD	Honda — Ridgeline	06-14 DD
Monroe® Strut-Mate® Plato de Montaje			05-10 DI		06-14 DI
Toyota — Tundra	00-06 D	<b>907944</b> (Pág. 64, 70)		<b>907984</b> (Pág. 25-26)	
<b>907926</b> (Pág. 132-133)		Monroe® Strut-Mate® Plato de Montaje		Monroe® Strut-Mate® Bases de Amortiguador	
Monroe® Strut-Mate® Aislador de Resorte		Ford — Crown Victoria	03-11 D	BMW — 328i (E90)	07-13 T
Toyota — Tundra	00-06 D	Ford — Grand Marquis	03-11 D	BMW — 335i (E90, 92, 93)	07-15 T
<b>907927</b> (Pág. 132)		<b>907947</b> (Pág. 24, 133-135)		<b>907986</b> (Pág. 29, 47, 78)	
Monroe® Strut-Mate® Plato de Montaje		Monroe® Strut-Mate® Bases de Amortiguador		Monroe® Strut-Mate® Bases de Amortiguador	
Toyota — Tacoma	95-04 D	Audi — A3	05-13 T	Buick — Enclave	08-17 D
<b>907928</b> (Pág. 107, 109, 112)		Volkswagen — Beetle	12-18 T	Chevrolet — Traverse	09-17 D
Monroe® Strut-Mate® Plato de Montaje		Volkswagen — Bora	05-11 T	GMC — Acadia	07-16 D
Nissan — Frontier Pickup	05-19 D	Volkswagen — Eos	07-16 T	<b>907987</b> (Pág. 29-30, 36, 38)	
Nissan — Pathfinder	05-12 D	Volkswagen — Golf SportWagen	10-13 T	Monroe® Strut-Mate® Bases de Amortiguador	
Nissan — Xterra	05-15 D	Volkswagen — GTI	06-14 T	Buick — LaCrosse	10-15 DD
<b>907929</b> (Pág. 107, 109, 112)		Volkswagen — Jetta	11-18 T		10-15 DI
Monroe® Strut-Mate® Aislador de Resorte		<b>907949</b> (Pág. 24, 133-137)		Buick — Regal	15-17 D
Nissan — Frontier Pickup	05-19 D	Monroe® Strut-Mate® Bases de Amortiguador			15-17 DD
Nissan — Pathfinder	05-12 D	Audi — A3	05-13 D		15-17 DI
Nissan — Xterra	05-15 D	Audi — TT	08-15 D	Chevrolet — Malibu	13-15 DD
<b>907930</b> (Pág. 59, 117)		Volkswagen — Beetle	12-18 D		13-15 DI
Monroe® Strut-Mate® Bases de Amortiguador		Volkswagen — Bora	05-11 D		
Dodge — Pickup Ram 1500	09-18 D	Volkswagen — CC	09-17 D		

Números de parte con P (P--) indican accesorios con la unidad



# PROGRESIVO AMORTIGUADORES

## INDICE PROGRESIVO DE APLICACIONES

Vehículo	Años Pos.	Vehículo	Años Pos.	Vehículo	Años Pos.
<b>907990</b>	(Pág. 38)	<b>908912</b>	(Pág. 104-105)	<b>908942</b>	(Pág. 116, 125-126, 128)
Monroe® Strut-Mate® Bases de Amortiguador		Monroe® Strut-Mate® Bases de Amortiguador		Monroe® Strut-Mate® Bases de Amortiguador	
Chevrolet — Malibu	08-12 TD	Mitsubishi — Lancer	08-11 DD	Pontiac — Vibe	09-10 DD
	08-12 TI		08-11 DI		09-10 DD
<b>907991</b>	(Pág. 30, 33)	Mitsubishi — Outlander	07-13 DD		09-10 DI
Monroe® Strut-Mate® Bases de Amortiguador			07-13 DI	Toyota — Corolla	09-18 DD
Buick — Regal	11-14 DD	<b>908913</b>	(Pág. 106, 108)		09-18 DI
	11-14 DI	Monroe® Strut-Mate® Bases de Amortiguador		Toyota — Matrix	09-13 D
Chevrolet — Camaro	13-15 DD	Nissan — Altima	07-12 DD		09-13 DD
	13-15 DI		07-12 DI		09-13 DI
<b>907992</b>	(Pág. 33)	Nissan — Maxima	09-14 DD	<b>908944</b>	(Pág. 103-104)
Monroe® Strut-Mate® Bases de Amortiguador			09-14 DI	Monroe® Strut-Mate® Bases de Amortiguador	
Chevrolet — Camaro	13-15 TD	<b>908914</b>	(Pág. 110)	Mitsubishi — Eclipse	06-12 D
	13-15 TI	Monroe® Strut-Mate® Bases de Amortiguador		Mitsubishi — Galant	04-11 DD
<b>907994</b>	(Pág. 54, 92-93)	Nissan — Rogue	08-12 DI		04-11 DI
Monroe® Strut-Mate® Bases de Amortiguador		Nissan — Sentra	07-12 DI	<b>908946</b>	(Pág. 39)
Dodge — Caliber	07-12 DD	<b>908915</b>	(Pág. 110)	Monroe® Strut-Mate® Bases de Amortiguador	
	07-12 DI	Monroe® Strut-Mate® Bases de Amortiguador		Chevrolet — Optra	06-10 DD
Jeep — Compass	07-17 DD	Nissan — Rogue	08-12 DD		06-10 DI
	07-17 DI	Nissan — Sentra	07-12 DD	<b>908947</b>	(Pág. 39)
Jeep — Patriot	07-17 DD	<b>908916</b>	(Pág. 106, 110-111)	Monroe® Strut-Mate® Bases de Amortiguador	
	07-17 DI	Monroe® Strut-Mate® Bases de Amortiguador		Chevrolet — Optra	06-10 TD
<b>907995</b>	(Pág. 58)	Nissan — Cube	09-14 DI		06-10 TI
Monroe® Strut-Mate® Bases de Amortiguador		Nissan — Rogue	12-14 DD	<b>908958</b>	(Pág. 51)
Dodge — Journey	09-10 TD	Nissan — Tiida	07-18 DI	Monroe® Strut-Mate® Aislador de Resorte	
	09-10 TI	<b>908917</b>	(Pág. 106, 110-111)	Chrysler — Pacifica	04-08 D
<b>907996</b>	(Pág. 67, 99)	Monroe® Strut-Mate® Bases de Amortiguador		<b>908959</b>	(Pág. 51)
Monroe® Strut-Mate® Bases de Amortiguador		Nissan — Cube	09-14 DD	Monroe® Strut-Mate® Asiento de Resorte	
Ford — Fiesta	11-13 DD	Nissan — Rogue	12-14 DI	Chrysler — Pacifica	04-08 D
	11-13 DI	Nissan — Tiida	07-18 DD	<b>908961</b>	(Pág. 64-65, 68-69, 77, 97)
Mazda — 2	11-14 DD	<b>908920</b>	(Pág. 127)	Monroe® Strut-Mate® Bases de Amortiguador	
	11-14 DI	Monroe® Strut-Mate® Bases de Amortiguador		Ford — C-Max	13-18 D
<b>907997</b>	(Pág. 67, 99)	Toyota — Highlander	08-13 TD	Ford — Escape	2019 DD
Monroe® Strut-Mate® Bases de Amortiguador		<b>908921</b>	(Pág. 127)		2019 DI
Ford — Fiesta	11-19 TD	Monroe® Strut-Mate® Bases de Amortiguador			2013 DD
	11-19 TI	Toyota — Highlander	08-13 TI		2013 DI
Mazda — 2	11-14 TD	<b>908924</b>	(Pág. 30, 36)	Ford — Focus	17-18 D
	11-14 TI	Monroe® Strut-Mate® Bases de Amortiguador			12-16 DD
<b>907999</b>	(Pág. 68, 76-77, 98)	Buick — Regal	11-17 TI	Ford — Transit	12-16 DI
Monroe® Strut-Mate® Aislador de Resorte		<b>908925</b>	(Pág. 30, 36)		14-18 DD
Ford — Flex	08-19 D	Monroe® Strut-Mate® Bases de Amortiguador			14-18 DI
Ford — Taurus X	08-09 D	Buick — Regal	11-17 TD	Lincoln — MKC	15-19 DD
Lincoln — MKS	09-12 D	<b>908926</b>	(Pág. 120-123)		15-19 DI
Lincoln — MKT	10-19 D	Monroe® Strut-Mate® Bases de Amortiguador		<b>908962</b>	(Pág. 56, 59, 117)
<b>908900</b>	(Pág. 77)	Subaru — Crosstrek	16-17 DD	Monroe® Strut-Mate® Buje de Brazo de Control	
Monroe® Strut-Mate® Bases de Amortiguador			16-17 DI	Dodge — Dakota	09-12 D
Ford — Transit	10-13 D	Subaru — Forester	09-17 DD	Dodge — Pickup Ram 1500	09-18 D
	99-01 D		09-17 DI	RAM — Serie 1500	11-18 D
<b>908907</b>	(Pág. 100-101)	Subaru — Impreza	12-14 D	<b>908963</b>	(Pág. 64, 67, 70)
Monroe® Strut-Mate® Bases de Amortiguador			08-14 DD	Monroe® Strut-Mate® Bases de Amortiguador	
Mazda — CX-7	07-12 DD		08-14 DI	Ford — Courier Pickup	00-12 D
	07-12 DI	Subaru — Legacy	05-09 DD	Ford — Fiesta	98-05 D
Mazda — CX-9	07-15 DD		05-09 DI	Ford — Ikon	98-08 D
	07-15 DI	Subaru — Outback	05-09 DD	Ford — KA	01-08 D
<b>908910</b>	(Pág. 103)		05-09 DI	<b>908964</b>	(Pág. 67, 70)
Monroe® Strut-Mate® Bases de Amortiguador		Subaru — XV Crosstrek	13-15 DD	Monroe® Strut-Mate® Bases de Amortiguador	
Mini — Cooper	07-16 DD		13-15 DI	Ford — Fiesta	98-05 T
	07-16 DI			Ford — Ikon	98-08 T
				Ford — KA	01-08 T

Números de parte con P (P--) indican accesorios con la unidad





# PROGRESIVO AMORTIGUADORES

## INDICE PROGRESIVO DE APLICACIONES

Vehículo	Años Pos.	Vehículo	Años Pos.	Vehículo	Años Pos.
<b>908965</b>	(Pág. 124-125)	<b>908997 (Cont.)</b>	(Pág. 88-89, 94)	<b>909916</b>	(Pág. 66, 68, 98)
Monroe® Strut-Mate® Bases de Amortiguador		Monroe® Strut-Mate® Plato de Montaje		Monroe® Strut-Mate® Bases de Amortiguador	
Toyota — Avalon	06-12 TI	Kia — Optima	12-15 DD	Ford — Explorer	12-19 D
	05-06 TD		12-15 DI		12-19 DD
Toyota — Camry	07-11 TD		11-15 D		12-19 DI
<b>908966</b>	(Pág. 124-125)	<b>908998</b>	(Pág. 108)	Ford — Flex	13-19 D
Monroe® Strut-Mate® Bases de Amortiguador		Monroe® Strut-Mate® Plato de Montaje		Lincoln — MKT	13-19 DD
Toyota — Avalon	06-12 TD	Nissan — Murano	09-13 D		13-19 DI
	05-06 TI	<b>908999</b>	(Pág. 93)	<b>909917</b>	(Pág. 23, 84, 86)
Toyota — Camry	07-11 TI	Monroe® Strut-Mate® Plato de Montaje		Monroe® Strut-Mate® Plato de Montaje	
<b>908970</b>	(Pág. 54)	Jeep — Grand Cherokee	11-15 T	Acura — TSX	09-14 DI
Monroe® Strut-Mate® Aislador de Resorte		<b>909905</b>	(Pág. 66)	Honda — Accord	08-12 DI
Dodge — Caliber	07-12 D	Monroe® Strut-Mate® Bases de Amortiguador		Honda — Crosstour	12-15 DI
<b>908981</b>	(Pág. 89)	Ford — Explorer	11-12 DD	<b>909918</b>	(Pág. 23, 84, 86)
Monroe® Strut-Mate® Aislador de Resorte			11-12 DI	Monroe® Strut-Mate® Plato de Montaje	
Hyundai — Santa Fe	01-06 D	<b>909906</b>	(Pág. 64, 70, 98)	Acura — TSX	09-14 DD
<b>908983</b>	(Pág. 49, 58)	Monroe® Strut-Mate® Bases de Amortiguador		Honda — Accord	08-12 DD
Monroe® Strut-Mate® Aislador de Resorte		Ford — Edge	11-14 DD	Honda — Crosstour	12-15 DD
Chrysler — 200	11-14 D		11-14 DI	<b>909920</b>	(Pág. 86)
Dodge — Journey	11-19 D	Ford — Mustang	11-14 D	Monroe® Strut-Mate® Bases de Amortiguador	
<b>908984</b>	(Pág. 58)	Lincoln — MKX	11-15 DD	Honda — Element	07-11 T
Monroe® Strut-Mate® Bases de Amortiguador			11-15 DI		03-06 D
Dodge — Journey	09-19 DD	<b>909908</b>	(Pág. 26, 27, 28)	<b>909921</b>	(Pág. 35)
	09-19 DI	Monroe® Strut-Mate® Bases de Amortiguador		Monroe® Strut-Mate® Asiento de Resorte	
	09-10 D	BMW — 525i	04-07 TD	Chevrolet — Colorado Pickup	04-12 D
<b>908988</b>	(Pág. 126)		04-07 TI	<b>909922</b>	(Pág. 23, 84, 86)
Monroe® Strut-Mate® Plato de Montaje		BMW — 528i	08-10 TD	Monroe® Strut-Mate® Aislador de Resorte	
Toyota — Corolla	03-08 TD		08-10 TI	Acura — TL	09-14 D
<b>908993</b>	(Pág. 30, 35-36)	BMW — 530i	04-07 TD	Acura — TSX	09-14 D
Monroe® Strut-Mate® Plato de Montaje			04-07 TI	Honda — Accord	08-12 D
Buick — Verano	12-17 TD	BMW — 535i	11-17 T	Honda — Crosstour	12-15 D
	12-17 TI		08-10 TD	<b>909923</b>	(Pág. 29, 47, 78)
Chevrolet — Cruze	10-15 TD	BMW — 545i	08-10 TI	Monroe® Strut-Mate® Aislador de Resorte	
	10-15 TI		04-05 TD	Buick — Enclave	08-17 D
<b>908994</b>	(Pág. 100)	BMW — 545i	04-05 TI	Chevrolet — Traverse	09-17 D
Monroe® Strut-Mate® Plato de Montaje		BMW — 550i	06-10 TD	GMC — Acadia	07-16 D
Mazda — 6	09-13 DD		06-10 TI	<b>909924</b>	(Pág. 29, 47, 78)
	09-13 DI	BMW — 645Ci	04-05 T	Monroe® Strut-Mate® Aislador de Resorte	
<b>908995</b>	(Pág. 30, 35-36)	<b>909909</b>	(Pág. 30, 31)	Buick — Enclave	08-17 D
Monroe® Strut-Mate® Plato de Montaje		Monroe® Strut-Mate® Bases de Amortiguador		Chevrolet — Traverse	09-17 D
Buick — Verano	12-17 DD	Cadillac — ATS	13-15 D	GMC — Acadia	07-16 D
	12-17 DI		13-15 DD	<b>909925</b>	(Pág. 110)
Chevrolet — Cruze	10-15 DD	Cadillac — CTS	13-15 DI	Monroe® Strut-Mate® Aislador de Resorte	
	10-15 DI		14-19 D	Nissan — Sentra	07-12 D
<b>908996</b>	(Pág. 87)		14-19 DD	<b>909927</b>	(Pág. 86)
Monroe® Strut-Mate® Plato de Montaje		<b>909913</b>	(Pág. 132)	Monroe® Strut-Mate® Asiento de Resorte	
Honda — Odyssey (Mini Van)	11-12 DD	Monroe® Strut-Mate® Bases de Amortiguador		Honda — Element	03-11 D
	11-12 DI	Toyota — Tacoma	05-15 DD	<b>909929</b>	(Pág. 69)
Honda — Pilot	09-15 DD		05-15 DI	Monroe® Strut-Mate® Aislador de Resorte	
	09-15 DI	<b>909914</b>	(Pág. 68, 76-77, 98)	Ford — Fusion	10-12 D
<b>908997</b>	(Pág. 88-89, 94)	Monroe® Strut-Mate® Bases de Amortiguador		<b>909930</b>	(Pág. 86)
Monroe® Strut-Mate® Plato de Montaje		Ford — Flex	08-09 D	Monroe® Strut-Mate® Aislador de Resorte	
Hyundai — Azera	12-17 D	Ford — Taurus X	08-09 D	Honda — Element	03-11 D
Hyundai — Sonata	12-14 DD	Lincoln — MKS	09-11 D	<b>909931</b>	(Pág. 129-130, 120)
	12-14 DI			Monroe® Strut-Mate® Aislador de Resorte	
	11-15 D			Scion — tC	11-16 D
Kia — Cadenza	14-16 D			Toyota — Prius	10-15 D
				Toyota — Prius V	12-16 D

Números de parte con P (P--) indican accesorios con la unidad



# PROGRESIVO AMORTIGUADORES

## INDICE PROGRESIVO DE APLICACIONES

Vehículo	Años Pos.	Vehículo	Años Pos.	Vehículo	Años Pos.
<b>909931 (Cont.)</b> Monroe® Strut-Mate® Aislador de Resorte Toyota — RAV4	(Pág. 129-130, 120) 06-18 D	<b>909978</b> Monroe® Strut-Mate® Aislador de Resorte Honda — Odyssey (Mini Van)	(Pág. 87) 05-07 D	<b>911055 (Cont.)</b> Monroe® Reflex® Camionetas Ligeras Amortiguador Ford — Pickup Serie F-350	(Pág. 73-74) 85-98 D
<b>909939</b> Monroe® Strut-Mate® Asiento de Resorte Toyota — RAV4	(Pág. 130) 00-05 D	<b>909981</b> Monroe® Strut-Mate® Bases de Amortiguador Lincoln — MKZ Volvo — S80 Volvo — XC60	(Pág. 69, 98, 138) 13-19 D 10-16 D 10-17 DD 10-17 DI	<b>911085</b> Monroe® Reflex® Camionetas Ligeras Amortiguador Chevrolet — Suburban Chevrolet — Van 1500 Express, Savana, Modelos G y P Chevrolet — Van Cargo Van	(Pág. 44, 47-48) 92-99 T 96-14 T 97-00 T
<b>909940</b> Monroe® Strut-Mate® Aislador de Resorte Toyota — RAV4	(Pág. 130) 00-05 D	<b>909986</b> Monroe® Strut-Mate® Bases de Amortiguador Dodge — Dart	(Pág. 56-57) 13-16 DD	<b>911096</b> Monroe® Reflex® Camionetas Ligeras Amortiguador Dodge — Van Ram	(Pág. 63) 70-03 D
<b>909942</b> Monroe® Strut-Mate® Asiento de Resorte Toyota — Highlander	(Pág. 127) 08-13 D	<b>909987</b> Monroe® Strut-Mate® Bases de Amortiguador Dodge — Dart	(Pág. 56-57) 13-16 DI	<b>911128</b> Monroe® Reflex® Camionetas Ligeras Amortiguador Ford — Van Econoline Ford — Van Serie E	(Pág. 78) 10-14 D 92-07 D
<b>909943</b> Monroe® Strut-Mate® Aislador de Resorte Toyota — Highlander	(Pág. 127) 04-07 D	<b>909988</b> Monroe® Strut-Mate® Aislador de Resorte Dodge — Dart	(Pág. 56-57) 13-16 D	<b>911131</b> Monroe® Reflex® Camionetas Ligeras Amortiguador Ford — Pickup Serie F-100, F-150, Lobo Ford — Pickup Serie F-250	(Pág. 71-72) 97-04 D 97-99 D
<b>909945</b> Monroe® Strut-Mate® Aislador de Resorte Honda — Civic	(Pág. 85) 06-11 D	<b>909989</b> Monroe® Strut-Mate® Aislador de Resorte Dodge — Dart	(Pág. 56-57) 13-16 D	<b>911132</b> Monroe® Reflex® Camionetas Ligeras Amortiguador Ford — Pickup Serie F-100, F-150, Lobo	(Pág. 71) 97-03 T
<b>909947</b> Monroe® Strut-Mate® Plato de Montaje Chrysler — Sebring Dodge — Sebring Dodge — Stratus Mitsubishi — Eclipse Mitsubishi — Galant	(Pág. 51, 62, 104) 01-05 T 01-05 T 01-05 T 00-05 T 99-03 T	<b>911039</b> Monroe® Reflex® Camionetas Ligeras Amortiguador Ford — Pickup Serie F-100, F-150, Lobo Ford — Pickup Serie F-250 Ford — Pickup Serie F-350	(Pág. 95) 13-16 D 92-96 T 08-16 T 85-04 T	<b>911134</b> Monroe® Reflex® Camionetas Ligeras Amortiguador Ford — Pickup Serie F-100, F-150, Lobo	(Pág. 72) 97-03 T
<b>909949</b> Monroe® Strut-Mate® Aislador de Resorte Hyundai — Elantra	(Pág. 88) 07-11 D	<b>911043</b> Monroe® Reflex® Camionetas Ligeras Amortiguador Chevrolet — Pickup K y V Chevrolet — Suburban GMC — Pickup Series C, R, K y V GMC — Yukon	(Pág. 39, 45, 82-83) 90-96 T 92-96 T 08-16 T 85-04 T	<b>911140</b> Monroe® Reflex® Camionetas Ligeras Amortiguador Dodge — Dakota Dodge — Durango	(Pág. 56-57) 97-04 T 98-03 T
<b>909955</b> Monroe® Strut-Mate® Asiento de Resorte Toyota — Corolla Toyota — Matrix	(Pág. 125-126, 128) 09-18 D 09-13 D	<b>911044</b> Monroe® Reflex® Camionetas Ligeras Amortiguador Chevrolet — Pickup K y V Chevrolet — Pickup C y R GMC — Pickup Series C, R, K y V	(Pág. 39-40, 39, 81-82) 87-00 D 92-99 D 87-00 D 95-99 D	<b>911149</b> Monroe® Reflex® Camionetas Ligeras Amortiguador Chevrolet — Pickup Silverado GMC — Pickup Sierra 1500	(Pág. 41, 80) 99-07 D 99-07 D
<b>909956</b> Monroe® Strut-Mate® Aislador de Resorte Toyota — Corolla Toyota — Prius	(Pág. 126, 129) 03-13 D 04-09 D	<b>911050</b> Monroe® Reflex® Camionetas Ligeras Amortiguador Chevrolet — Pickup C y R Chevrolet — Suburban Chevrolet — Van 1500 Express, Savana, Modelos G y P Chevrolet — Van Cargo Van GMC — Pickup Series C, R, K y V	(Pág. 39, 44, 47-48, 81-82) 87-00 D 87-00 T 87-02 T 87-00 D 92-99 D 96-02 D 97-00 D 87-02 D	<b>911150</b> Monroe® Reflex® Camionetas Ligeras Amortiguador Chevrolet — Pickup Cheyenne Chevrolet — Pickup Silverado GMC — Pickup Sierra 1500	(Pág. 39, 41, 80) 07-18 T 99-07 T 99-07 T
<b>909957</b> Monroe® Strut-Mate® Aislador de Resorte Toyota — Corolla	(Pág. 125-126) 09-18 D	<b>911055</b> Monroe® Reflex® Camionetas Ligeras Amortiguador Ford — Pickup Serie F-250	(Pág. 73-74) 87-96 D	<b>911151</b> Monroe® Reflex® Camionetas Ligeras Amortiguador Chevrolet — Pickup Silverado GMC — Pickup Sierra 1500	(Pág. 41, 80) 99-07 D 99-07 D
<b>909959</b> Monroe® Strut-Mate® Asiento de Resorte Honda — CR-V	(Pág. 86) 07-11 T				
<b>909962</b> Monroe® Strut-Mate® Asiento de Resorte Scion — iC Toyota — Corolla Toyota — Prius	(Pág. 120, 126, 129) 05-10 D 03-08 D 04-09 D				
<b>909969</b> Monroe® Strut-Mate® Aislador de Resorte Chrysler — Sebring Dodge — Sebring Dodge — Stratus Mitsubishi — Eclipse Mitsubishi — Galant	(Pág. 51, 62, 104) 01-05 T 01-05 T 01-05 T 00-05 T 99-03 T				
<b>909977</b> Monroe® Strut-Mate® Asiento de Resorte Honda — Odyssey (Mini Van)	(Pág. 87) 05-07 D				

Números de parte con P (P--) indican accesorios con la unidad



# PROGRESIVO AMORTIGUADORES

## INDICE PROGRESIVO DE APLICACIONES

Vehículo	Años Pos.	Vehículo	Años Pos.	Vehículo	Años Pos.
<b>911152</b>	(Pág. 41, 80)	<b>911181 (Cont.)</b>	(Pág. 32, 41-42, 44-45, 79-81)	<b>911221</b>	(Pág. 59-60, 117)
Monroe® Reflex® Camionetas Ligeras Amortiguador		Monroe® Reflex® Camionetas Ligeras Amortiguador		Monroe® Reflex® Camionetas Ligeras Amortiguador	
Chevrolet — Pickup Silverado	99-07 T	GMC — Pickup Sierra 3500	01-10 D	Dodge — Pickup Ram 1500	06-08 D
GMC — Pickup Sierra 1500	99-07 T			Dodge — Pickup Ram 2500	03-10 D
<b>911164</b>	(Pág. 41-42, 79-81)	<b>911186</b>	(Pág. 59)	Dodge — Pickup Ram 3500	03-10 D
Monroe® Reflex® Camionetas Ligeras Amortiguador		Monroe® Reflex® Camionetas Ligeras Amortiguador		RAM — Serie 2500	10-13 D
Chevrolet — Pickup Silverado	99-10 T	Dodge — Pickup Ram 1500	02-08 D	<b>911222</b>	(Pág. 59-60, 117)
GMC — Pickup Sierra 1500	05-07 T			Monroe® Reflex® Camionetas Ligeras Amortiguador	
	01-03 T	<b>911187</b>	(Pág. 59)	Dodge — Pickup Ram 1500	06-08 T
GMC — Pickup Sierra 2500	99-10 T	Monroe® Reflex® Camionetas Ligeras Amortiguador		Dodge — Pickup Ram 2500	03-13 T
<b>911166</b>	(Pág. 43-46, 83)	<b>911190</b>	(Pág. 40, 82)	Dodge — Pickup Ram 3500	03-12 T
Monroe® Reflex® Camionetas Ligeras Amortiguador		Monroe® Reflex® Camionetas Ligeras Amortiguador		RAM — Serie 2500	10-13 T
Chevrolet — Sonora	01-06 T	Chevrolet — Pickup K y V	87-00 D	<b>911223</b>	(Pág. 59-60)
Chevrolet — Suburban	95-06 T	GMC — Pickup Series C, R, K y V	87-00 D	Monroe® Reflex® Camionetas Ligeras Amortiguador	
Chevrolet — Tahoe	01-06 T			Dodge — Pickup Ram 2500	03-13 D
GMC — Yukon	01-06 T	<b>911191</b>	(Pág. 59-60)	Dodge — Pickup Ram 3500	03-13 D
<b>911168</b>	(Pág. 42, 45, 81)	Monroe® Reflex® Camionetas Ligeras Amortiguador		<b>911228</b>	(Pág. 35, 79)
Monroe® Reflex® Camionetas Ligeras Amortiguador		Dodge — Pickup Ram 2500	94-02 D	Monroe® Reflex® Camionetas Ligeras Amortiguador	
Chevrolet — Pickup Silverado	01-10 T	Dodge — Pickup Ram 3500	94-02 D	Chevrolet — Colorado Pickup	04-12 T
Chevrolet — Suburban	00-13 T	<b>911192</b>	(Pág. 59-60)	GMC — Canyon Pickup	04-12 T
GMC — Pickup Sierra 3500	01-10 T	Monroe® Reflex® Camionetas Ligeras Amortiguador		<b>911229</b>	(Pág. 35, 79)
<b>911173</b>	(Pág. 65, 72-73)	Dodge — Pickup Ram 2500	94-02 T	Monroe® Reflex® Camionetas Ligeras Amortiguador	
Monroe® Reflex® Camionetas Ligeras Amortiguador		Dodge — Pickup Ram 3500	94-02 T	Chevrolet — Colorado Pickup	04-12 D
Ford — Excursion	00-05 D	<b>911193</b>	(Pág. 59-60)	GMC — Canyon Pickup	04-12 D
Ford — Pickup Serie F-250	99-16 D	Monroe® Reflex® Camionetas Ligeras Amortiguador		<b>911230</b>	(Pág. 35, 79)
Ford — Pickup Serie F-350	99-16 D	Dodge — Pickup Ram 2500	94-02 D	Monroe® Reflex® Camionetas Ligeras Amortiguador	
<b>911174</b>	(Pág. 65)	Dodge — Pickup Ram 3500	94-02 D	Chevrolet — Colorado Pickup	04-12 T
Monroe® Reflex® Camionetas Ligeras Amortiguador		<b>911194</b>	(Pág. 72-73)	GMC — Canyon Pickup	04-12 T
Ford — Excursion	00-05 T	Monroe® Reflex® Camionetas Ligeras Amortiguador		<b>911255</b>	(Pág. 47)
<b>911175</b>	(Pág. 65)	Ford — Pickup Serie F-250	99-04 T	Monroe® Reflex® Camionetas Ligeras Amortiguador	
Monroe® Reflex® Camionetas Ligeras Amortiguador		Ford — Pickup Serie F-350	99-04 T	Chevrolet — Van 1500 Express, Savana, Modelos G y P	03-14 D
Ford — Excursion	00-05 D	<b>911196</b>	(Pág. 73-74)	<b>911256</b>	(Pág. 47)
<b>911176</b>	(Pág. 65)	Monroe® Reflex® Camionetas Ligeras Amortiguador		Monroe® Reflex® Camionetas Ligeras Amortiguador	
Monroe® Reflex® Camionetas Ligeras Amortiguador		Ford — Pickup Serie F-250	99-04 T	Chevrolet — Van 1500 Express, Savana, Modelos G y P	03-14 D
Ford — Excursion	00-05 T	Ford — Pickup Serie F-350	99-04 T	<b>911257</b>	(Pág. 47-48)
<b>911178</b>	(Pág. 43, 44-46, 83)	<b>911197</b>	(Pág. 59)	Monroe® Reflex® Camionetas Ligeras Amortiguador	
Monroe® Reflex® Camionetas Ligeras Amortiguador		Monroe® Reflex® Camionetas Ligeras Amortiguador		Chevrolet — Van 1500 Express, Savana, Modelos G y P	03-18 D
Chevrolet — Sonora	01-06 D	Dodge — Pickup Ram 1500	13-17 T	<b>911258</b>	(Pág. 36, 116)
Chevrolet — Suburban	95-06 D	<b>911198</b>	(Pág. 59-60)	Monroe® Reflex® Camionetas Ligeras Amortiguador	
Chevrolet — Tahoe	01-06 D	Monroe® Reflex® Camionetas Ligeras Amortiguador		Chevrolet — Equinox	05-17 TD
GMC — Yukon	01-06 D	Dodge — Pickup Ram 2500	14-16 D	Pontiac — Torrent	06-09 TD
<b>911181</b>	(Pág. 32, 41-42, 44-45, 79-81)	<b>911220</b>	(Pág. 56-57)		
Monroe® Reflex® Camionetas Ligeras Amortiguador		Monroe® Reflex® Camionetas Ligeras Amortiguador			
Chevrolet — Avalanche	02-06 D	Dodge — Dakota	97-04 D		
Chevrolet — Pickup Silverado	99-10 D	Dodge — Durango	98-03 D		
Chevrolet — Suburban	00-13 D				
GMC — Pickup Sierra 1500	05-07 D				
	01-03 D				
GMC — Pickup Sierra 2500	99-10 D				

Números de parte con P (P--) indican accesorios con la unidad



# PROGRESIVO AMORTIGUADORES

## INDICE PROGRESIVO DE APLICACIONES

Vehículo	Años Pos.	Vehículo	Años Pos.	Vehículo	Años Pos.
<b>911259</b>	(Pág. 53, 57)	<b>911300</b>	(Pág. 58, 117)	<b>911506 (Cont.)</b>	(Pág. 31-32, 43-46, 83)
Monroe® Reflex® Camionetas Ligeras Amortiguador		Monroe® Reflex® Camionetas Ligeras Amortiguador		Monroe® Reflex® Monotubo Amortiguador	
Dodge — Aspen	06-09 D	Dodge — Pickup Ram 1500	09-10 D	Chevrolet — Avalanche	02-13 T
Dodge — Durango	04-09 D	RAM — Serie 1500	11-18 D	Chevrolet — Suburban	00-18 T
<b>911260</b>	(Pág. 53, 57)	<b>911302</b>	(Pág. 72)	Chevrolet — Tahoe	07-18 T
Monroe® Reflex® Camionetas Ligeras Amortiguador		Monroe® Reflex® Camionetas Ligeras Amortiguador		GMC — Yukon	01-14 T
Dodge — Aspen	06-09 T	Ford — Pickup Serie F-100, F-150, Lobo	09-13 T	<b>911507</b>	(Pág. 87)
Dodge — Durango	04-09 T	<b>911303</b>	(Pág. 42, 81)	Monroe® Reflex® Monotubo Amortiguador	
<b>911261</b>	(Pág. 71, 98)	Monroe® Reflex® Camionetas Ligeras Amortiguador		Hummer — Hummer	03-09 D
Monroe® Reflex® Camionetas Ligeras Amortiguador		Chevrolet — Pickup Silverado	11-18 T	<b>911508</b>	(Pág. 87)
Ford — Pickup Serie F-100, F-150, Lobo	04-08 T	<b>911304</b>	(Pág. 57, 92-93)	Monroe® Reflex® Monotubo Amortiguador	
Lincoln — Pickup Mark LT	06-08 T	Monroe® Reflex® Camionetas Ligeras Amortiguador		Hummer — Hummer	03-09 T
<b>911262</b>	(Pág. 72, 99)	Dodge — Durango	11-15 T	<b>911511</b>	(Pág. 39, 45, 82)
Monroe® Reflex® Camionetas Ligeras Amortiguador		Jeep — Grand Cherokee	11-15 T	Monroe® Reflex® Monotubo Amortiguador	
Ford — Pickup Serie F-100, F-150, Lobo	04-08 T	<b>911330</b>	(Pág. 66)	Chevrolet — Pickup K y V	87-99 D
Lincoln — Pickup Mark LT	06-08 T	Monroe® Reflex® Camionetas Ligeras Amortiguador		Chevrolet — Suburban	92-99 D
<b>911265</b>	(Pág. 72-73)	Ford — Explorer	11-19 TD	GMC — Pickup Series C, R, K y V	87-99 D
Monroe® Reflex® Camionetas Ligeras Amortiguador			11-19 TI	<b>911512</b>	(Pág. 39, 82)
Ford — Pickup Serie F-250	05-16 T	<b>911331</b>	(Pág. 71)	Monroe® Reflex® Monotubo Amortiguador	
Ford — Pickup Serie F-350	05-16 T	Monroe® Reflex® Camionetas Ligeras Amortiguador		Chevrolet — Blazer	94-03 D
<b>911266</b>	(Pág. 73-74)	Ford — Pickup Serie F-100, F-150, Lobo	09-13 T	Chevrolet — S-10	83-05 D
Monroe® Reflex® Camionetas Ligeras Amortiguador		<b>911447</b>	(Pág. 42, 81)	GMC — Sonoma 2WD	94-03 D
Ford — Pickup Serie F-250	05-19 D	Monroe® Reflex® Camionetas Ligeras Amortiguador		<b>911517</b>	(Pág. 43)
Ford — Pickup Serie F-350	05-19 D	Chevrolet — Pickup Silverado	11-18 D	Monroe® Reflex® Monotubo Amortiguador	
<b>911267</b>	(Pág. 73-74)	<b>911501</b>	(Pág. 41-42, 80-81)	Chevrolet — S-10	83-05 T
Monroe® Reflex® Camionetas Ligeras Amortiguador		Monroe® Reflex® Monotubo Amortiguador		<b>911527</b>	(Pág. 88)
Ford — Pickup Serie F-250	05-16 T	Chevrolet — Pickup Silverado	99-07 D	Monroe® Reflex® Monotubo Amortiguador	
Ford — Pickup Serie F-350	05-07 T	GMC — Pickup Sierra 1500	99-07 D	Hummer — Hummer	06-10 D
<b>911268</b>	(Pág. 74)	<b>911502</b>	(Pág. 41-42, 80-81)	<b>911528</b>	(Pág. 88)
Monroe® Reflex® Camionetas Ligeras Amortiguador		Monroe® Reflex® Monotubo Amortiguador		Monroe® Reflex® Monotubo Amortiguador	
Ford — Pickup Serie F-350	05-16 T	Chevrolet — Pickup Silverado	99-07 T	Hummer — Hummer	06-10 T
<b>911277</b>	(Pág. 56)	GMC — Pickup Sierra 1500	99-07 T	<b>911530</b>	(Pág. 107)
Monroe® Reflex® Camionetas Ligeras Amortiguador		<b>911503</b>	(Pág. 41, 80)	Monroe® Reflex® Monotubo Amortiguador	
Dodge — Dakota	05-12 T	Monroe® Reflex® Monotubo Amortiguador		Nissan — Frontier Pickup	98-04 T
<b>911278</b>	(Pág. 92, 93)	Chevrolet — Pickup Silverado	99-07 D	<b>911533</b>	(Pág. 40-41, 79-80)
Monroe® Reflex® Camionetas Ligeras Amortiguador		GMC — Pickup Sierra 1500	99-07 D	Monroe® Reflex® Monotubo Amortiguador	
Jeep — Commander	06-10 T	<b>911504</b>	(Pág. 41, 80)	Chevrolet — Pickup Silverado	07-18 T
Jeep — Grand Cherokee	05-10 T	Monroe® Reflex® Monotubo Amortiguador		GMC — Pickup Sierra 1500	07-18 T
<b>911299</b>	(Pág. 58-59, 117)	Chevrolet — Pickup Silverado	99-07 T	<b>911536</b>	(Pág. 94)
Monroe® Reflex® Camionetas Ligeras Amortiguador		GMC — Pickup Sierra 1500	99-07 D	Monroe® Reflex® Monotubo Amortiguador	
Dodge — Pickup Ram 1500	09-18 T	<b>911505</b>	(Pág. 31-32, 44-45, 83)	Jeep — Wrangler	07-18 D
RAM — Serie 1500	11-18 T	Monroe® Reflex® Monotubo Amortiguador		<b>911538</b>	(Pág. 94)
		Cadillac — Escalade	02-06 D	Monroe® Reflex® Monotubo Amortiguador	
		Chevrolet — Avalanche	02-06 D	Jeep — Wrangler	07-15 T
		Chevrolet — Suburban	00-06 D	<b>MA726</b>	(Pág. 71, 78)
		GMC — Yukon	01-06 D	Monroe® Max-Air® Aire Amortiguador	
		<b>911506</b>	(Pág. 31-32, 43-46, 83)	Ford — Pickup Serie F-100, F-150, Lobo	85-96 T
		Monroe® Reflex® Monotubo Amortiguador		Ford — Van Serie E	75-91 T
		Cadillac — Escalade	02-06 T		

Números de parte con P (P--) indican accesorios con la unidad



# PROGRESIVO AMORTIGADORES

## INDICE PROGRESIVO DE APLICACIONES

Vehículo	Años Pos.	Vehículo	Años Pos.	Vehículo	Años Pos.
<b>MA759</b>	(Pág. 32-33)	<b>MW004</b>	(Pág. 34, 38)	<b>MW872</b>	(Pág. 111-112)
Monroe® Max-Air® Aire Amortiguador		Monroe® Monro-Matic Hidraulico Strut		Monroe® Monro-Matic Hidraulico Strut	
Chevrolet — Blazer	83-05 T	Chevrolet — Chevy Pickup	93-05 D	Nissan — Tsubame	93-04 DI
<b>MA773</b>	(Pág. 71)	Chevrolet — Chevy, Chevy Joy, Pop y Swing	93-12 D	Nissan — Tsuru	92-17 DI
Monroe® Max-Air® Aire Amortiguador		Chevrolet — Meriva	03-08 DD	<b>MW873</b>	(Pág. 112)
Ford — Pickup Serie F-100, F-150, Lobo	80-84 T	Chevrolet — Monza	03-08 DI	Monroe® Monro-Matic Hidraulico Strut	
<b>MA780</b>	(Pág. 31)		93-12 D	Nissan — Tsuru	92-17 TD
Monroe® Max-Air® Aire Amortiguador		<b>MW005</b>	(Pág. 136)	<b>MW874</b>	(Pág. 112)
Cadillac — Seville	76-79 T	Monroe® Monro-Matic Hidraulico Strut		Monroe® Monro-Matic Hidraulico Strut	
<b>MA785</b>	(Pág. 35)	Volkswagen — Pointer	98-09 T	Nissan — Tsuru	92-17 TI
Monroe® Max-Air® Aire Amortiguador		<b>MW009</b>	(Pág. 119, 134)	<b>MW933</b>	(Pág. 135-136)
Chevrolet — Corvette	62-82 T	Monroe® Monro-Matic Hidraulico Strut		Monroe® Monro-Matic Hidraulico Strut	
<b>MA812</b>	(Pág. 109)	Seat — Cordoba	99-02 D	Volkswagen — Golf A3	93-98 D
Monroe® Max-Air® Aire Amortiguador		Seat — Ibiza	01-02 D	Volkswagen — Jetta A3	93-98 D
Nissan — Pickup	95-97 T	Volkswagen — Derby	99-09 D	<b>SA1930</b>	(Pág. 64, 72-74)
<b>MA824</b>	(Pág. 47-48, 115)	Volkswagen — Derby Van	02-07 D	Monroe® Magnum™ Amortiguador de Dirección	
Monroe® Max-Air® Aire Amortiguador		<b>MW013</b>	(Pág. 119, 134)	Ford — Bronco	80-96 D
Chevrolet — Uplander	05-09 T	Monroe® Monro-Matic Hidraulico Strut		Ford — Pickup Serie F-100, F-150, Lobo	80-96 D
Chevrolet — Venture (Mini Van) AWD	97-05 T	Seat — Cordoba	99-02 T	Ford — Pickup Serie F-250	80-96 D
Pontiac — Aztek AWD	01-05 T	Seat — Ibiza	01-02 T	Ford — Pickup Serie F-350	80-97 D
<b>MA828</b>	(Pág. 41, 80)	Volkswagen — Derby	99-09 T	<b>SA1932</b>	(Pág. 39, 61-62)
Monroe® Max-Air® Aire Amortiguador		<b>MW014</b>	(Pág. 136)	Monroe® Magnum™ Amortiguador de Dirección	
Chevrolet — Pickup Silverado	99-07 T	Monroe® Monro-Matic Hidraulico Strut		Chevrolet — Pickup C y R	60-91 D
GMC — Pickup Sierra 1500	99-07 T	Volkswagen — Pointer Pickup	98-10 T	Dodge — Pickup D y W	72-93 D
<b>MA829</b>	(Pág. 71)	<b>MW016</b>	(Pág. 114)	<b>SC2911</b>	(Pág. 92)
Monroe® Max-Air® Aire Amortiguador		Monroe® Monro-Matic Hidraulico Strut		Monroe® Magnum™ Amortiguador de Dirección	
Ford — Pickup Serie F-100, F-150, Lobo	97-03 T	Peugeot — 206	99-09 D	Jeep — Cherokee	74-83 D
<b>MA833</b>	(Pág. 29, 47)	<b>MW202</b>	(Pág. 133-134)	<b>SC2912</b>	(Pág. 62, 64, 72-74)
Monroe® Max-Air® Aire Amortiguador		Monroe® Monro-Matic Hidraulico Strut		Monroe® Magnum™ Amortiguador de Dirección	
Buick — Enclave	08-17 T	Volkswagen — Atlantic	81-87 T	Dodge — Pickup D y W	89-93 D
Chevrolet — Traverse	09-17 T	Volkswagen — Cabriolet	85-93 T	Ford — Bronco	80-96 D
<b>MA834</b>	(Pág. 40-41, 79-80)	Volkswagen — Caribe	77-87 T	Ford — Pickup Serie F-100, F-150, Lobo	80-96 D
Monroe® Max-Air® Aire Amortiguador		<b>MW265</b>	(Pág. 135-136)	Ford — Pickup Serie F-250	80-96 D
Chevrolet — Pickup Silverado	07-18 T	Monroe® Monro-Matic Hidraulico Strut		Ford — Pickup Serie F-350	80-97 D
GMC — Pickup Sierra 1500	07-18 T	Volkswagen — Golf A2	85-91 T	<b>SC2913</b>	(Pág. 33, 48)
<b>MA835</b>	(Pág. 71)	Volkswagen — Golf A3	93-98 T	Monroe® Magnum™ Amortiguador de Dirección	
Monroe® Max-Air® Aire Amortiguador		Volkswagen — Jetta A2	85-91 T	Chevrolet — Blazer	73-91 D
Ford — Pickup Serie F-100, F-150, Lobo	09-13 T	Volkswagen — Jetta A3	93-98 T	Chevrolet — Van 1500 Express, Savana, Modelos G y P	93-96 D
<b>MA836</b>	(Pág. 72)	<b>MW815</b>	(Pág. 112)	<b>SC2914</b>	(Pág. 45)
Monroe® Max-Air® Aire Amortiguador		Monroe® Monro-Matic Hidraulico Strut		Monroe® Magnum™ Amortiguador de Dirección	
Ford — Pickup Serie F-100, F-150, Lobo	09-13 T	Nissan — Tsuru	88-91 DD	Chevrolet — Suburban	92-99 D
<b>MA837</b>	(Pág. 58-59, 117)		88-91 DI	<b>SC2915</b>	(Pág. 39, 62)
Monroe® Max-Air® Aire Amortiguador		<b>MW816</b>	(Pág. 112)	Monroe® Magnum™ Amortiguador de Dirección	
Dodge — Pickup Ram 1500	02-18 T	Monroe® Monro-Matic Hidraulico Strut		Chevrolet — Pickup C y R	60-91 D
RAM — Serie 1500	11-18 T	Nissan — Tsuru	88-91 TI	Dodge — Pickup D y W	72-88 D
<b>MC888</b>	(Pág. 136)	<b>MW817</b>	(Pág. 112)		
Monroe® Monro-Matic Hidraulico Suspension Strut Cartridge		Monroe® Monro-Matic Hidraulico Strut			
Volkswagen — Pointer	98-09 D	Nissan — Tsuru	88-91 TD		
Volkswagen — Pointer Pickup	98-10 D	<b>MW853</b>	(Pág. 135-136)		
		Monroe® OESpectrum® Strut			
		Volkswagen — Golf A2	85-91 D		
		Volkswagen — Jetta A2	85-91 D		
		<b>MW871</b>	(Pág. 111-112)		
		Monroe® Monro-Matic Hidraulico Strut			
		Nissan — Tsubame	93-04 DD		
		Nissan — Tsuru	92-17 DD		

Números de parte con P (P--) indican accesorios con la unidad



# PROGRESIVO AMORTIGUADORES

## INDICE PROGRESIVO DE APLICACIONES

Vehículo	Años Pos.	Vehículo	Años Pos.	Vehículo	Años Pos.
<b>SC2916</b>	(Pág. 40, 62)	<b>SC2948</b>	(Pág. 91)	<b>SC2963</b>	(Pág. 32, 42, 82)
Monroe® Magnum™ Amortiguador de Dirección		Monroe® Magnum™ Amortiguador de Dirección		Monroe® Magnum™ Amortiguador de Dirección	
Chevrolet — Pickup K y V	70-72 D	Isuzu — Amigo	89-94 D	Chevrolet — Avalanche	02-06 D
Dodge — Pickup D y W	72-93 D	Isuzu — Rodeo	90-96 D	Chevrolet — Pickup Silverado	00-10 D
Dodge — Ramcharger	74-93 D	<b>SC2953</b>	(Pág. 59-61)	<b>SC2964</b>	(Pág. 59-61)
<b>SC2917</b>	(Pág. 40, 45, 62, 72, 73, 82, 83, 92)	Monroe® Magnum™ Amortiguador de Dirección		Monroe® Magnum™ Amortiguador de Dirección	
Monroe® Magnum™ Amortiguador de Dirección		Dodge — Pickup Ram 1500	94-97 D	Dodge — Pickup Ram 1500	00-07 D
Chevrolet — Pickup K y V	60-69 D	Dodge — Pickup Ram 2500	94-97 D	Dodge — Pickup Ram 2500	00-07 D
Chevrolet — Suburban	60-69 D	Dodge — Pickup Ram 3500	94-97 D	Dodge — Pickup Ram 3500	00-07 D
Dodge — Pickup D y W	59-79 D	<b>SC2954</b>	(Pág. 128)	<b>SC2965</b>	(Pág. 75)
Ford — Pickup Serie F-100, F-150, Lobo	59-65 D	Monroe® Magnum™ Amortiguador de Dirección		Monroe® Magnum™ Amortiguador de Dirección	
Ford — Pickup Serie F-250	59-77 D	Toyota — Pickup T100	93-98 D	Ford — Pickup Serie F-450	05-07 D
GMC — Pickup Series C, R, K y V	60-69 D	<b>SC2955</b>	(Pág. 73, 75)	Ford — Pickup Serie F-550	05-07 D
Jeep — CJ	72-79 D	Monroe® Magnum™ Amortiguador de Dirección		<b>SC2966</b>	(Pág. 61, 117)
<b>SC2928</b>	(Pág. 92-94)	Monroe® Magnum™ Amortiguador de Dirección		Monroe® Magnum™ Amortiguador de Dirección	
Monroe® Magnum™ Amortiguador de Dirección		Ford — Pickup Serie F-250	92-07 D	Dodge — Pickup Ram 4500	08-10 D
Jeep — Cherokee	84-01 D	Ford — Pickup Serie F-350	92-07 D	Dodge — Pickup Ram 5500	08-10 D
Jeep — Grand Cherokee	83-98 D	<b>SC2956</b>	(Pág. 42)	RAM — Serie 2500	11-17 D
Jeep — Wrangler	87-06 D	Monroe® Magnum™ Amortiguador de Dirección		<b>SC2967</b>	(Pág. 73-74)
<b>SC2937</b>	(Pág. 33)	Chevrolet — Pickup Silverado	92-96 D	Monroe® Magnum™ Amortiguador de Dirección	
Monroe® Magnum™ Amortiguador de Dirección		<b>SC2957</b>	(Pág. 128)	Ford — Pickup Serie F-250	08-16 D
Chevrolet — Blazer	83-05 D	Monroe® Magnum™ Amortiguador de Dirección		Ford — Pickup Serie F-350	08-16 D
<b>SC2940</b>	(Pág. 92)	Toyota — Land Cruiser	95-98 D	<b>SC2968</b>	(Pág. 60-61)
Monroe® Magnum™ Amortiguador de Dirección		<b>SC2958</b>	(Pág. 67)	Monroe® Magnum™ Amortiguador de Dirección	
Jeep — Cherokee	74-83 D	Monroe® Magnum™ Amortiguador del Eje		Dodge — Pickup Ram 2500	09-13 D
Jeep — CJ	73-86 D	Ford — Explorer	95-00 D	Dodge — Pickup Ram 3500	09-13 D
<b>SC2942</b>	(Pág. 40)	<b>SC2960</b>	(Pág. 59-61)	<b>SC2969</b>	(Pág. 42, 81)
Monroe® Magnum™ Amortiguador de Dirección		Monroe® Magnum™ Amortiguador de Dirección		Monroe® Magnum™ Amortiguador de Dirección	
Chevrolet — Pickup K y V	87-99 D	Dodge — Pickup Ram 1500	97-99 D	Chevrolet — Pickup Silverado	11-16 D
<b>SC2946</b>	(Pág. 128)	Dodge — Pickup Ram 2500	97-99 D	GMC — Pickup Sierra 2500	11-15 D
Monroe® Magnum™ Amortiguador de Dirección		Dodge — Pickup Ram 3500	97-99 D	GMC — Pickup Sierra 3500	11-15 D
Toyota — Land Cruiser	80-95 D	<b>SC2961</b>	(Pág. 73, 75)	<b>SC2970</b>	(Pág. 94)
<b>SC2947</b>	(Pág. 123, 128)	Monroe® Magnum™ Amortiguador de Dirección		Monroe® Magnum™ Amortiguador de Dirección	
Monroe® Magnum™ Amortiguador de Dirección		Ford — Pickup Serie F-250	99-04 D	Jeep — Wrangler	10-18 D
Toyota — 4 Runner	86-96 D	Ford — Pickup Serie F-350	99-04 D	<b>SC2973</b>	(Pág. 117)
Toyota — Pickup Compact	86-95 D	Ford — Pickup Serie F-450	99-04 D	Monroe® Magnum™ Amortiguador de Dirección	
		Ford — Pickup Serie F-550	99-04 D	RAM — Serie 2500	13-19 D
		<b>SC2962</b>	(Pág. 61, 93)		
		Monroe® Magnum™ Amortiguador de Dirección			
		Jeep — Grand Cherokee	99-04 D		

Números de parte con P (P--) indican accesorios con la unidad

# MONROE

AMORTIGUADORES



## CATÁLOGO 2023



# TABLA DE MEDIDAS

\*Longitudes en pulgadas

Número de Parte	Códigos de Montura		Longitudes			Accesorios
	Sup.	Inf.	Comprimida	Extendida	Viaje	
<b>AMORTIGUADORES</b>						
1000	L1	L1	11.97	19.41	7.44	P411
1089	LS23	LS23	10.375	16.25	5.875	P110
1195	LS27	LS45	10.33	14.29	3.96	Ninguno
1401	S4	XP5	8.95	13.38	4.43	P1134
1406	S4	LS26	9.97	14.59	4.62	P1135
1407	L1	LS25	14.31	23.01	8.7	Ninguno
1408	S4	LS23	8.38	12.57	4.19	P1137
1409	L1	S4	11.62	18.82	7.2	P1134
1412	L1	L1	13.19	21.04	7.85	P573
1414	L1	LS36	9.94	14.63	4.69	P19
1415	L1	LS47	14.06	22.88	8.82	P19
1419	S4	LS38	9.85	14.98	5.13	P1135
1420	S4	LS38	10.62	16.48	5.86	P1135
1538	S4	LS23	13.35	16.87	3.52	P1137, P124
2545	LS23	LS23	13.59	22.66	9.07	P110
2592	LS27	LS27	16.18	10.59	5.59	P110
3116	S4	LS23	13	21.32	8.32	P1137
3147	S4	LS15	10.97	17.59	6.62	Ninguno
3155	LS5	LS5	10.83	17.28	6.45	Ninguno
5502	S5	LS33	13.33	21.87	6.25	P01637
5504	S4	LS27	18.36	22.05	3.76	P01744
5505	S4	LS27	18.09	21.55	3.46	P01744
5506	S1		16.99	27.26	10.27	Ninguno
5507	S1		16.54	24.84	8.3	M17110497
5509	S1		15.35	23.35	8	Ninguno
5510	LS30		9.84	14.02	4.18	Ninguno
5511	S7	LS27	16.48	26.38	9.9	Ninguno
5512	S1	XP4	12.15	18.22	6.07	P00857, P01431
5513	S2	LS43	14.35	22.34	7.99	P01524
5514	S15	LS43	17.04	24.35	7.31	P01505
5515	S8	LS57	16.35	25.83	9.48	P01682
5516	S2	SPEC	14.77	17.87	3.1	P00838
5517	S2	SPEC	14.77	17.87	3.1	P00838
5518	S1	LS42	15.08	24.88	9.83	P01505
5520	S1	LS31	15.57	25.63	10.06	P01431
5521	S4	LS43	11.44	17.83	6.39	P01417
5522	S1	LS44	14.466	21.023	6.457	P01699
5525	S42	LS27	17.84	20.35	2.51	P01744
5527	S1	LS42	13.74	23.02	9.28	P01505
5528	S1	LS42	13.74	23.02	9.28	P01505
5529	S1	LS42	13.74	23.32	9.58	P01505
5530	S1	LS65	16.89	26.46	9.37	P01682
5532	S4	LS28	18.72	20.23	1.51	P01136
5533			16.7	26.41		P01699

Número de Parte	Códigos de Montura		Longitudes			Accesorios
	Sup.	Inf.	Comprimida	Extendida	Viaje	
<b>AMORTIGUADORES</b>						
5534	LS27	LS45	10.33	14.29		Ninguno
5536			14.45	22.68		M17111088
5537	S15	LS5	14.27	21.86	7.59	P01431
5538	S15	LS31	15.41	23.15	7.74	P01431
5539	S15	LS96	13.788	20.409	6.621	P01698
5540	S1	LS29	16.34	25.76	9.42	P01682
5541	S1	LS32	14.64	23.46	8.82	P01603
5543	S15	LS96	14.263	20.188	5.925	P01698
5544	S2	LS53	12.84	19.58	6.73	P00839
5545	S1	LS43	15.92	25.98	10.06	P00906
5546	S8	LS100	16.76	26.45	9.65	P01682
5547	S15	LS101	13.3	20.87	7.57	P01431
5549	S15	LS5	14.17	19.34	5.17	Ninguno
5550	S15	LS6	15.43	23.5	8.07	P01743
5551	S1	LS45	17.93	25.83	7.56	P00906
5552	S15	CLEV	16.54	23.83	7.29	P01488
5553	S1	LS7	14.68	23.5	8.83	P01505
5555	S2	LS53	12.76	19.5	6.73	P00839
5556	S8	LS91	16.38	25.47	9.09	P01682
5558	S4	LS26	14.88	23.86	8.98	P01134
5559	S1	LS43	16.6	26.12	9.52	P00906
5560	S7	LS25	20.23	28.27	8.04	P01682
5561	S1	LS27	14.55	23.97	9.42	P01431
5562	S1	LS32	15.41	23.76	8.35	P00906
5566	S4	LS6	18.65	23.57	4.92	P01136
5600	S1	SPEC	14.66	21.42	6.76	P00906
5601	S4	LS50	16.16	25.91	9.75	P01511
5602	S4	SPEC	11.34	16.97	5.63	P01136
5603	S4	SPEC	11.34	16.34	5	P01136
5604	S6	LS15	15.78	23.46	7.68	Ninguno
5605	S4	LS7	17.1	21.03	3.93	P01136
5606	LS52	LS52	10.66	14.92	4.26	Ninguno
5607	SPEC	LS31	18.76	26.39	7.63	BE17110773
5608	S1	LS1	18.43	26.9	8.47	Ninguno
5609	S4	LS27	18.3	22.05	3.76	P01744
5611	S1	LS42	14.724	22.992	8.268	BE17110722
5612	S4	LS30	18.92	25.55	6.63	P01722
5613	S1	LS7	17.992	26.248	8.256	BE17110497
5614	S1	LS50	16.697	22.937	6.24	P00906
5615	S1	SPEC	14.003	21.59	5.587	P00906
5616	S1	S1	16.02	22	5.98	BE17110813
5617	SPEC	LS37	18.5	27.6	9.1	BE17110773
5618	S4	LS78	10.72	17.16	6.44	P01603
5621	S4	LS32	14.95	23.79	8.84	P01603





# TABLA DE MEDIDAS

\*Longitudes en pulgadas

Número de Parte	Códigos de Montura		Longitudes			Accesorios
	Sup.	Inf.	Comprimida	Extendida	Viaje	
<b>AMORTIGUADORES</b>						
5622	S1	SPEC	13.389	21.342	7.953	P00906
5624	S4	SPEC	15.5	24.5	9	P01136
5626	S4	LS16	17.688	21.5	3.812	P01136
5629	S4	LS30	18.125	25.3125	7.188	P01722
5630	LS38	SPEC	17.12	26.38	9.26	Ninguno
5631	S1	CLEV	14.25	21.875	7.625	P01488
5637	SPEC	S1	16.54	20.95	4.44	P01488
5639	SPEC	LS29	12.82	18	5.18	Ninguno
5645	S7	LS24	18.665	27.913	9.248	Ninguno
5646	S1	CLEV	14.56	21.33	6.77	P01523
5647	S1	LS38	14.69	22.29	7.6	P01431
5648	S5	CLEV	16.97	23.13	6.16	P01637,P00590
5652	LS23	LS23	10.48	15.92		Ninguno
5654	S34	CLEV	16.19	20.53	4.34	P01720
5656	LS27	LS43	12.98	20.83	7.85	Ninguno
5657	LS26	LS31	10	14.79	4.46	Ninguno
5658	S4	LS28	17.55	22.86	5.31	P01136
5659	S1	SPEC	16.46	20.87	4.41	P01488
5660	S15	LS43	14.56	23.95	9.39	BE17110779
5661	LS23	LS23	11.220	17.512	6.291	Ninguno
5662	S1	LS102	14.04	22.29	8.25	P01431
5663	S1	LS43	15.8	25.64	9.64	P01431
5664	S1	LS65	14.2	20.44	6.24	P01698
5666	S7	LS43	11.38	18.23	6.85	P01699
5667	S1	XP4	12.25	19.33	7.06	P00857,P00906
5668	LS30	LS92	10.6	16.16	5.56	Ninguno
5671	LS30	LS25	10.45	15.31	4.86	Ninguno
5672	LS30	LS25	9.95	14.31	4.36	Ninguno
5673	S4	LS28	18.4	23.1	4.69	P01136
5675	S6	LS6	15.64	23.75	8.11	P01136
5677	S1	LS27	15.16	23.43	8.27	BE17110294
5678	S7	LS25	13.79	20.58	6.79	Ninguno
5681	S1	S1	11.35	19.69	6.01	P00522
5682	S4	LS6	18.94	23.62	4.68	P01136
5683	S7	LS25	19.01	28.13	9.12	P01699
5684	S5	LS84	15.16	22.37	3.86	P01733
5685	S5	LS33	18	23.87	5.87	P01733
5687	S5	LS84	14.66	23.87	5.86	P01733
5688	LS35	S1	17.6	26.67	9.07	Ninguno
5689	S1	LS43	15.3	24.89	9.59	P01431
5695	LS25	LS25	10.31	15.1	4.79	Ninguno
5696	LS30	LS43	10.31	15.71	5.4	Ninguno
5697	S7	LS25	19.01	28.13	9.12	P01699
5698	S6	LS27	18.09	21.55	3.46	P01744

Número de Parte	Códigos de Montura		Longitudes			Accesorios
	Sup.	Inf.	Comprimida	Extendida	Viaje	
<b>AMORTIGUADORES</b>						
5699	S1	LS43	16.18	25.27	9.09	P01431
5751	S4	S4	8.5	13.44	4.94	(2) P01134
5752	L1	L1	8.625	12.75	4.125	Ninguno
5753	S4	L1	10.375	16.75	6.375	P01134
5754	S4	XP1	9.625	15.125	5.5	P01134
5756	S4	SP	10	15.5	5.5	P01137,P00423
5757	L1/CP3	L1/CP3	14	23.625	9.625	P00572, (2) P00576
5758	S4	S4	9.375	14.625	5.25	(2) P01134
5759	S4	XP12	9.375	14.875	5.5	P01137
5760	L1	LS14	14.625	24.875	10.25	Ninguno
5761	S4	L2	11.75	19	7.25	P01135
5762	L2	XP5	10.625	15.25	4.625	Ninguno
5763	S3	LS37	9.875	14.75	4.875	P00002
5765	SPEC	XP6	10.125	15.5	5.375	P00002
5766	XP7	L1	12.875	21.125	8.25	Ninguno
5772	S4	L2	12.625	20.75	8.125	P01135
5778	S4	LS47	11.5	17.875	6.375	P01417
5779	LS29	LS47	10.5	16.125	5.625	Ninguno
5780	LS29	LS47	11.5	17.75	6.25	Ninguno
5781	LS27	LS43	13.22	20.39	7.17	Ninguno
5783	S4	LS26	12.5	20	7.5	P01136
5784	LS38	LS38	11.22	17.57	6.35	Ninguno
5785	S5	LS5	10.59	17.48	6.89	Ninguno
5786	S1	LS45	15.625	27	11.375	P01479
5791	M10	L7	16.53	24.85	8.32	BE17110497
5792	LS28	LS26	13.61	16.35	2.74	Ninguno
5794	S4	SPEC	14.38	24.2	9.82	P01136
5795	S1	SPEC	14.28	20.05	5.77	P00906,P01488
5796	S4	LS25	15.72	24.68	8.96	P01134
5797	S4	LS30	18.1	25.3	7.2	P01722
5801	S4	XP5	9.25	14.375	5.125	P01134
5802	XP7	L1/CP3	12.75	20.875	8.125	P00576
5803	S4	L1/CP3	12.75	21.5	8.75	P00576,P01134
5809	S4	SP	9	13.625	4.625	P00423,P01136
5811	S4	LS15	8	12.25	4.25	P01134
5815	S4	LS19	8.75	13.25	4.5	P01134
5818	S4	L1/CP3	11.625	19.375	7.75	P00576,P01134
5819	S4	S4	9.25	14.125	4.875	(2) P01134
5820	XP7	L1/CP3	14.125	24	9.875	P00576
5821	S4	XP4	8	11.75	3.75	P01134
5827	S4	LS26	9.3	14.04	4.74	Ninguno
5829	S4	S4	7.125	10.75	3.625	(2) P01135
5831	XP7	S4	12.25	20.5	8.25	P01137
5837	LS39	S4	11.375	18.625	7.25	P01134



# TABLA DE MEDIDAS

\*Longitudes en pulgadas

Número de Parte	Códigos de Montura		Longitudes			Accesorios
	Sup.	Inf.	Comprimida	Extendida	Viaje	
<b>AMORTIGUADORES</b>						
5839	S4	L1/CP3	11.125	18.125	7	P00576,P01134
5840	S4	XP4	8.75	13.25	4.5	P01134
5843	LS48	LS47	10	12.875	2.875	Ninguno
5845	S4	LS26	12.25	20.125	7.875	P01136
5847	S4	L1/CP3	12.375	20.5	8.125	P00576,P01136
5850	LS14	L1	9.5	14	4.5	Ninguno
5861	S4	LS26	14.75	23.75	9	P01136
5867	S4	L1/CP3	11.75	19	7.25	P01134,P00576
5868	LS38	LS30	11.5	17.5	6	Ninguno
5870	S4	L1	14.25	23.875	9.625	P01137
5877	LS33	LS23	10.375	15.875	5.5	Ninguno
5892	S4	XP7	10.5	13.75	3.25	P01134
5893	LS40	LS52	9.375	14.25	4.875	Ninguno
5896	S4	LS4	13.125	22.125	9	P01134
5897	S4	LS7	16.125	21.25	5.125	P01134
5906	S4	XP5	9.375	14.625	5.25	P01134
5921	XP7	LS4	8.75	12.375	3.625	Ninguno
5928	S4	LS83	14.375	24	9.625	P01134
5930	LS32	LS32	11.875	18.375	6.5	Ninguno
5931	XP7	LS14	18.875	21.25	2.375	P00436
5939	S4	LS52	9.625	14.875	5.25	P01134
5947	S1	LS74	14.375	21.75	7.375	P01180
5948	LS7	LS7	14	22.75	8.75	Ninguno
5955	XP7	L1/CP3	13.125	21.25	8.125	P00576
5960	S4	XP4	9.125	13.75	4.625	P01136
5961	S4	L1/CP3	12.125	20	7.875	P01136,P00576
5962	LS7	LS7	13.375	21.5	8.125	Ninguno
5965	S4	LS47	14.5	19.125	4.625	P01136
5966	XP7	L1/CP3	13.125	21.25	8.125	P00576,P00941
5967	S4	L1/CP3	12.125	19.625	7.5	P01136,P00576
5968	S4	LS26	14.5	19.125	4.625	P01136
5969	S4	XP4	9.125	13.75	4.625	P01136
5970	S4	SPEC	11.375	18.625	7.25	P01180,P01181
5971	S4	SPEC	15	21	6	P01401,P01136
5974	S1	LS74	15.125	24	8.875	BE17110294
5975	S1	LS43	10.5	17	6.5	BE17110308
5981	S1	LS27	14.375	23.625	9.25	BE17110294
5984	S1	LS7	16.5	25.75	9.25	Ninguno
5986	LS97	LS25	12.875	17.875	5	Ninguno
5988	S1	LS27	14.375	24.125	9.75	BE17110294
5989	LS33	LS28	11.75	18.125	6.375	Ninguno
5990	S1	SPEC	14.625	21.125	6.5	P00906
5992	S1	LS48	15.375	24.5	9.125	BE17110507
5993	S4	LS74	12.5	21.25	8.75	P01136

Número de Parte	Códigos de Montura		Longitudes			Accesorios
	Sup.	Inf.	Comprimida	Extendida	Viaje	
<b>AMORTIGUADORES</b>						
5996	S1	LS7	16.875	25.125	8.25	BE17110497
5998	S1	LS27	14.625	23.5	8.875	BE17110294
5999	S1	LS31	13.75	21	7.25	BE17110496
31000	L1	L1	12	19.5	7.5	P00411
31029	S4	L1	9.625	15.375	5.75	P01134
31069	S4	S4	10.75	17.25	6.5	P01134,P01137
31089	LS23	LS23	10.375	16.25	5.875	P00110
31094	L1	L1	14.32	23.125	8.805	P00829
31125	S4	S4	12.25	20.75	8.5	(2) P01137
31131	L2	L2	14.125	23.375	9.25	Ninguno
31162	L1	S4	11.875	19.375	7.5	P01137
31176	S4	S4	7.125	10.625	3.5	(2) P01135
31197	LS27	LS23	14.79	22.3	7.51	Ninguno
31538	S4	LS23	14.125	16.75	2.625	P00124,P01137
31542	LS23	LS30	10.375	16.25	5.875	Ninguno
32022	S4	LS12	9.875	15.75	5.875	P01134
32066	S4	XP7	9.25	14.5	5.25	P01134
32067	S4	LS19	8.68	13.37	4.69	P01134
32073	LS28	L2	13.625	22.5	8.875	Ninguno
32075	S4	LS25	10.62	16.48	5.86	P01135
32080	S4	LS26	12.375	19.75	7.375	P01134
32113	S4	LS23	8.875	13.75	4.875	P01134
32118	S4	LS20	8.375	11	2.625	P01135
32127	S4	XP7	8.625	13.25	4.625	P01135
32132	S4	SPEC	8.68	13.37	4.69	P01134
32134	S4	LS18	8.125	12.125	4	P01134
32143	S4	LS14	11.625	19.25	7.625	P01134,P00436
32186	XP7	LS92	14.5	24	9.5	Ninguno
32191	S4	LS17	10.25	16.5	6.25	P01135
32194	LS39	LS39	11.5	16.5	5	Ninguno
32196	S4	XP7	12.5	19.875	7.375	P01136
32197	XP7	L1	12.375	20.375	8	Ninguno
32202	S4	LS26	12.125	19.75	7.625	P01136
32206	S4	LS23	8.375	12.5	4.125	P01137
32212	LS74	LS74	13.875	22.875	9	Ninguno
32214	S4	XP7	8.625	13	4.375	P01135
32215	XP7	LS28	13.75	22.75	9	Ninguno
32217	S4	LS23	9.25	14.375	5.125	P01134
32224	S4	XP7	9.5	14	4.5	P1134
32225	XP7	LS92	16.34	26.75	10.41	Ninguno
32227	S4	LS26	9.625	14.75	5.125	P01135
32231	L1	LS26	13.375	22.875	9.5	Ninguno
32233	LS28	LS28	11.75	18	6.25	Ninguno
32235	S4	L1	9.25	14	4.75	P01135



# TABLA DE MEDIDAS

\*Longitudes en pulgadas

Número de Parte	Códigos de Montura		Longitudes			Accesorios
	Sup.	Inf.	Comprimida	Extendida	Viaje	
<b>AMORTIGUADORES</b>						
32237	L1	LS26	13.875	22.875	9	P00827
32238	L1	LS26	15.34	26.41	11.07	P00827
32239	L1	LS26	14.97	24.63	9.66	Ninguno
32243	S4	LS26	9.25	14	4.75	P01135
32245	S4	LS50	8.75	13.5	4.75	P01134
32250	S4	LS38	9.625	14.875	5.25	P01135
32251	XP7	LS28	15.5	25.875	10.375	Ninguno
32252	S4	XP7	13	21.125	8.125	P01136
32253	XP7	LS26	15	25.25	10.25	P00941
32254	LS77	LS28	11	16.375	5.375	Ninguno
32258	S4	XP7	8.625	13.375	4.75	P01134
32259	S4	L1	9.375	14.25	4.875	P01135
32260	S4	LS26	12.25	20.625	8.375	P01135
32263	LS77	LS28	11.34	16.44	5.1	Ninguno
32264	XP7	LS92	14	22.625	8.625	P00941
32266	XP7	LS92	15.5	25.375	9.875	Ninguno
32267	S4	L1	9.875	14.625	4.75	P01135
32268	S4	LS26	13.125	21.75	8.625	P01135
32269	L1	LS25	13.375	21.5	8.125	Ninguno
32270	L1	L1	15.125	25	9.875	Ninguno
32271	S4	LS23	10.25	15.375	5.125	P01134
32272	LS78	L3	12.625	19.75	7.125	P00120
32273	S4	LS24	9.125	13.625	4.5	P01134
32274	S4	LS50	11.75	18.125	6.375	P01134
32275	LS27	LS26	10.5	15.75	5.25	Ninguno
32277	S5	LS92	9.5	13.75	4.25	P01167
32278	LS92	LS92	15.47	24.63	9.16	Ninguno
32279	S5	LS92	13.875	21.75	7.875	P01167
32280	S4	LS26	10.125	15	4.875	P1135
32284	S4	LS26	13.875	22.75	8.875	P01136
32285	S4	LS26	11.25	16.75	5.5	P01135
32286	S4	S4	13.5	22.125	8.625	(2) P01137
32290	LS28	LS28	11.25	17.125	5.875	Ninguno
32292	S4	XP7	9.375	14.5	5.125	P01134
32293	L1	L1	11.97	19.66	7.69	Ninguno
32294	L3	L3	12.875	20.375	7.5	P00575
32295	L3	L3	12.5	19.625	7.125	P00575
32296	S4	XP7	13.5	17.875	4.375	P01135,P00941
32300	S4	XP7	8.375	12.75	4.375	P01134
32302	S5	XP7	10.25	15	4.75	P01167
32303	S4	LS26	13.875	23.75	9.875	P01135
32304	S4	LS39	10.04	14.26	4.22	P1136
32306	XP7	LS24	12.5	19.625	7.125	Ninguno
32315	S4	LS22	13	21.5	8.5	P01134

Número de Parte	Códigos de Montura		Longitudes			Accesorios
	Sup.	Inf.	Comprimida	Extendida	Viaje	
<b>AMORTIGUADORES</b>						
32316	S4	LS26	11.5	18.25	6.75	P01134
32318	S4	XP7	8.5	13	4.5	P01135
32319	LS28	LS28	14.47	22.81	8.34	Ninguno
32321	LS28	LS28	15.25	24.625	9.375	Ninguno
32322	LS26	LS26	13.75	21.75	8	Ninguno
32323	LS26	LS26	14.375	23.125	8.75	Ninguno
32324	S4	LS43	14.27	23.93	9.66	P01135
32325	S4	LS43	16.125	27.375	11.25	P01136
32326	S4	XP7	10.375	14.375	4	P01135
32327	LS92	LS92	15.55	23.81	8.26	Ninguno
32328	S4	CLEV	10.97	15.07	4.1	P01136
32329	LS43	LS43	15.375	25.5	10.125	Ninguno
32330	S4	XP7	10.375	13.625	3.25	P01135
32333	LS26	LS26	12.5	20.125	7.625	Ninguno
32334	S4	L3	12.375	20	7.625	P01134,P00081
32335	LS52	LS30	14.375	23.125	8.75	Ninguno
32336	S4	LS23	9.625	15	5.375	P01134
32337	S4	LS78	11.625	18.625	7	P01134
32338	S4	XP7	13	21.125	8.125	P01136,P00941
32339	LS29	LS25	13.375	21.75	8.375	Ninguno
32340	S5	XP7	10.25	15	4.75	P01167
32341	LS92	LS92	16	26.125	10.125	Ninguno
32345	LS92	LS92	15.05	24.07	9.02	Ninguno
32346	S4	XP7	11.5	17.875	6.375	P01135,P00941
32347	S4	SPEC	10.875	15.375	4.5	P01135
32348	LS47	LS47	14.75	23.5	8.75	Ninguno
32350	S5	LS42	10.25	15.125	4.875	P01167
32356	S5	L1	10.125	15	4.875	P01167
32357	L1	LS26	16.5	28.25	11.75	Ninguno
32358	L1	LS26	14.25	22.875	8.625	Ninguno
32359	L1	LS26	18	31	13	Ninguno
32361	L1	LS24	10.375	16	5.625	P00019
32362	S4	XP7	9.625	14	4.375	P01134
32363	LS88	LS54	14.5	22.75	8.25	Ninguno
32365	LS92	LS92	15.75	26.125	10.375	Ninguno
32366	S5	LS92	14.375	22.75	8.375	P01167
32370	L1	L1	16.125	27.25	11.125	Ninguno
32372	L1	LS26	14	22.25	8.25	Ninguno
32373	LS77	LS77	11.75	15.875	4.125	Ninguno
32376	S4	XP7	10	15.5	5.5	P01135
32377	L1	L1	12.625	19.75	7.125	Ninguno
32381	S4	L1	11.5	18.375	6.875	P01135
32383	S4	XP7	9.375	14.5	5.125	P01134
32385	LS28	L2	14.75	25.375	10.625	Ninguno



# TABLA DE MEDIDAS

\*Longitudes en pulgadas

Número de Parte	Códigos de Montura		Longitudes			Accesorios
	Sup.	Inf.	Comprimida	Extendida	Viaje	
<b>AMORTIGUADORES</b>						
32386	L1	LS26	15.97	26.38	10.41	Ninguno
32388	S4	LS23	8.75	13.375	4.625	P01134
32389	L1	LS50	13.375	20.75	7.375	Ninguno
32390	S6	XP7	9.875	14.25	4.375	P01167
32391	LS47	LS47	16	26.5	10.5	Ninguno
32392	S6	LS47	10.75	15.875	5.125	P01167
32399	S1	LS31	15.875	23.625	7.75	P00906
32403	S1	LS7	16.457	25.787	9.33	Ninguno
32404	S4	LS38	15.72	24.68	8.96	P01134
32405	SPEC	LS23	11.07	16.38	5.31	Ninguno
32406	LS30	LS28	15.25	24.32	9.07	Ninguno
32407	LS30	LS39	15.19	24.88	9.69	Ninguno
32410	S1	SPEC	14.66	21.42	6.76	P00906
33033	L1	LS26	10.125	14.625	4.5	P00019
33049	S4	L1/CP1	12.625	21.25	8.625	P00576,P01134
33050	XP7	L1/CP1	14.125	23.875	9.75	P00576
33059	XP7	SP	9.5	14.25	4.75	P00423
33076	LS37	LS37	9.93	14.63	4.7	Ninguno
33084	LS24	LS24	14.125	22.875	8.75	P00019
33086	LS29	LS29	12.875	21	8.125	Ninguno
33095	LS7	LS7	13.375	21.5	8.125	Ninguno
33101	LS92	LS92	13.125	16.25	3.125	Ninguno
33108	S4	LS7	16.125	21.25	5.125	P01134
33127	S4	XP4	9.125	13.75	4.625	P01136
33128	S4	L1/CP1	12.125	19.5	7.375	P01136,P00576
33134	S4	LS92	14.5	19.125	4.625	P01136
33136	S4	L1/CP1	12.125	19.5	7.375	P01136,P00576
33137	S4	LS26	14.5	19.125	4.625	P01136
33146	LS3	LS27	11.4	17.78	6.38	Ninguno
33154	LS30	LS43	10.47	16.14	5.67	Ninguno
33157	S7	LS74	18.15	28.62	10.47	Ninguno
33158	LS30	LS78	10.9	16.85	5.95	Ninguno
33159	LS30	LS7	10.9	16.85	5.95	Ninguno
33160	M10	LS4	19.45	28.7	9.25	Ninguno
33178	S4	LS21	10	14.5	4.5	P01134
33179	XP5	LS92	14.31	22.96	8.65	Ninguno
33180	S4	LS23	8	11.91	3.88	P01137
33181	L1	L1	14	22.5	8.5	Ninguno
33182	S4	LS23	8.25	11.69	3.44	P01137
33183	LS30	LS92	10.49	16.04	5.55	Ninguno
33184	LS40	LS77	14.45	23.1	8.65	Ninguno
33185	S4	LS27	18.3	22.05	3.75	P01744
33187	S4	LS82	15.21	25.1	9.89	P01137
33188	LS84	LS26	11.55	18.44	6.89	Ninguno

Número de Parte	Códigos de Montura		Longitudes			Accesorios
	Sup.	Inf.	Comprimida	Extendida	Viaje	
<b>AMORTIGUADORES</b>						
33189	S4	LS92	11.45	17.77	6.32	P01417
33190	LS28	LS28	10.4	14.91	4.51	Ninguno
33191	LS30	LS28	13.82	21.84	8.02	Ninguno
33192	LS38	LS38	11.26	16.78	5.52	Ninguno
33193	SPEC	LS44	10.28	15.96	5.68	Ninguno
33194	XP16	LS38	14.01	22.53	8.52	Ninguno
33195	LS30	LS92	11.37	17.67	6.3	Ninguno
33196	S15	SPEC	16.54	20.95	4.41	P01488
33197	S4	LS34	12.45	20.15	7.7	P01136
33198	S4	LS32	12.46	20.03	7.57	P01136
33200	S41	LS51	15.18	25.12	9.94	P01136
33202	S4	LS31	15.5	26.07	10.57	P01136
33203	S4	LS16	17.78	21.56	3.78	P01136
33204	S21	LS29	13.5	16.65	3.14	P00839
33205	SPEC	LS29	12.42	17.33	4.91	Ninguno
33206	S41	LS51	15.69	26.43	10.74	P01136
33207	LS107	LS108	10.49	16.04	5.55	Ninguno
33208	S41	LS23	13.5	22.46	8.96	P01134
33209	S4	LS32	14.95	23.79	8.84	P01603
33210	S8	LS37	19.01	28.13	9.11	P01699
33212	S53	LS68	14.83	24.1	9.27	P01167
33213	S41	LS23	13.02	21.48	8.46	P01134
33215	LS74	LS52	15.11	24.05	8.94	Ninguno
33216	S14	CLEV	20.32	27.52	7.19	P01505, P01524
33217	S5	LS40	11.98	15.44	3.46	P01614
33218	LS108	LS109	15.04	24.18	9.14	Ninguno
33219	S5	LS84	18	23.87	5.87	P01733
33221	S41	LS30	21.16	25.06	3.91	P01722
33222	L1	LS47	12.54	20.21	7.67	Ninguno
33223	LS44	LS44	11.79	17.69	5.9	Ninguno
33224	S1	SPEC	14.67	21.32	6.46	P00906
33225	LS108	LS109	14.42	22.94	8.52	Ninguno
33226	S4	LS31	17.72	21.81	4.09	P01136
33274	LS27	LS27	11.47	17.41	5.94	Ninguno
33275	S4	L1	13.03	21.85	8.82	P01137
34501	S4	CLEV	10.875	15.25	4.375	P01135
34504	S5	LS42	10.375	15.125	4.75	P01167
34514	S5	XP10	9.875	14.25	4.375	P01167
34515	LS47	LS47	16	26.5	10.5	Ninguno
34516	S5	LS47	10.75	15.875	5.125	P01167
34517	XP7	LS26	15.25	25.125	9.875	Ninguno
34518	L1	LS26	13.75	21.875	8.125	Ninguno
34519	XP7	LS26	16.75	28.25	11.5	Ninguno
34520	S5	XP12	11	16.375	5.375	P01167



# TABLA DE MEDIDAS

\*Longitudes en pulgadas

Número de Parte	Códigos de Montura		Longitudes			Accesorios
	Sup.	Inf.	Comprimida	Extendida	Viaje	
<b>AMORTIGUADORES</b>						
34521	LS47	LS47	16.5	27.5	11	Ninguno
34522	S5	LS47	14.5	22.75	8.25	P01167
34523	S5	LS47	13.625	20.75	7.125	P01167
34524	LS49	LS26	14.75	24.75	10	Ninguno
34525	S5	LS92	13.625	20.75	7.125	P01167
34526	L1	LS38	17.5625	29.625	12.062	Ninguno
34529	LS80	LS92	15.24	22.62	7.38	Ninguno
34530	S4	XP4	9.75	14.02	4.27	P01136
34531	XP5	LS43	13.69	21.57	7.88	Ninguno
34532	XP4	LS39	15.19	24.32	9.13	Ninguno
34534	S5	LS92	14.75	21.38	6.63	P01167
34535	LS92	LS92	17.18	27.69	10.51	Ninguno
34655	S5	XP5	10.25	14.875	4.625	P01167
34656	S4	LS26	14.375	24.25	9.875	P01135
34657	S4	LS39	10	14.25	4.25	P01136
34658	S4	LS26	16	27.5	11.5	P01136
34672	LS26	LS26	14.25	23	8.75	Ninguno
34673	S4	LS43	14.25	23.875	9.625	P01135
34674	S4	LS43	16.125	27.375	11.25	P01136
34675	S4	XP5	10.375	14.375	4	P01135
34676	LS47	LS47	15.5	23.75	8.25	Ninguno
34677	S4	CLEV	11	15.125	4.125	P01136
34678	LS47	LS47	16.75	25.5	8.75	Ninguno
34684	S5	L1	10.125	15	4.875	P01167
34685	L1	LS26	16.5	28.25	11.75	Ninguno
34686	L1	LS26	14.25	22.875	8.625	Ninguno
34687	L1	LS26	18	31	13	Ninguno
34689	S5	XP5	10.25	15	4.75	P01167
34690	LS47	LS47	16	26	10	Ninguno
34692	LS47	LS47	14.75	23.5	8.75	Ninguno
34694	LS47	LS47	15	24.125	9.125	Ninguno
34729	S4	LS26	10	14.625	4.625	P01135
34730	S4	LS26	10.5	15.875	5.375	P01135
34731	L1	LS26	12.75	20.5	7.75	Ninguno
34732	LS26	LS26	14	22.5	8.5	Ninguno
34733	LS26	L1	16.375	27.25	10.875	Ninguno
34736	L1/CP1	LS36	10.375	16	5.625	P00019
34740	S4	XP5	11.5	16.5	5	Ninguno
34741	S4	XP5	9.625	14	4.375	P01134
34750	S4	XP8	8.875	13.375	4.5	P01135
34754	LS23	L1	8.84	12.5	3.66	Ninguno
34755	LS48	LS54	14.5	22.75	8.25	Ninguno
34756	XP5	LS47	14	22.75	8.75	Ninguno
34759	S4	LS26	12.5	19.875	7.375	P01135

Número de Parte	Códigos de Montura		Longitudes			Accesorios
	Sup.	Inf.	Comprimida	Extendida	Viaje	
<b>AMORTIGUADORES</b>						
34760	S4	L1	9.875	14.625	4.75	P01135
34761	S4	LS26	13.125	21.75	8.625	P01135
34762	XP7	LS47	13.875	22.5	8.625	Ninguno
34763	XP7	LS47	14.625	23.875	9.25	Ninguno
34766	S4	XP11	13.12	20.25	7.13	P00941,P01136
34767	XP7	LS47	15.25	25.25	10	Ninguno
34769	LS25	LS74	13.8	21.81	8.01	Ninguno
34770	L1	LS26	16.19	27.01	10.82	Ninguno
34771	LS39	L2	16.625	28.5	11.875	Ninguno
34776	S5	LS47	9.5	13.75	4.25	P01167
34777	LS47	LS47	15.375	24.625	9.25	Ninguno
34778	S5	LS47	13.875	21.75	7.875	P01167
34781	LS47	LS47	15.75	26.125	10.375	Ninguno
34782	S5	LS47	14.375	22.75	8.375	P01167
34785	S4	XP14	8.72	12.8	4.08	P01137
34786	LS28	LS28	14.59	22.69	8.1	Ninguno
34787	S5	S5	14.25	23.25	9	(2) P01167
34788	S4	L3	14.375	23.25	8.875	P00120,P01167
34789	LS39	LS39	15.34	24.57	9.23	Ninguno
34790	S4	LS26	9.72	14.8	5.08	P01135
34791	L1	L1	16.125	27.25	11.125	Ninguno
34793	S4	LS26	10.125	15	4.875	P01135
34794	S4	XP8	9.25	13.625	4.375	P01135
34795	LS47	LS47	16.42	25.53	9.11	Ninguno
34796	S4	L1	9.375	14.25	4.875	P01135
34797	L1	LS26	14	22.25	8.25	Ninguno
34798	LS77	LS39	11.375	16.5	5.125	Ninguno
34799	LS77	LS39	11.75	15.875	4.125	Ninguno
34800	S5	XP10	9.63	13.77	4.14	P01167
34802	L1	L1	14	22.75	8.75	P00829
34803	L1	L1	13.25	21	7.75	P00573
34804	S4	XP5	13.59	18.11	4.52	P01135,P00941
34810	S2	CLEV	13.72	17.97	4.25	P01299
34811	LS47	LS47	16.21	25.32	9.11	Ninguno
34812	LS92	LS92	15.34	22.35	7.01	Ninguno
34813	S6	LS40	14.51	24.07	9.56	P01167
34814	S5	LS47	14.75	21.38	6.63	Ninguno
34815	LS52	LS47	15.18	24.43	9.25	Ninguno
34816	LS52	LS47	14.46	22.96	8.5	Ninguno
34817	L1/CP1	LS36	9.875	14.625	4.75	P00019
34821	L1	LS38	14.25	22.875	8.625	Ninguno
34822	LS37	LS37	13.875	22.75	8.875	Ninguno
34824	L1/CP1	LS47	14	22.875	8.875	P00019
34831	S4	XP8	8.875	13.375	4.5	P01135



# TABLA DE MEDIDAS

\*Longitudes en pulgadas

Número de Parte	Códigos de Montura		Longitudes			Accesorios
	Sup.	Inf.	Comprimida	Extendida	Viaje	
<b>AMORTIGUADORES</b>						
34832	LS39	L2	14.75	24.375	9.625	Ninguno
34839	LS24	LS24	9.93	14.63	4.7	Ninguno
34853	L2	L2	13.25	21.125	7.875	Ninguno
34854	LS39	L2	15.625	26.25	10.625	Ninguno
34868	S4	XP8	10	15.5	5.5	P01135
34899	S4	LS38	9.875	14.375	4.5	P01135
34900	S4	LS38	10.625	15.875	5.25	P01135
34901	S4	LS38	13.75	22.625	8.875	P01135
34904	L1	L1	11.875	18.125	6.25	P00411
34905	L1	L1	12.625	19.75	7.125	Ninguno
34906	S4	LS38	10.125	16.75	6.625	P01135
34907	S4	LS38	13.375	21.25	7.875	P01135
34909	S4	S4	13.25	22	8.75	(2) P01134
34910	LS39	LS39	13	20.875	7.875	Ninguno
34911	S4	LS38	12.375	19.75	7.375	P01136
34912	L1/CP1	LS54	14.125	23	8.875	P00019
34919	LS37	LS39	11.625	18.25	6.625	P00816
34920	LS47	LS47	15.5	26.125	10.625	Ninguno
34926	S4	L1	11.5	18.375	6.875	P01135
34927	L1	LS26	13.5	21.75	8.25	Ninguno
34928	S4	LS26	11.625	18.5	6.875	P01135,P00864
34930	L1	LS26	14.875	24.75	9.875	Ninguno
34934	SPEC	LS47	14.4375	24	9.562	Ninguno
34944	LS37	LS37	11.75	18.375	6.625	P00816
34945	S4	XP5	8.9375	13.375	4.437	P1134
34953	S4	XP5	9.375	14.5	5.125	P01134
34954	S4	L1	11.5	19.125	7.625	P01137
34958	L1	LS38	12.625	20.375	7.75	P00826
34960	LS47	LS47	14.125	22.875	8.75	Ninguno
34963	L1	LS26	14.125	22.875	8.75	Ninguno
34964	L1	LS26	15.75	26.375	10.625	Ninguno
34968	S4	LS23	8.38	12.57	4.19	P1137
34983	S4	XP5	9.5	13.75	4.25	P01134
34985	XP7	LS47	16.125	26.75	10.625	Ninguno
37011	S4	LS26	9.875	14.5	4.625	P01135
37013	L1	LS26	14.375	23	8.625	P00827
37014	L1	LS26	16	26.375	10.375	P00827
37015	S4	L1	9.75	14.5	4.75	P01135
37016	S4	LS27	9	13	4	P01135
37017	L3	LS27	14.625	23.5	8.875	P00867
37019	S4	XP4	8.875	13.25	4.375	P01134
37021	XP7	LS47	14.5	24	9.5	Ninguno
37022	S4	LS23	9.625	14.375	4.75	P01134
37024	S4	L1	13.375	21.875	8.5	P01134

Número de Parte	Códigos de Montura		Longitudes			Accesorios
	Sup.	Inf.	Comprimida	Extendida	Viaje	
<b>AMORTIGUADORES</b>						
37026	S4	XP4	12.875	20.375	7.5	P01136
37027	XP12	L1	12.75	20	7.25	Ninguno
37029	L1	L1	14.375	23	8.625	Ninguno
37030	S4	LS82	9.25	13.625	4.375	P01134
37031	S4	LS23	10.5	16.375	5.875	P01134
37032	L3	L3	13.875	21.5	7.625	P00575
37033	S4	L3	13.25	20.875	7.625	P00081,P01134
37036	S4	L1	11.625	18.375	6.75	P01135
37037	L1	LS26	13.5	21.75	8.25	Ninguno
37040	LS37	LS37	11.875	18.375	6.5	P00816
37041	L1/CP5	LS47	14.125	22.875	8.75	P00019
37045	L2	L2	13.125	20.25	7.125	Ninguno
37046	LS39	L2	15.75	26.125	10.375	Ninguno
37047	S4	LS23	8.125	12.125	4	P01137
37049	L1/CP5	LS36	10	14.625	4.625	P00019
37052	L1	LS26	14.375	23	8.625	Ninguno
37053	S4	LS38	10.75	15.875	5.125	P01135
37058	S4	XP4	8.5	12.375	3.875	P01134
37060	S4	XP5	10.25	15.125	4.875	P01135
37061	LS28	LS26	12	18.125	6.125	Ninguno
37062	LS77	LS39	11.25	16.5	5.25	Ninguno
37063	S4	XP5	9.25	14	4.75	P01134
37064	LS74	LS74	14.75	23.125	8.375	Ninguno
37065	LS28	LS28	12	18.125	6.125	Ninguno
37066	S4	XP2	8.625	13	4.375	P01135
37067	XP8	LS39	14.625	23.5	8.875	Ninguno
37068	S4	LS37	9.75	15	5.25	P01135
37069	XP8	LS39	15.625	26.25	10.625	Ninguno
37070	S4	LS26	12.125	18.25	6.125	P01134
37072	S4	XP5	9.375	14.5	5.125	P01134
37073	L1	L1	13	20.75	7.75	Ninguno
37074	L1	S4	12.125	19.25	7.125	P01137
37077	S4	LS23	8.875	13.75	4.875	P01134
37078	L1	L1	12.625	20	7.375	Ninguno
37081	S4	XP4	13	20.75	7.75	P01136
37082	L1	LS25	13.625	21.5	7.875	Ninguno
37083	S4	XP4	13.25	21.125	7.875	P01136
37086	XP7	LS47	14.625	23.75	9.125	Ninguno
37087	XP7	LS47	15.375	25.25	9.875	Ninguno
37091	LS39	LS39	13.125	20.875	7.75	Ninguno
37094	LS39	L2	14.875	24.375	9.5	Ninguno
37096	S4	XP8	8.875	13.375	4.5	P01135
37098	L1	L1	11.75	18.25	6.5	Ninguno
37099	LS39	LS39	11.625	16.5	4.875	Ninguno



# TABLA DE MEDIDAS

\*Longitudes en pulgadas

Número de Parte	Códigos de Montura		Longitudes			Accesorios
	Sup.	Inf.	Comprimida	Extendida	Viaje	
<b>AMORTIGUADORES</b>						
37100	S4	LS23	9.625	14.75	5.125	P01134
37101	L1	L1	15.125	24.875	9.75	Ninguno
37108	S4	LS23	10.375	15.25	4.875	P01134
37109	LS78	L3	12.875	19.625	6.75	P00120
37110	LS27	LS26	10.625	15.75	5.125	Ninguno
37111	S4	XP5	9.375	14.5	5.125	P01134
37112	L1	L1	12.375	19	6.625	Ninguno
37113	L3	L3	13.25	20.375	7.125	P00575
37114	L3	L3	12.875	19.5	6.625	P00575
37116	S4	L1	10.25	14.875	4.625	P01135
37117	S4	LS26	13.5	22	8.5	P01135
37120	S4	LS38	14.5	24.375	9.875	P01135
37121	L1	LS38	11.875	18.375	6.5	Ninguno
37122	S4	XP4	13.625	18	4.375	P01135,P00941
37123	LS28	LS28	11.375	17	5.625	Ninguno
37129	S4	XP4	8.375	12.25	3.875	P01134
37130	LS77	LS39	11.75	16	4.25	Ninguno
37131	S5	XP5	10.25	14.875	4.625	P01167
37135	XP12	LS37	12.5	19.625	7.125	Ninguno
37137	S4	XP5	8.5	13	4.5	P01137
37138	LS28	LS28	14.625	22.75	8.125	Ninguno
37144	LS26	LS26	13.75	21.75	8	Ninguno
37147	S4	LS43	14.25	23.875	9.625	P01135
37148	S4	LS43	16.125	27.375	11.25	P01136
37153	S4	XP5	10.5	13.5	3	P01135
37154	LS26	LS26	14.125	20.125	6	Ninguno
37156	LS26	LS26	12.75	20.25	7.5	Ninguno
37157	S4	L3	12.5	20	7.5	P00081,P01134
37158	LS52	LS30	14.5	23.25	8.75	Ninguno
37159	S4	LS23	10.125	15	4.875	P01134
37160	S4	LS78	11.875	18.5	6.625	P01134
37161	S4	XP4	13	20.75	7.75	P00941,P01136
37162	LS29	LS25	13.75	21.75	8	Ninguno
37163	S5	XP5	10.25	15	4.75	P01167
37164	LS47	LS47	16	26	10	Ninguno
37171	S4	LS35	8.03	11.91	3.88	P01137
37172	LS49	LS49	13.94	22.63	8.69	Ninguno
37177	S4	XP4	11.625	18	6.375	P01135,P00941
37181	S5	LS42	10.25	15.125	4.875	P01167
37183	S6	LS43	11.51	17.27	5.76	P01482
37184	S5	LS68	14.37	23.14	8.77	P01167
37186	S4	S4	14	24.25	10.25	(2) P01137
37187	LS37	L1/CP5	9.375	14.25	4.875	P00019
37188	L1/CP3	L1/CP3	14	23.625	9.625	P00572, (2) P00576

Número de Parte	Códigos de Montura		Longitudes			Accesorios
	Sup.	Inf.	Comprimida	Extendida	Viaje	
<b>AMORTIGUADORES</b>						
37189	L2	L2	15.25	25.625	10.375	Ninguno
37195	SPEC	SPEC	8.375	11.375	3	Ninguno
37196	SPEC	SPEC	8.875	12.375	3.5	BE17110286
37199	S4	L1	14.375	24.25	9.875	P01137
37202	LS26	LS26	14.875	21.25	6.375	Ninguno
37203	LS52	LS28	14	21.875	7.875	Ninguno
37204	LS74	LS52	15.125	24.25	9.125	Ninguno
37206	S5	XP12	9.875	14.25	4.375	P01167
37217	S4	LS51	15.25	25.125	9.875	P01137
37218	LS38	LS38	11.375	17.375	6	Ninguno
37219	S4	LS43	13.52	15.02	1.5	P01136,P01520
37220	S4	LS26	9.75	14.75	5	P01135
37225	S4	LS36	8.78	13.39	4.61	P01134
37226	LS49	LS50	13.43	20.69	7.26	Ninguno
37231	S4	LS22	13	21.25	8.25	P01134
37234	LS29	LS29	13.75	22.375	8.625	Ninguno
37237	S4	LS51	17.375	23.5	6.125	P01136
37238	S4	LS23	13.625	22.5	8.875	P01134
37239	S4	LS23	13.125	21.5	8.375	P01134
37240	S5	LS54	14.875	24	9.125	P01167
37241	LS28	LS29	14.56	23.07	8.51	Ninguno
37242	LS28	LS29	14.625	22.25	7.625	Ninguno
37243	S4	L1	13	21.5	8.5	P01137
37244	LS51	LS56	10.875	15.75	4.875	P01380
37245	S4	LS35	8.25	11.69	3.44	P01137
37246	LS39	LS39	11.5	16.875	5.375	Ninguno
37250	S4	LS44	14	23.2	9.2	P01134
37251	LS40	LS44	15.18	24.19	9.01	Ninguno
37252	LS40	LS44	14.55	22.94	8.39	Ninguno
37253	LS44	LS44	11.93	17.69	5.76	Ninguno
37269	S4	LS26	12.375	19.75	7.375	P01134
37270	S5	LS68	14.06	22.2	8.14	P01167
37272	S4	LS82	12.55	19.57	7.02	P01134
37273	L1	LS43	13.43	21.08	7.65	Ninguno
37274	LS44	LS44	10.3	14.7	4.4	Ninguno
37275	L1	LS43	12.43	19.5	7.07	Ninguno
37276	L1	LS43	12.8	20.25	7.45	Ninguno
37279	S4	LS35	12.76	20.4	7.64	P01134
37280	S4	LS35	13.76	22.4	8.64	P01134
37281	LS43	LS43	12.3	18.7	6.4	Ninguno
37282	S5	LS40	11.98	15.44	3.46	P01614
37283	S5	LS29	10.1	15.1	5	P01614
37284	S5	SPEC	16.05	26.51	10.46	P01167
37285	S1	LS26	13.74	21.85	8.11	P01136



# TABLA DE MEDIDAS

\*Longitudes en pulgadas

Número de Parte	Códigos de Montura		Longitudes			Accesorios
	Sup.	Inf.	Comprimida	Extendida	Viaje	
<b>AMORTIGUADORES</b>						
37286	SPEC	LS26	13.74	21.85	8.11	Ninguno
37287	XP6	LS38	14.55	23	8.45	Ninguno
37289	LS29	LS29	11.34	17.03	5.69	Ninguno
37290	LS30	LS30	10.49	15.57	5.08	Ninguno
37298	S5	LS38	15	24.38	9.38	P01167
37301	S5	SPEC	17.1	27.56	10.46	P01167
37302	S4	SPEC	15.53	26.72	11.19	P01136
37307	SPEC	LS51	12.4375	18.6875	6.25	Ninguno
37308	LS38	LS38	13.6875	20.9375	7.25	Ninguno
37309	LS38	LS19	13.95	21.43	7.48	Ninguno
37310	S1	LS32	12.01	16.66	4.65	P00906
37311	LS38	LS38	12.74	20.13	7.39	Ninguno
37312	S2	LS96	13.58	16.15	2.57	P00839
37315	LS19	LS44	11.01	16.03	5.02	Ninguno
37316	XP16	LS38	14.18	22.57	8.39	Ninguno
37317	S2	LS29	13.44	16.59	3.14	P00839
37318	S4	LS51	15.3	25.07	9.77	P01136
37319	LS44	LS25	12.31	18.53	6.22	Ninguno
37320	L1	L1	12.34	19.68	7.34	Ninguno
37321			9.35	14.79		P01137
37322	LS53	LS50	11.5	17.11	5.61	Ninguno
37323	LS92	S5	12.25	19.52	7.27	P01614
37324	LS46	LS54	12.3	18.68	6.38	Ninguno
37326	S4	LS31	17.72	21.81	4.09	P01136
37327	S4	LS82	15.72	26.48	10.76	P01136
37328	LS84	LS29	12.87	19.59	6.72	Ninguno
37329	S5	CLEV	16.97	23.13	6.16	P01637,P00590
37331	S4	LS31	15.38	25.72	10.34	P01136
37334	LS28	LS27	11.64	17.53	5.88	Ninguno
37336	S6	LS29	19.96	22.46	2.5	P01136
37338	S1	LS25	17.08	20.93	3.85	P01620
37339	XP15	LS20	13.33	21.52	8.19	Ninguno
37341	S1	SPEC	14.93	23.11	8.18	P00906
37342	S6	LS54	14.18	22.71	8.53	P01482
37343	S1	CLEV	14.77	22.46	7.7	P00906
37345	LS99	LS99	11.77	18.03	6.26	Ninguno
37346	LS97	S2	15.92	22.12	6.2	BE17110669
37347	LS97	S2	15.92	22.12	6.2	BE17110669
37348	S1	LS46	10	14.45	4.45	BE17110126
37349	LS27	LS27	13.34	20.94	7.8	Ninguno
37350	S1	LS43	13.66	20.19	6.59	P01743
37351	LS92	LS92	14.97	22.56	7.59	Ninguno
37352	S4	LS29	20.34	23.83	3.48	P01136
37355	LS27		14.33	22.9	8.57	Ninguno

Número de Parte	Códigos de Montura		Longitudes			Accesorios
	Sup.	Inf.	Comprimida	Extendida	Viaje	
<b>AMORTIGUADORES</b>						
37356	S7		19.17	28.78	9.61	Ninguno
37357	S2	LS29	12.09	15.14	3.04	P00839
37358	S15	LS43	19	25.93	6.93	P01505
37359	LS40	LS40	14.06	22.09	8.03	Ninguno
37360			18.62	28.46		Ninguno
37361	LS78	LS31	12.61	18.87	6.26	Ninguno
37362	LS96	LS40	14.42	22.69	8.27	Ninguno
37363	S2	LS96	12.22	17.4	5.18	P00839
37365	S2	LS91	16.62	19.69	3.07	P00839
37366	LS30	LS43	10.90	16.85		Ninguno
37367			12.35	19.64		Ninguno
37368			8.93	13.97		P01431
37369			12.08	19.84		Ninguno
37370			12.87	20.03		Ninguno
37371			16.75	27.07		Ninguno
37372	S4		9.59	14.37	4.78	P01780
37373	L1		13.51	21.83	8.32	P00120
37375			14.60	22.83		Ninguno
37376	S2	LS91	15.01	19.58	4.57	P00839
37377	LS55	LS50	12.86	19.03	6.17	Ninguno
37378	S1	XP7	14.84	22.08	7.24	P01431
37379	LS104	LS50	11.74	17.02	5.29	Ninguno
37380	LS97	LS38	16	21.94	5.94	Ninguno
37381	LS97	LS38	17.26	24.41	7.15	Ninguno
37382	S1	LS43	16.85	25.2	8.35	P00906
37386	S1	LS48	15.56	23.28	7.72	P00906
37387	XP16	LS39	14.07	20.85	6.52	Ninguno
37388	LS26	LS26	15.88	24.65	8.77	Ninguno
37389	S1	XP7	13.18	20.18	7	P01141
37390	S1	LS46	13.98	22.98	9	P01431
37392	S8	LS28	18.3	28.04	9.74	P01699
37394	S13	LS43	18.48	25.78	7.3	P01505
39001	S1	LS6	15.125	20	4.875	BE17110326
39002	S1	SPEC	13.625	18.375	4.75	P00341NC
39006	S1	XP11	11.25	17.5	6.25	P00341NC
39013	S1	LS6	17.125	20.875	3.75	BE17110322
39020	S1	LS6	18.937	21.496	2.559	BE17110326
39021	S1	LS6	18.543	19.764	1.221	BE17110326
39028	S1	SPEC	9.875	14	4.125	BE17110453
39040	S2	LS34	11.125	17	5.875	BE17110559
39044	S1	LS6	17.75	18.875	1.125	BE17110322
39045	S1	LS6	16.5	18.25	1.75	BE17110322
39047	S1	LS6	18.875	22.5	3.625	BE17110326
39051	S2	SPEC	14.75	18.625	3.875	BE17110669





# TABLA DE MEDIDAS

\*Longitudes en pulgadas

Número de Parte	Códigos de Montura		Longitudes			Accesorios
	Sup.	Inf.	Comprimida	Extendida	Viaje	
<b>AMORTIGUADORES</b>						
39052	LS41	LS42	11.02	15.55	4.53	Ninguno
39102	S1	LS10	15	24	9	BE17110495
39107	S1	LS38	17.13	25.51	8.38	BE17110410
39108	S15	LS8	19.02	23.19	4.17	BE17110326
39109	S15	LS8	18.5	20.71	2.21	BE17110326
39110	S1	SPEC	18.98	24.06	5.08	BE17110814
39111	S7	LS25	16.65	24.98	8.33	P01682
39114	S1	CLEV	15.31	21.86	6.55	P01718,P00590
39129	S7	LS25	20.23	28.27	8.04	P01682
39130	S1	LS30	16.06	23.23	7.17	P00522
39131	S2	LS43	17.34	20.79	3.45	Ninguno
39132	S2	LS43	17.34	20.79	3.45	Ninguno
39136	S1	XP15	17.21	22.6	5.39	P01716
40034	LS43	LS43	15.25	22.75	7.5	Ninguno
40038	S1	SPEC	11	15.375	4.375	Ninguno
40039	LS43	LS43	15.625	23.875	8.25	Ninguno
40044	S1	SPEC	11	15.375	4.375	Ninguno
40050	LS74	LS74	15.38	22.75	7.37	Ninguno
40051	LS74	LS74	15.38	22.75	7.37	Ninguno
40052	LS74	LS74	15.38	22.75	7.37	Ninguno
40056	S1	CLEV	15	21.88	6.88	P01431
40201	LS77	LS77	11.625	17.875	6.25	Ninguno
40209	LS43	LS43	14.875	22.875	8	Ninguno
40210	LS43	LS43	14.875	22.875	8	Ninguno
40212	S1	LS72	17.708	24.477	6.769	Ninguno
66208	LS14	LS14	7.34	9.52	2.18	Ninguno
250000	LS38	LS38	11.22	17.57	6.35	Ninguno
250001	L1	L1	12.0000	19.5000	7.5000	P00411
250003	LS23	LS23	11.220	17.512	6.291	Ninguno
250004	XP7	LS26	15	25.25	10.25	P00941
250005	S4	L1	9.25	14	4.75	P01135
250006	S4	XP7	13.5	17.875	4.375	P01135,P00941
250007	L1	LS26	13.875	22.875	9	P00827
250008	S4	XP7	11.5	17.875	6.375	P01135,P00941
250009	SPEC	LS29	12.82	18	5.18	Ninguno
250010	S7	LS24	18.665	27.913	9.248	Ninguno
250011	S1	LS42	14.724	22.992	8.268	BE17110722
250012	LS40	LS40	13.625	21.75	8.125	Ninguno
250013	LS52	LS28	14	21.875	7.875	Ninguno
250014			14.32	23.12	8.805	P00829
250015	LS30	LS92	11.37	17.67	6.3	Ninguno
250016	S4	LS23	8.375	12.5	4.125	P01137
250017	S5	LS92	9.5	13.75	4.25	P01167
250018	LS92	LS92	15.47	24.63	9.16	Ninguno

Número de Parte	Códigos de Montura		Longitudes			Accesorios
	Sup.	Inf.	Comprimida	Extendida	Viaje	
<b>AMORTIGUADORES</b>						
250019	LS29	LS29	11.34	17.03	5.69	Ninguno
250020	LS19	LS44	11.01	16.03	5.02	Ninguno
250021	S4	LS32	14.95	23.79	8.84	P01603
250089	LS23	LS23	10.375	16.25	5.875	P110
250132	S4	SPEC	8.68	13.37	4.69	P1134
250147	S4	LS15	10.97	17.59	6.62	Ninguno
250157	S7	LS74	18.15	28.62	10.47	Ninguno
250158	LS30	LS78	10.9	16.85	5.95	Ninguno
250186	XP7	LS92	14.5	24	9.5	Ninguno
250194	LS39	LS39	11.5	16.5	5	Ninguno
250197	LS27	LS23	14.79	22.3	7.51	Ninguno
250224	S4	XP7	9.5	14	4.5	P1134
250290	LS28	LS28	11.25	17.125	5.875	Ninguno
250300	S4	XP7	8.375	12.75	4.375	P1134
250302	S5	XP7	10.25	15	4.75	P1167
250303	S4	LS26	13.875	23.75	9.875	P1135
250322	LS26	LS26	13.75	21.75	8	Ninguno
250410	S1	SPEC	14.66	21.42	6.76	P906
250538	S4	LS23	13.35	16.87	3.52	P1137-P124
250791	M10	L7	16.53	24.85	8.32	BE17110497
250794	S4	SPEC	14.38	24.2	9.82	P1136
250984	S1	LS7	16.5	25.75	9.25	Ninguno
251022	LS25	LS25	10.31	15.1	4.79	Ninguno
550010	S4	XP4	9.375	13.75	4.375	P01136
550011	S4	L1	12.375	20	7.625	P01136,P00576
550018	S4	LS26	12.5	20	7.5	P01136,P01344
550055	S4	LS26	12.375	20.125	7.75	P01136,P01344
550060	LS47	LS47	16.39	25.54	9.16	Ninguno
550062	LS27	LS27	17.76	29.44	11.96	Ninguno
550063	LS27	LS27	16.54	27.19	10.65	Ninguno
550064	S5	LS27	15.1	24.39	9.29	P01167
552001	LS47	LS47	15.82	24.74	8.92	Ninguno
553001	S5	LS53	13.875	17	3.125	P01611
553002	S1	SPEC	14.625	21.875	7.25	Ninguno
555031	S5	L1	10	14.875	4.875	P01167
555032	S5	LS26	13.25	22	8.75	P01167
911039	L1	LS26	15.75	26.375	10.625	Ninguno
911043	LS77	LS39	11.25	16.5	5.25	Ninguno
911044	XP7	LS47	16.25	26.75	10.5	Ninguno
911050	S4	XP5	9.5	13.75	4.25	P01134
911055	LS26	LS26	14	22.5	8.5	Ninguno
911085	XP7	LS47	14	22.375	8.375	Ninguno
911086	XP7	LS47	14.75	23.75	9	Ninguno
911096	S4	XP8	9	13.75	4.75	P01135



# TABLA DE MEDIDAS

\*Longitudes en pulgadas

Número de Parte	Códigos de Montura		Longitudes			Accesorios
	Sup.	Inf.	Comprimida	Extendida	Viaje	
<b>AMORTIGUADORES</b>						
911128	S4	L1	9.75	14.25	4.5	P01135,P01319
911131	S5	XP5	10.25	14.875	4.625	P01167
911132	S4	LS26	14.25	23.875	9.625	P01135
911133	S4	LS39	10	14.375	4.375	P01136
911134	S4	LS26	16.125	27.5	11.375	P01136
911140	LS28	LS28	15.25	24.625	9.375	Ninguno
911149	S4	XP5	10.375	14.375	4	P01135
911150	LS47	LS47	15.5	23.875	8.375	Ninguno
911151	S4	SPEC	10.875	15.125	4.25	P01136
911152	LS47	LS47	16.75	25.5	8.75	Ninguno
911164	LS47	LS47	16	26.125	10.125	Ninguno
911166	LS47	LS47	14.75	23.5	8.75	Ninguno
911168	LS47	LS47	15	24	9	Ninguno
911173	S5	L1	10.25	15	4.75	P01167
911174	XP7	LS26	15.25	25.125	9.875	Ninguno
911175	L1	LS26	13.75	21.875	8.125	Ninguno
911176	XP7	LS26	16.75	28.25	11.5	Ninguno
911178	S4	SPEC	10.75	15.25	4.5	P01135
911181	S5	LS42	10.25	15.125	4.875	P01167
911186	S5	XP12	9.875	14.25	4.375	P01167
911187	LS47	LS47	16	26.5	10.5	Ninguno
911188	S5	LS47	10.75	15.875	5.125	P01167
911190	LS77	LS39	11.25	15.875	4.625	Ninguno
911191	S5	LS47	9.625	13.75	4.125	P01167
911192	LS47	LS47	15.75	26.125	10.375	Ninguno
911193	S5	LS47	14.25	22.25	8	P01167
911194	L1	LS26	16.625	28.125	11.5	Ninguno
911195	L1	LS26	14.25	22.875	8.625	Ninguno
911196	L1	LS26	18.25	31	12.75	Ninguno
911197	LS43	LS43	16.42	23.45	7.03	Ninguno
911198	S5	LS92	14.75	21.38	6.63	P01167
911199	LS92	LS92	17.18	27.69	10.51	Ninguno
911220	S4	LS26	9.75	14.75	5	P01135
911221	S5	XP12	11	16.375	5.375	P01167
911222	LS47	LS47	16.5	27.5	11	Ninguno
911223	S5	LS47	14.5	22.75	8.25	P01167
911228	XP7	LS47	13.375	21	7.625	Ninguno
911229	S4	LS21	10	14.5	4.5	P01134
911230	XP7	LS47	14.375	23	8.625	Ninguno
911255	S4	XP5	9.25	12.875	3.625	P01135
911256	S4	SPEC	10.875	15.125	4.25	P01136
911257	S4	XP5	9.875	14.125	4.25	P01136
911258	LS40	LS40	13.625	21.75	8.125	Ninguno
911259	LS29	LS23	11	16	5	Ninguno

Número de Parte	Códigos de Montura		Longitudes			Accesorios
	Sup.	Inf.	Comprimida	Extendida	Viaje	
<b>AMORTIGUADORES</b>						
911260	LS29	LS74	15.25	24	8.75	Ninguno
911261	LS39	LS39	15.5	25	9.5	Ninguno
911262	LS39	LS39	16.5	27.25	10.75	Ninguno
911265	L1	LS26	16.25	27	10.75	Ninguno
911266	S5	LS47	13.625	20.75	7.125	P01167
911267	L1	LS26	17.625	29.625	12	Ninguno
911268	L1	LS26	18.5	31.375	12.875	Ninguno
911277	LS28	LS28	14.75	24	9.25	Ninguno
911278	LS30	LS38	15.125	24.25	9.125	Ninguno
911299	LS47	LS47	16.42	26.09	9.67	Ninguno
911300	S5	XP10	9.63	14.33	4.7	P01167
911302	LS38	LS38	18.43	28.64	10.21	Ninguno
911303	LS92	LS92	16.25	25.875	9.625	Ninguno
911304	S2	CLEV	16.12	21.46	5.34	P00762
911330	CLEV	S5	18.64	24.8	6.16	P00590,P01637
911331	LS27	LS27	17.06	28.07	11.01	Ninguno
911332	LS27	LS27	17.81	29.44	11.63	Ninguno
911334	LS39	LS39	17.28	28.78	11.5	Ninguno
911335	LS39	LS39	17.89	29.69	11.8	Ninguno
911336	S5	LS47	14.86	24.26	9.4	P01167
911447	S2	CLEV	13.72	17.97	4.25	P01299
911501	S4	SPEC	10.875	15.375	4.5	P01136
911502	LS47	LS47	16.75	25.625	8.875	Ninguno
911503	S4	XP5	10.25	14.625	4.375	P01136
911504	LS47	LS47	15.375	24.125	8.75	Ninguno
911505	S4	SPEC	10.875	15.375	4.5	P01136
911506	LS47	LS47	15.375	23.75	8.375	Ninguno
911507	S4	LS42	12.5	15.5	3	P01136
911508	LS43	LS43	17.75	27.25	9.5	Ninguno
911511	LS77	LS39	11.375	16.625	5.25	Ninguno
911512	XP7	LS47	16	25.625	9.625	Ninguno
911514	LS39	LS39	11.375	16.625	5.25	Ninguno
911517	XP7	LS47	14.76	23.15	8.39	Ninguno
911527	S6	SPEC	11.125	15.375	4.25	P01136
911528	SPEC	LS47	15.375	24	8.625	Ninguno
911530	L1	L1	13	20.75	7.75	Ninguno
911533	LS43	LS43	15.83	24.8	8.97	Ninguno
911536	S4	LS26	14.02	21.93	7.91	P01136
911538	SPEC	LS26	14.69	22.56	7.87	Ninguno
911539	SPEC	LS27	14.76	23.15	8.39	Ninguno
911545	LS47	LS47	15.67	21.378	5.708	Ninguno
911546	LS47	LS47	15.492	21.248	5.756	Ninguno
911547	S4	LS23	14.606	22.834	8.228	P01137



## TABLA DE MEDIDAS

\*Longitudes en pulgadas

Número de Parte	Tipo de Cuerpo	Longitudes			Accesorios	
		Compimida	Extendida	Viaje		
<b>STRUTS</b>						
39104	S1	SPEC	14.513	18.06	3.547	P1415
39105	S1	SPEC	14.513	18.06	3.547	P1415
39106	S1	SPEC	14.51	18.05	3.54	P1415
39112	S1	XP16	13.9	17.125	3.25	P01415
39134			16.13	20.56	4.43	Ninguno
39135			17.16	22.15	4.99	Ninguno
39140			13.89	17.12	3.23	P01415
40047			12.75	17.16	4.41	Ninguno
40048			12.75	17.16	4.41	Ninguno
40049			12.75	17.16	4.41	Ninguno
71026			17.87	26.16	8.29	Ninguno
71027			12.99	18.42	5.43	Ninguno
71029			13.8	19.68	6.78	Ninguno
71030			18.89	28.11	9.22	Ninguno
71031			12.4	19.21	7.17	Ninguno
71032			12.4	19.21	7.17	Ninguno
71033			18.81	27.4	8.59	Ninguno
71036			15.08	21.07	5.99	BR11505018
71038			14.62	21.42	6.8	Ninguno
71039			18.23	26.18	7.95	Ninguno
71040			16.85	24.88	8.03	Ninguno
71041			14.06	20.8	6.74	BE17110546
71042			14.56	23.95	9.39	BE17110779
71048			10.31	15.1	4.79	Ninguno
71053			18.98	24.13	5.15	Ninguno
71054			14.74	21.34	6.6	Ninguno
71055			14.92	21.14	6.22	Ninguno
71056			12.4	18.86	6.46	Ninguno
71058			14.21	20.08	5.87	M17130024
71059			15.12	21.1	5.98	Ninguno
71060			15.12	21.1	5.98	Ninguno
71061			13.5	19.7	6.2	Ninguno
71062			13.5	16.7	3.2	Ninguno
71063			14.57	20.08	5.51	Ninguno
71100			13.56	18.39	4.83	Ninguno
71102			10.99	15.56	4.57	P01614
71103			10.99	15.56	4.57	P01614
71105			12.519	16.437	3.918	P00762
71106			12.519	16.437	3.918	P00762
71109			10.49	19.49	9	Ninguno
71110			14.591	19.488	4.897	Ninguno
71111			15.43	21.19	5.76	P01746
71112			12.008	16.457	4.449	P00522
71113			11.82	17.74	5.92	P00762
71114			10.55	15.04	4.49	P00906

Número de Parte	Tipo de Cuerpo	Longitudes			Accesorios	
		Compimida	Extendida	Viaje		
<b>STRUTS</b>						
71116			19.134	24.409	5.275	P00762
71117			19.134	24.409	5.275	P00762
71119			17.76	23.55	5.76	P01613
71122			14.646	20.157	5.511	P00906
71123			15.315	22.6	7.285	P00906
71124			19.32	20.42	1.1	P01611
71125			13.52	19.69	6.17	P01611
71126			13.13	20.64	7.51	P00906
71128			12.46	19.5	7.04	P00762
71130			12.091	19.604	7.513	P00762
71131			12.092	19.604	7.512	P00762
71135			14.14	20.81	6.67	P00762
71136			14.14	20.81	6.67	P00762
71137			17.68	22.25	4.57	P01613
71138			16.15	21.3	5.15	P01388
71139			15.43	21.11	5.68	P01388
71140			16.38	21.18	4.8	P01388
71141			17.17	21.64	4.47	P01769
71143			11.063	14.922	3.859	Ninguno
71144			11.063	14.922	3.859	Ninguno
71147			11.5	17.313	5.813	P00906
71265			16.5	25	8.5	P01006
71266			13.25	19.375	6.125	P00878
71267			17.75	25.25	7.5	P01249
71276			15	21	6	P01629
71278			11.18	16.67	5.49	Ninguno
71281			17.375	23.75	6.375	Ninguno
71285			13.375	18.125	4.75	P00942
71292			13.25	19.25	6	P00878
71293			12.51	17.73	5.22	P00906
71296			14.5	21.25	6.75	Ninguno
71297			12	19.25	7.25	P01498
71304			18.125	22	3.875	BE17110455
71309			15.125	23.25	8.125	BE17110467
71311			13.4	20.43	7.03	Ninguno
71312			11.5	16.5	5	Ninguno
71313			14.5	21.5	7	BE17110505
71321			16.54	19.06	2.52	P01611
71322			13.52	19.69	6.17	P01611
71326			15.75	22.375	6.625	P01629
71327			12.875	17.625	4.75	P01623
71331			19	24.5	5.5	P00838
71332			15.625	23.5	7.875	BE17110497
71334			13.75	18.625	4.875	BE17110616
71335			18.125	22	3.875	BE17110625



# TABLA DE MEDIDAS

\*Longitudes en pulgadas

Número de Parte	Tipo de Cuerpo	Longitudes			Accesorios	
		Compimida	Extendida	Viaje		
<b>STRUTS</b>						
71339			16.625	25.375	8.75	P00906
71340			10.375	14.75	4.375	BE17110696
71341			11.07	16.08	5.01	Ninguno
71344			17.75	20.375	2.625	P01708
71345			13.125	17.375	4.25	P01708
71346			12.25	15.52	3.27	P01611
71347			13.625	17.875	4.25	P01612
71349			15.5	23.25	7.75	BE17110549
71351			13.5	16.18	2.68	P01612
71352			13.62	18.19	4.57	P01612
71353			11.04	16.11	5.07	P01612
71354			10.375	13.125	2.75	P00762
71356			14.375	21	6.625	BE17110307
71357			12.92	18.69	5.77	Ninguno
71358			10.99	15.38	4.39	P01614
71359			11.625	16.25	4.625	Ninguno
71361			17.3	21.63	4.33	P01760
71362			15.77	20.71	4.94	P01760
71363			11.75	16	4.25	P00762
71366			17.875	21.625	3.75	BE17110547
71368			17.75	20.375	2.625	P01708
71371			16.89	22.39	5.5	P01613
71373			11.5	16.5	5	P00839
71377			14.07	20.32	6.25	Ninguno
71379			11.125	17.375	6.25	P01629
71380			11.02	15.71	4.69	P00906
71381			12.125	17	4.875	P00906
71391			11.813	18.5	6.687	BE17110629
71400			12.625	18.75	6.125	P00762
71401			12.625	18.75	6.125	P00762
71404			13.375	19.625	6.25	P00762
71405			13.375	19.625	6.25	P00762
71410			17.5	25.125	7.625	Ninguno
71416			14.75	22.5	7.75	Ninguno
71417			12	16.75	4.75	P00906
71424			12.99	20.08	7.09	P00762
71425			12.99	20.08	7.09	P00762
71426			13.625	20.5	6.875	P00762
71427			13.625	20.5	6.875	P00762
71435			16.375	23	6.625	P00762
71436			16.375	23	6.625	P00762
71453			15.5	22.75	7.25	P00808
71454			15.5	22.75	7.25	P00808
71455			10.25	15.5	5.25	BE17110666
71456			10.25	15.5	5.25	BE17110666

Número de Parte	Tipo de Cuerpo	Longitudes			Accesorios	
		Compimida	Extendida	Viaje		
<b>STRUTS</b>						
71461			14.47	21.1	6.63	P00762
71462			14.47	21.1	6.63	P00762
71483			13.625	20	6.375	BE17110461
71484			13.625	20	6.375	BE17110461
71485			14.125	20.75	6.625	BE17110535
71486			16.125	20.25	4.125	BE17110693
71488			16.125	19.5	3.375	BE17110693
71490			14.5	21.75	7.25	Ninguno
71492			15.84	24.49	8.65	P00808
71493			15.84	24.49	8.65	P00808
71496			16.71	24.35	7.64	P00808
71497			16.71	24.35	7.64	P00808
71498			15.26	23.3	8.04	P00808
71499			15.26	23.3	8.04	P00808
71504			13.98	20.28	6.3	BE17110533
71505			13.98	20.28	6.3	P00762
71515			17	22.25	5.25	P00808
71525			15.25	22	6.75	P00808
71565			9.99	13.33	3.34	P01095
71566			12.875	18.75	5.875	P00762
71567			12.875	18.75	5.875	P00762
71568			14.25	20.25	6	P00762
71570			16.625	23.375	6.75	P00762
71571			16.625	23.375	6.75	P00762
71572			11.46	18.56	7.1	Ninguno
71573			16	22.625	6.625	P00762
71575			13.375	20.5	7.125	BE17110543
71577			9.625	13.875	4.25	Ninguno
71580			12	18	6	Ninguno
71581			15	19.5	4.5	BE17110432
71582			15	19.5	4.5	BE17110432
71584			14	22.5	8.5	P00762
71586			13	20	7	P00762
71587			13	20	7	P00762
71588			15	23.375	8.375	P00762
71589			15	23.375	8.375	P00762
71590			8.75	15.25	6.5	P00808
71591			8.78	15.22	6.74	P00808
71592			12	18	6	Ninguno
71593			17.75	25	7.25	P00590
71594			17.75	25	7.25	P00590
71595			13.125	19.125	6	Ninguno
71596			13.125	19.125	6	Ninguno
71597			14.5	21	6.5	P00762
71598			14.5	21	6.5	P00762



# TABLA DE MEDIDAS

\*Longitudes en pulgadas

Número de Parte	Tipo de Cuerpo	Longitudes			Accesorios	
		Compimida	Extendida	Viaje		
<b>STRUTS</b>						
71612			15.5	24	8.5	P00762
71613			15.5	24	8.5	P00762
71615			13.81	17.94	4.13	P00590
71628			12.25	18	5.75	Ninguno
71629			12.25	18	5.75	Ninguno
71642			13.875	21.25	7.375	BE17110307
71654			12.875	18.875	6	P00762
71655			12.875	18.875	6	P00762
71661			10.27	16.68	6.41	Ninguno
71662			15.53	23.09	7.56	P01700
71663			15.52	23.09	7.57	Ninguno
71664			11	18.5	7.5	Ninguno
71667			11.125	17.375	6.25	P01455
71668			11.125	17.375	6.25	P01455
71669			17.9	26.69	9	P01456
71671			15.58	21.86	6.28	P01700
71674			13.375	18.875	5.5	P00839
71675			13.375	18.875	5.5	P00839
71676			15.375	22.25	6.875	P00839
71677			15.375	22.25	6.875	P00839
71678			13.88	20.12	6.24	Ninguno
71680			16.31	24.21	7.9	Ninguno
71681			16.31	24.21	7.9	Ninguno
71684			10.375	17.5	7.125	Ninguno
71685			10.125	16.5	6.375	Ninguno
71686			12.125	20.375	8.25	Ninguno
71687			12.95	18.98	6.03	P00762
71691			16.625	19.5	2.875	P00906
71697			13	17.625	4.625	BE17110417
71698			13.75	18.375	4.625	BE17110417
71699			14.375	20.625	6.25	BE17110430
71716			14	19.5	5.5	P00589
71728			10.25	17.4	7.15	Ninguno
71771			10.3	16.91	6.61	Ninguno
71803			13.625	20.125	6.5	P01453
71808			17.375	24.25	6.875	BE17110394
71814			9.375	16.125	6.75	Ninguno
71828			13.625	20.125	6.5	P01454
71829			11.125	15.25	4.125	P00906
71844			12.125	16.5	4.375	P00906
71846			14.5	22.625	8.125	P00808
71847			14.5	22.625	8.125	P00808
71852			13.375	20.25	6.875	P00839
71853			13.54	20.47	6.93	P00986
71854			10.84	17.7	6.86	P00853

Número de Parte	Tipo de Cuerpo	Longitudes			Accesorios	
		Compimida	Extendida	Viaje		
<b>STRUTS</b>						
71859			13.375	19.625	6.25	Ninguno
71871			13.375	19.625	6.25	Ninguno
71872			13.375	19.625	6.25	Ninguno
71873			14.875	23.125	8.25	Ninguno
71874			14.875	23.125	8.25	Ninguno
71893			12.5	20	7.5	P00808
71894			12.5	20	7.5	P00808
71897			12.75	16.375	3.625	P01095
71898			12.625	18.75	6.125	P00808
71899			12.625	18.75	6.125	P00808
71900			14.25	20.25	6	Ninguno
71901			14.21	20.22	6.02	Ninguno
71918			12.25	17.875	5.625	P00839
71920			14.75	21.125	6.375	P01700
71924			10.23	17.08	6.85	P01328
71925			12.625	19.625	7	P01328,P01329
71933			13.875	20.5	6.625	P00986
71943			15	22.25	7.25	P00839
71944			15	22.25	7.25	P00839
71951			13.25	18.75	5.5	P00808
71952			13.25	18.75	5.5	P00808
71953			15.5	22.5	7	P00808
71954			15.43	22.5	7.07	P00808
71962			12.83	18.49	5.66	P00589
71963			12.875	18.5	5.625	P00589
71964			13	19.55	6.55	P00590
71966			15	22	7	Ninguno
71968			14.375	20.125	5.75	Ninguno
71969			14.375	20.125	5.75	Ninguno
71972			12.43	19.875	7.445	Ninguno
71984			16.875	26.125	9.25	P00762
72105			12.75	18.75	6	P00762
72106			12.75	18.75	6	P00762
72107			12.75	18.75	6	P00762
72108			12.75	18.75	6	P00762
72114			13.39	20.43	7.04	Ninguno
72115			13.39	20.43	7.04	Ninguno
72116			13.6	20.64	7.04	P00808
72117			13.47	20.64	7.17	P00808
72123			12.5	17.125	4.625	P00906
72127			15.75	22.875	7.125	P00808
72130			13.38	20.8	7.42	Ninguno
72136			14.37	21.5	7.13	P00762
72138			16.09	21.63	5.54	P00590
72141			14.25	21	6.75	P00762



# TABLA DE MEDIDAS

\*Longitudes en pulgadas

Número de Parte	Tipo de Cuerpo	Longitudes			Accesorios	
		Compimida	Extendida	Viaje		
<b>STRUTS</b>						
72142			13	21	8	P00762
72143			14.53	21.1	6.6	P00762
72144			14.4	21.1	6.7	P00762
72147			13.35	19.11	5.76	P00762
72148			13.35	19.11	5.76	P00762
72170			14.45	21.34	6.89	P00808
72177			10.325	16.625	6.3	Ninguno
72178			13.622	20.709	7.087	P00808
72179			11.55	17.6	6.05	P01460
72185			13.375	19.875	6.5	P00762
72186			13.375	19.875	6.5	P00762
72191			14	20.375	6.375	P00762
72192			14	20.375	6.375	P00762
72193			14.875	22.25	7.375	P00762
72194			14.875	22.375	7.5	P00762
72195			13.972	19.091	5.119	P01523
72199			11.55	17.91	6.36	P01460
72200			13.75	20.5	6.75	P01460
72205			14.5	21.75	7.25	P01418
72207			15.97	24.49	8.52	P00808
72208			16.375	24.5	8.125	P00808
72209			12.87	20.94	8.07	P00590
72210			12.87	20.94	8.07	P00590
72211			16.95	23.72	6.77	P01418
72212			16.95	23.72	6.77	P01418
72213			17.32	24.31	6.99	P00808
72214			17.3203	24.31	6.99	P00808
72215			15.39	22.91	7.52	P00808
72216			15.39	22.91	7.52	P00808
72219			14.97	21.4	6.43	P00762
72220			14.97	21.4	6.43	P00762
72221			15.75	23.33	7.58	P00762
72222			15.75	23.33	7.58	P00762
72229			14.48	21.69	7.21	P00762
72230			14.48	21.69	7.21	P00762
72231			10.14	16.68	6.54	Ninguno
72237			16.54	23.82	7.28	P01418
72238			13.38	19.09	5.71	P00762
72240			13.62	20.49	6.87	P00762
72241			13.62	20.49	6.87	P00762
72245			14.724	20.59	5.866	P00762
72248			19.83	24.98	5.15	P01522
72254			12.34	17.5	5.16	P01524
72257			13.69	19.96	6.27	P00762
72258			14	20.125	6.125	P00762

Número de Parte	Tipo de Cuerpo	Longitudes			Accesorios	
		Compimida	Extendida	Viaje		
<b>STRUTS</b>						
72261			13.54	18.01	4.47	P01523
72263			12.25	18.9375	6.688	P00762
72264			12.25	18.9375	6.688	P00762
72265			15.125	21	5.875	BE17110787
72266			15.125	21	5.875	BE17110787
72267			15.04	22.21	7.17	P00762
72268			15.04	22.21	7.17	P00762
72271			14.25	21.5625	7.313	P00762
72272			14.25	21.5625	7.313	P00762
72275			15.12	20.98	5.86	P00808
72276			15.12	20.98	5.86	P00808
72281			12.91	16.56	3.65	P00906
72283			14.3	20.15	5.85	Ninguno
72286			10.43	17.36	6.93	P00762
72287			10.43	17.36	6.93	P00762
72288			15.45	21.54	6.09	P00762
72289			15.45	21.54	6.09	P00762
72290			12.56	18.25	5.69	P00762
72291			12.56	18.25	5.69	P00762
72292			15.4375	21.625	6.187	P01746
72293			16.563	19.5	2.937	P01611
72294			13.52	19.36	5.84	P01611
72295			13.39	20.12	6.73	P00808
72296			13.39	20.12	6.73	P00808
72297			12.9375	19.25	6.312	P00762
72298			12.9375	19.25	6.312	P00762
72301			13.3125	19.6875	6.375	P00762
72303			14.3125	22.25	7.937	P00762
72304			13.03	19.4	6.38	P00762
72305			13.1875	19.8125	6.625	P00762
72306			13.1875	19.8125	6.625	P762
72307			14.57	21.5	6.93	P01418
72308			14.57	21.5	6.93	P01418
72309			16	24.063	8.063	P00808
72310			16	24.0625	8.063	P00808
72311			15.375	21.75	6.375	BE17110546
72312			15.375	21.75	6.375	BE17110753
72313			9.5	14.0625	4.563	P00838
72314			9.5	14.0625	4.5625	P00838
72315			12.25	18.688	6.438	P00762
72316			12.188	18.688	6.5	P00762
72317			15.625	22.125	6.5	P00762
72318			15.625	22.125	6.5	P00762
72319			15.375	23.6875	8.3125	P00762
72320			15.375	23.6875	8.3125	P00762



## TABLA DE MEDIDAS

\*Longitudes en pulgadas

Número de Parte	Tipo de Cuerpo	Longitudes			Accesorios	
		Compimida	Extendida	Viaje		
<b>STRUTS</b>						
72322			12.313	16.688	4.375	P00906
72324			17.188	24.75	7.562	P00906
72327			14.0625	19.5	5.437	P01371
72328			14.0625	19.5	5.437	P01371
72332			12.063	19.625	7.562	P00762
72333			12.0625	18.875	6.812	P00762
72343			14.938	21.25	6.312	Ninguno
72347			14.625	21.5625	6.938	Ninguno
72348			14.625	21.5625	6.938	Ninguno
72351			14.875	18.9375	4.0625	Ninguno
72352			14.875	18.9375	4.0625	Ninguno
72355			14.3125	21.5625	7.25	Ninguno
72356			14.3125	21.5625	7.25	Ninguno
72357			13.9375	20.5	6.562	P01418
72358			14	20.5	6.500	P01418
72362			14.9375	19.0625	4.125	P01607
72367			13.54	20.08	6.54	Ninguno
72368			13.54	20.08	6.54	Ninguno
72371			12.3125	17.8125	5.5	Ninguno
72372			12.3125	17.8125	5.5	Ninguno
72374			14.291	21.771	7.48	Ninguno
72378			13.1	19.8	6.7	P00762
72379			13.1	19.8	6.7	P00762
72384			16.4375	22.0625	5.625	P00808
72385			16.0625	22.0625	6	P00808
72390			13.25	20.59	7.34	P01418
72391			13.25	20.59	7.34	P01418
72392			13.63	17.43	3.8	Ninguno
72393			13.63	17.43	3.8	Ninguno
72397			12.625	19.5625	6.9375	Ninguno
72398			12.5625	18.3125	5.75	Ninguno
72399			12	17.4375	5.4375	Ninguno
72400			11.188	13.25	2.062	Ninguno
72401			12.44	18.98	6.54	P00906
72408			19.83	24.98	5.15	P01522
72418			15.688	22.875	7.187	P00762
72423			15.6875	22.75	7.062	Ninguno
72424			15.5625	22.75	7.187	Ninguno
72425			15.4375	21.125	5.687	Ninguno
72426			15.4375	20.75	5.312	Ninguno
72433			15.1875	20.125	4.937	Ninguno
72434			15.2031	20.1563	4.95313	Ninguno
72437			15.75	20.9375	5.1875	Ninguno
72438			15.75	20.938	5.188	Ninguno
72445			17.9375	25.3125	7.375	Ninguno

Número de Parte	Tipo de Cuerpo	Longitudes			Accesorios	
		Compimida	Extendida	Viaje		
<b>STRUTS</b>						
72446			17.9375	25.3125	7.375	Ninguno
72450			14.9688	22.3594	7.39	Ninguno
72451			14.9688	22.3594	7.39	Ninguno
72465			14.375	21.375	7	Ninguno
72468			13.8281	19.1719	5.344	Ninguno
72469			13.875	19.1875	5.313	Ninguno
72476			21.38	26.3	4.92	P01363
72477			21.38	26.3	4.92	P01363
72478			15.43	21.3	5.87	P01363
72479			14.33	20.43	6.1	BE17110589
72480			11.02	16.46	5.44	BE17110613
72481			11.02	16.46	5.44	BE17110613
72482			11.61	16.42	4.81	BE17110715
72483			17.15	23.76	6.61	P01418
72484			17.15	23.76	6.61	P01418
72485			18.957	26.339	7.382	P00808
72486			18.957	26.339	7.382	P00808
72489			17.421	24.547	7.126	P00808
72490			17.421	24.547	7.126	P00808
72491			12.16	20.55	8.39	Ninguno
72492			12.16	20.55	8.39	Ninguno
72493			17.2	25.72	8.52	P01371
72494			17.2	25.72	8.52	P01371
72496			13.89	21.34	7.45	P00906
72497			11.02	15.55	4.53	P00906
72501			10.94	16.3	5.36	Ninguno
72504			14.31	21.56	7.25	Ninguno
72508			11.97	17.4	5.43	Ninguno
72509			12.46	18.81	6.35	P00762
72510			12.46	18.81	6.35	P00762
72511			14.01	21.41	7.4	P00906
72516			14.12	19.86	5.74	Ninguno
72517			13.44	18.39	4.95	P01630, P01650
72518			11.27	19.12	7.85	Ninguno
72519			13.11	18.66	5.55	BE17110539
72520			13.11	18.66	5.55	BE17110539
72521			14.37	21.26	6.89	BE17110659
72522			11.89	18.33	6.44	P00762
72523			11.89	18.33	6.44	P00762
72524			13.386	20.039	6.653	P00762
72525			13.386	20.039	6.653	P00762
72526			13.52	21.03	7.51	P00590
72527			13.52	21.03	7.51	P00590
72528			13.72	19.51	5.79	Ninguno



# TABLA DE MEDIDAS

\*Longitudes en pulgadas

Número de Parte	Tipo de Cuerpo	Longitudes			Accesorios	
		Compimida	Extendida	Viaje		
<b>STRUTS</b>						
72529			13.72	19.51	5.79	Ninguno
72532			12.1	19.22	7.12	P00590
72533			14.45	21.81	7.36	P00590
72534			11.95	19.22	7.27	P01697
72535			11.95	19.22	7.27	P01697
72536			14.79	22.18	7.39	P00762
72537			14.79	22.18	7.39	P00762
72538			11.88	18.57	6.69	P01684
72539			12.58	18.12	5.54	P01685
72540			15.61	22.13	6.52	P00590
72541			13.87	22.44	8.57	P00762
72542			13.87	22.44	8.57	P00762
72544			13.39	20.03	6.64	P00762
72545			13.39	20.03	6.64	P00762
72546			26.91	30.69	3.78	P01748
72547			12.48	19.21	6.73	P01418
72548			12.48	19.21	6.73	P01418
72549			15.39	21.77	6.38	BE17110753
72560			13.85	20.67	6.82	P00762
72561			13.85	20.67	6.82	P00762
72562			9.99	15.35	5.36	P00906
72563			11.52	16.352	4.832	P00762,P00906
72567			10.48	16.261	5.781	Ninguno
72568			13.54	19.07	5.53	P01523
72569			13.54	19.07	5.53	P01523
72576			11.94	18.1	6.16	P00590
72577			11.94	18.1	6.16	P00590
72585			13.81	20.76	6.95	P00762
72586			13.81	20.76	6.95	P00762
72587			13.66	20.66	7	P00762
72588			13.66	20.66	7	P00762
72589			10.8	17.31	6.51	Ninguno
72591			12.22	18.74	6.52	Ninguno
72595			12.87	19.28	6.41	P01685
72596			13.54	18.01	4.47	P01523
72597			13.39	20.57	7.18	P01418
72598			13.39	20.57	7.18	P01418
72599			12.23	16.62	4.39	P00839
72600			11.22	13.87	2.65	P00839
72601			14.56	21.65	7.09	BE17110630
72602			12.28	18.86	6.58	BE17110629
72603			13.97	20.78	6.81	P1371
72604			13.51	20.08	6.48	Ninguno
72605			13.51	20.08	6.57	Ninguno
72606			16.25	20.96	4.71	Ninguno

Número de Parte	Tipo de Cuerpo	Longitudes			Accesorios	
		Compimida	Extendida	Viaje		
<b>STRUTS</b>						
72607			16.25	20.96	4.71	Ninguno
72608			15.44	24.11	8.67	P00839
72609			15.44	24.18	8.74	P00839
72610			11.95	18.1	6.15	P00590
72612			11.58	17.59	6.01	P00590
72613			11.58	17.59	6.01	P00590
72618			12.36	18.58	6.22	P00762
72619			12.36	18.58	6.22	P00762
72620			11.8	22.95	11.15	P00590
72621			11.8	22.95	11.15	P00590
72623			13.78	19.685	5.905	P00839
72626			15.19	24.6	9.41	P01742
72627			15.19	24.6	9.41	P01742
72631			11.25	17.38	6.13	Ninguno
72632			11.25	17.38	6.13	Ninguno
72633			13.97	20.78	6.81	P1371
72634			15.19	22.03	6.84	BE17110468
72635			15.04	19.29	4.25	P00808
72637			12.05	17.99	5.94	P00762
72638			14.02	20.72	6.7	P00762
72639			13.03	18.49	5.46	P00762
72641			11.28	17.4	6.12	P00762
72642			13.49	20.77	7.28	P00762
72644			16.20	22.59	6.38	P00762
72645			16.20	22.59	6.38	P00762
72647			17.598	24.665	7.067	P00762
72648			17.598	24.665	7.067	P00762
72651			16.47	20.89	4.42	P01388,P01726
72652			17.18	21.63	4.45	P01388,P01726
72653			14.3	21.18	6.88	P01697
72654			14.3	21.18	6.88	P01697
72663			15.33	24.6	9.27	P01742
72664			15.33	24.6	9.27	P01742
72665			20.36	25.5	5.14	P01522
72668			14.13	20.35	6.22	P00762
72669			14.13	20.35	6.22	P00762
72670			13.28	19.43	6.15	Ninguno
72671			13.28	19.43	6.15	Ninguno
72678			15.43	21.3	5.87	Ninguno
72679			15.43	21.3	5.87	Ninguno
72680			13.42	19.76	6.3	Ninguno
72681			13.42	19.76	6.3	Ninguno
72682			13.44	19.37	5.93	P00808
72683			13.44	19.37	5.93	P00808
72684			14.76	20.83	6.07	Ninguno





# TABLA DE MEDIDAS

\*Longitudes en pulgadas

Número de Parte	Tipo de Cuerpo	Longitudes			Accesorios	
		Compimida	Extendida	Viaje		
<b>STRUTS</b>						
72685			14.76	20.83	6.07	Ninguno
72686			17.2	22.6	5.4	Ninguno
72687			17.2	22.6	5.4	Ninguno
72688			13.5	19.6	6.1	Ninguno
72689			13.5	19.6	6.1	Ninguno
72690			11.34	16.65	5.31	Ninguno
72691			14.75	19	4.25	Ninguno
72692			16.38	23.07	6.69	Ninguno
72693			12.36	17.14	4.78	Ninguno
72695			13.22	18.9	5.68	Ninguno
72696			11.14	17	5.86	Ninguno
72699			14.54	19.84	5.3	P00906
72702			12.83	17.48	4.65	P00762
72703			12.83	17.48	4.65	P00762
72706			13.35	19.57	6.22	P00762
72707			13.35	19.57	6.22	P00762
72708			13.55	19.07	5.52	P00762
72709			13.55	19.07	5.52	P00762
72720			14.2	20.27	6.07	P00762
72721			14.2	20.27	6.07	P00762
72722			14.49	21.5	7.02	P00762
72723			14.49	21.5	7.02	P00762
72729			11.8	22.87	11.07	P00590
72730			11.8	22.87	11	P00590
72731			9.65	16.81	7.16	P01371
72732			9.65	16.81	7.16	P01371
72733			9.65	16.34	6.69	P01371
72734			9.65	16.34	6.69	P01371
72738			13.5	20.34	6.84	P00762
72739			14.5	21.5	6.98	P01418
72740			14.5	21.5	6.98	P01418
72743			11.19	17.22	6.03	P00762
72746			14.88	22.68	7.8	P00838
72748			12.36	19.37	7.01	P00762
72749			12.36	19.37	7.01	P00762
72750			12.36	19.37	7.01	P00762
72751			12.36	19.37	7.01	P00762
72753			12.36	19.37	7.01	P00762
72755			9.53	15.75	6.22	P00838
72756			9.53	15.75	6.22	P00838
72761			11.95	19.22	7.27	P00590,P01717
72762			15.88	23.07	7.19	P00590,P01717
72765			16.26	22.44	6.18	Ninguno
72766			16.26	22.44	6.18	Ninguno
72770			15.43	17.85	2.42	Ninguno

Número de Parte	Tipo de Cuerpo	Longitudes			Accesorios	
		Compimida	Extendida	Viaje		
<b>STRUTS</b>						
72772			15.41	22.81	7.4	Ninguno
72773			15.41	22.81	7.4	Ninguno
72774			11.19	17.89	6.7	P00762
72775			11.19	17.89	6.7	P00762
72778			11.02	17.68	6.66	P00762
72779			11.02	17.68	6.66	P00762
72780			12.35	16.81	4.46	P00762
72781			16.31	23.8	7.49	P01418
72782			16.31	23.8	7.49	P01418
72785			11.02	17.48	6.46	P00762
72786			11.02	17.48	6.46	P00762
72787			9.98	17.43	7.45	P00762
72788			9.98	17.43	7.45	P00762
72789			14	19.51	15.51	P00808
72790			14.39	19.51	5.12	P00808
72888			17.02	24.13	7.11	P00590
72889			17.02	24.13	7.11	P00590
72894			12.33	19.11	6.78	P00906
72895			13.87	21.45	7.58	P00906
72896			12.33	19.11	6.78	P00906
72899			12.86	16.93	4.07	P01524
72900			16.21	20.06	3.84	P01726
72901			13.58	18.11	4.53	P00762
72902			13.58	18.11	4.53	P00762
72903			10.14	16.68	6.41	P00590
72907			11.2	17.9	6.7	P00762
72908			11.2	17.9	6.7	P00762
72909			12.26	19.05	6.79	P00808
72910			13.72	19.89	6.17	P01742
72911			13.72	19.89	6.17	P01742
72913			13.03	19.41	6.38	P00808
72915			13.03	19.41	6.38	P00808
72916			16.06	21.5	5.44	Ninguno
72918			15.48	23.46	7.98	Ninguno
72919			14.56	19.37	4.81	P01431
72921			17.02	25.33	8.31	P00590
72922			12.81	16.68	3.87	Ninguno
72923			11.31	17.43	6.12	P00762
72924			11.31	17.44	6.13	P00762
72925			11.09	19.98	8.89	P00762
72926			11.09	19.98	8.89	P00762
72927			11.09	15.94	4.85	P00762
72928			11.09	15.94	4.85	P00762
72929			14.04	21.149	7.109	P01700
72930			10.85	18.39	7.54	P00762



# TABLA DE MEDIDAS

\*Longitudes en pulgadas

Número de Parte	Tipo de Cuerpo	Longitudes			Accesorios
		Compimida	Extendida	Viaje	
<b>STRUTS</b>					
72931			10.85	18.39	7.54 P00762
72932			9.63	17.63	8 P00762
72933			9.63	17.63	8 P00762
72934			15.17	19.74	4.57 P01742
72935			14.93	19.51	4.58 P01742
72936			16.28	21.54	5.26 P00762
72937			16.28	21.54	5.26 P00762
72938			13.56	21.19	7.63 P00762
72939			13.56	21.19	7.63 P00762
72940			14.57	21.46	6.96 P01418
72941			14.57	21.46	6.96 P01418
72942			16.01	23.97	7.96 P00808
72943			16.01	23.97	7.96 P00808
72944			16.25	20.79	4.54 P00838
72945			12.22	18.91	6.69 Ninguno
72946			12.22	18.91	6.69 Ninguno
72947			13.82	17.48	3.66 P00762
72948			13.82	17.48	3.66 P00762
72949			11.23	17.66	6.43 Ninguno
72950			13.44	17.57	4.13 Ninguno
72951			13.44	17.57	4.13 Ninguno
72952			13.01	17.31	4.3 P00906
72955			16.28	20.95	4.67 P00762
72956			16.28	20.95	4.67 P00762
72957			12.41	16.83	4.42 P00906
72960			13.425	18.059	4.634 P00762
72961			13.425	18.059	4.634 P00762
72962			15.96	23.28	7.32 P01418
72963			15.96	23.28	7.32 P01418
72968			15.02	21.35	6.33 P00762
72969			15.02	21.35	6.33 P00762
72970			11.53	16.31	4.78 P00839
72971			11.53	16.31	4.78 P00839
72974			14.54	21.75	7.21 P00762
72975			14.54	21.75	7.21 P00762
72976			13.724	17.242	3.518 P01742
72977			13.724	17.242	3.518 P01742
72978			15.54	23.67	8.13 P00762
72979			15.54	23.67	8.13 P00762
72982			15.2	22.36	7.16 P00762
72983			15.2	22.36	7.16 P00762
72984			16.33	22.45	6.12 P00906
72985			13.65	20.8	7.15 P00762
72986			13.65	20.8	7.15 P00762
72989			13.52	20.16	6.64 P01418

Número de Parte	Tipo de Cuerpo	Longitudes			Accesorios
		Compimida	Extendida	Viaje	
<b>STRUTS</b>					
72990			13.52	20.16	6.64 P01418
72991			12.464	16.622	4.158 P00839
72992			14.57	19.78	5.19 P01418
72993			14.57	18.78	4.21 P01418
72994			13.93	20.35	6.41 P00762
72996			16.14	23.62	7.48 P00762
72997			15.14	22.75	7.61 P00762
72998			15.14	22.75	7.61 P00762
72999			14.72	21.53	6.81 P00808
73000			13.59	20.31	6.72 P01371
73001			13.59	20.31	6.72 P01371
73004			15.78	23.18	7.39 P01371
73005			15.78	23.18	7.39 P01371
73006			17.53	26.73	9.19 P01371
73007			17.53	26.73	9.19 P01371
73008			15.41	21.77	6.35 P01205
73009			14.63	22.05	7.42 P00762
73010			14.63	22.05	7.42 P00762
73012			14.17	19.23	5.06 P01700
73013			15.137	21.003	5.866 P00808
73014			15.137	21.003	5.866 P00808
73015			13.7	21.39	7.69 P00762
73016			13.7	21.39	7.69 P00762
73017			12.66	19.09	6.433 Ninguno
73018			12.66	19.09	6.433 P00762
73019			14.13	19.29	5.16 P00808
73020			14.13	19.29	5.16 P00808
73021			15.059	22.874	7.815 P01524
73022			15.059	22.874	7.815 P01524
73023			15.354	24.606	9.252 P01524
73024			15.354	24.606	9.252 P01524
73029			11.299	15.681	4.382 Ninguno
73030			11.299	15.681	4.382 Ninguno
73031			16.02	20.91	4.89 P01726
73032			17.17	22.09	4.92 P01726
73033			16.2	21.59	5.39 P00808
73034			16.2	24.28	8.08 P00808
73038			12.087	15.594	3.507 Ninguno
73039			13.661	19.397	5.736 P0906
73040			17.204	25.374	8.17 P00762
73041			17.204	25.374	8.17 P00762
73042			12.57	19.65	7.08 P00762
73043			12.57	19.65	7.08 P00762
73044			12.96	20.9	7.94 P00762
73045			12.71	18.78	6.07 Ninguno



# TABLA DE MEDIDAS

\*Longitudes en pulgadas

Número de Parte	Tipo de Cuerpo	Longitudes			Accesorios	
		Compimida	Extendida	Viaje		
<b>STRUTS</b>						
73046			12.71	18.78	6.07	Ninguno
73047			13.03	18.49	5.46	P00762
73048			10.94	14.96	4.02	P01614
73049			16.318	23.799	7.481	P01418
73050			16.318	23.799	7.481	P01418
73051			13.448	17.724	4.276	P01371
73052			13.448	17.724	4.276	P01371
73053			12.767	19.145	6.378	Ninguno
73054			12.767	19.145	6.378	Ninguno
73055			12.767	19.145	6.378	Ninguno
73056			12.767	19.145	6.378	Ninguno
73057			12.29	18.54	6.25	Ninguno
73058			12.29	18.54	6.25	Ninguno
73059			15.58	22.35	6.55	P00590
73060			13.91	20.64	6.73	P01371
73061			13.91	20.64	6.73	P01371
73062			15.05	19.17	4.12	P01371
73063			15.05	19.17	4.12	P01371
73066			14.3	21	6.7	P00762
73067			14.3	21	6.7	P00762
73068			15.56	19.45	3.89	P00839
73069			15.56	19.45	3.89	P00839
73070			15.41	19.21	3.8	P00839
73071			15.41	19.21	3.8	P00839
73072			14.33	20.96	6.63	P00808
73073			14.33	20.96	6.63	P00808
73074			12.39	17.71	5.32	P00762
73075			12.39	17.71	5.32	P00762
73076			17.307	21.292	3.985	P01613
73079			14.77	20.83	6.06	P00839
73080			14.77	20.83	6.06	P00839
73081			9.82	16.68	6.86	P00762
73082			12.86	15.78	2.92	P00906
73083			12.72	17.53	4.81	P00906
73084			13.53	19.59	6.06	P01796
73085			13.53	18.94	5.41	P01798
73086			17.5	24.81	7.31	P00762, P00906
73087			17.5	24.81	7.31	P00762, P00906
73088			16	22.06	6.06	P01418
73089			16	22.06	6.06	P01418
73090			14.653	19.448	4.795	P01371
73091			14.653	19.448	4.795	P01371
73092			16.16	21.55	5.39	P01418
73093			16.16	21.55	5.39	P01418

Número de Parte	Tipo de Cuerpo	Longitudes			Accesorios	
		Compimida	Extendida	Viaje		
<b>STRUTS</b>						
73094			15.86	21.32	5.44	P01418
73095			15.86	21.32	5.44	P01418
73099			14.15	20.36	6.21	P00762
73100			14.15	20.36	6.21	P00762
73116			13.6	20.64	7.04	P00808
400000			17.87	26.16	8.29	Ninguno
400001			12.99	18.42	5.43	Ninguno
400002			12.28	18.86	6.58	BE17110629
400003			13.97	20.78	6.81	P1371
400004			14.17	20.07	5.9	BE17110604
400005			13.22	20.39	7.17	Ninguno
400007			9.625	13.875	4.25	Ninguno
400008			13.1	19.8	6.7	P00762
400009			13.1	19.8	6.7	P00762
400010			12.091	19.604	7.513	P00762
400011			12.092	19.604	7.512	P00762
400012			11.89	18.33	6.44	P00762
400013			11.89	18.33	6.44	P00762
400014			13.85	20.47	6.62	P839
400015			15.12	20.98	5.86	P00808
400016			15.12	20.98	5.86	P00808
400017			15.23	21.29	6.06	BR11505022
400018			11.27	19.12	7.85	Ninguno
400019			11.55	17.91	6.36	P01460
400020			11.55	17.91	6.36	P01460
400021			15.375	21.75	6.375	BE17110546
400022			11.5	18.5	7	P590
400023			13.13	26.64	7.51	P00906
400025			18.89	28.11	9.22	Ninguno
400026			13.52	21.03	7.51	P00590
400027			13.52	21.03		P00590
400028			13.39	19.18	5.79	BR11505018
400029			13.8	19.68	6.78	Ninguno
400030			12.9375	19.25	6.312	P00762
400031			12.9375	19.25	6.312	P00762
400032			15.375	21.75	6.375	BE17110753
400033			12.44	18.98	6.54	P00906
400034			13.54	20.08	6.54	Ninguno
400035			13.54	20.08	6.54	Ninguno
400105			12.75	18.75	6	P762
400106			12.75	18.75	6	P762
400265			16.5	25.03	8.53	P01006
400295			13.75	20.063	6.313	P808
400296			13.75	20.063	6.313	P808
400312			11.5	16.5	5	P01623



# TABLA DE MEDIDAS

\*Longitudes en pulgadas

Número de Parte	Tipo de Cuerpo	Longitudes			Accesorios	
		Compimida	Extendida	Viaje		
<b>STRUTS</b>						
400426			13.625	20.5	6.875	P762
400427			13.625	20.5	6.875	P762
400525			15.25	22	6.75	P808
400871			13.42	19.68	6.26	Ninguno
400872			13.42	19.68	6.26	Ninguno
400873			14.88	23.07	8.19	Ninguno
400874			14.88	23.07	8.19	Ninguno
400933			13.54	20.47	6.93	P00986
400964			13.25	19.5	6.25	P1438
401044			13.98	20.28	6.3	BE17110533
401045			13.98	20.28	6.3	P00762
553003	S4	SPEC	10.83	17.91	7.08	Ninguno
553005			14.75	22.98	8.23	P00762
553006			14.75	22.34	7.59	P00762
553007			13.22	17.94	4.72	P00808
553014			20.22	25.6	5.28	P01522
553023			16.06	23.21	7.15	P00590
553024			11.8	22.33	10.53	P00590
553025			11.8	22.33	10.53	P00590
553033			12.59	16.93	4.34	P01524
801001			12.95	19.21	6.26	Ninguno
801002			12.91	18.54	5.63	P1371
801003			12.91	18.54	5.63	P1371
801006			11.22	17.51	6.29	Ninguno
801012			14.62	21.42	6.8	Ninguno
801017			15.23	21.29	6.06	BR11505022
801018			15.08	21.07	5.99	BR11505018
801019			14.17	20.23	6.06	Ninguno
801023			12.04	19.21	7.17	Ninguno
801024			12.04	19.21	7.17	Ninguno
801025			18.89	28.11	9.22	Ninguno
801028			13.39	19.18	5.79	BR11505018
801050			12.9	19.68	6.78	Ninguno
801051			12.99	18.42	5.43	Ninguno
801052			17.87	26.16	8.29	Ninguno
801100			13.58	18.08	4.52	Ninguno
801241			16	24.125	8.125	P878
801256			12.25	19	6.75	P762
801265			16.5	25	8.5	P01006
801278			11.18	16.67	5.49	Ninguno
801281			17.375	23.75	6.375	Ninguno
801291			10	15.375	5.375	P906
801292			13.25	19.25	6	P878
801293			12.51	17.73	5.22	P906
801296			14.5	21.25	6.75	Ninguno

Número de Parte	Tipo de Cuerpo	Longitudes			Accesorios	
		Compimida	Extendida	Viaje		
<b>STRUTS</b>						
801297			12	19.25	7.25	P1498
801299			16.5	25.25	8.75	P906
801311			13.4	20.43	7.03	Ninguno
801312			11.5	16.5	5	Ninguno
801326			15.44	22.17	6.73	P01629
801340			10.375	14.75	4.375	P00906
801351			13.5	16.16	2.66	P1612
801352			13.62	18.19	4.57	P1612
801371			16.89	21.83	4.94	P01613
801372			17.02	24.88	7.86	P00906
801377			13.92	20.25	6.33	Ninguno
801380			11.37	15.7	4.33	
801426			13.625	20.5	6.875	P00762
801427			13.625	20.5	6.875	P00762
801433			13	19.125	6.125	P00762
801434			13	19.125	6.125	P00762
801504			15.125	21.375	6.25	P762
801505			15.125	21.375	6.25	P762
801525			15.25	22	6.75	P808
801565			9.99	13.33	3.34	P1095
801566			12.875	18.75	5.875	P00762
801567			12.875	18.75	5.875	P00762
801570			16.625	23.375	6.75	P762
801571			16.625	23.375	6.75	P762
801572			11.5	18.5	7	P590
801580			12	18	6	Ninguno
801592			12	18	6	Ninguno
801615			14.875	19	4.125	P1439
801616			16	21.875	5.875	P590
801654			12.875	18.875	6	P00762
801655			12.875	18.875	6	P00762
801661			10.27	16.68	6.41	Ninguno
801662			15.53	23.09	7.56	P01700
801663			15.5	23.125	7.625	P853
801672			11.06	18.08	7.02	P1467
801673			12.8	21.18	8.38	Ninguno
801678			13.88	20.12	6.24	Ninguno
801679			13.88	20.12	6.24	Ninguno
801680			16.31	24.21	7.9	Ninguno
801681			16.31	24.21	7.9	Ninguno
801686			12.125	20.375	8.25	Ninguno
801691			16.625	19.5	2.875	P906
801771			10.25	16.875	6.625	P590
801803			13.625	20.125	6.5	P1453
801860			13.375	19.625	6.25	P808



## TABLA DE MEDIDAS

\*Longitudes en pulgadas

Número de Parte	Tipo de Cuerpo	Longitudes			Accesorios	
		Compimida	Extendida	Viaje		
<b>STRUTS</b>						
801871			13.375	19.625	6.25	Ninguno
801872			13.375	19.625	6.25	Ninguno
801873			14.875	23.125	8.25	Ninguno
801874			14.875	23.125	8.25	Ninguno
801897			12.75	16.375	3.625	P01095
801920			14.75	21.125	6.375	P1526
801925			12.625	19.625	7	P1328, P1329
801933			13.875	20.5	6.625	P00986
801941			13	18.875	5.875	P00839
801951			13.25	18.75	5.5	P808
801952			13.25	18.75	5.5	P808
801953			15.5	22.5	7	P808
801954			15.43	22.5	7.07	P808
801962			12.83	18.49	5.66	P589
801963			12.875	18.5	5.625	P1449
801964			13.25	19.5	6.25	P1438
801968			14.375	20.125	5.75	Ninguno
801969			14.375	20.125	5.75	Ninguno
801973			11.375	17.75	6.375	P588
801979			13.875	20.125	6.25	P808
802105			12.83	18.78	5.95	P00762
802106			12.83	18.78	5.95	P00762
802116			13.6	20.64	7.04	P00808
802130			13.38	20.29	6.91	Ninguno
802143			14.53	21.1	6.6	P00762
802144			14.53	21.1	6.6	P00762
802199			11.55	17.91	6.36	P01460
802200			11.55	17.91	6.36	P01460
802205			14.42	22.06	7.64	P01418
802206			14.42	22.06	7.64	P01418
802207			15.97	24.49	8.52	P00808
802208			15.84	24.49	8.65	P00808
802211			16.81	21.17	4.36	P01418
802212			16.81	21.17	4.36	P01418
802240			13.62	20.49	6.87	P00762
802241			13.62	20.49	6.87	P00762
802248			19.83	24.98	5.15	P01522
802263			12.25	18.938	6.688	P00762
802264			12.25	18.938	6.688	P00762
802267			15.04	22.21	7.17	P00762
802268			15.04	22.21	7.17	P00762
802275			15.14	21	5.86	P00808
802295			13.78	20.09	6.31	P00808
802296			13.78	20.09	6.31	P00808

Número de Parte	Tipo de Cuerpo	Longitudes			Accesorios	
		Compimida	Extendida	Viaje		
<b>STRUTS</b>						
802379			13.1	19.8	6.7	P00762
802401			12.69	18.98	6.29	P00906
802497			11.38	15.87	4.49	P00906
802591			12.22	18.74	6.52	Ninguno
802896			12.29	19.14	6.85	
MW004			14.17	20.07	5.9	BE17110604
MW005			13.22	20.39	7.17	Ninguno
MW009			14.29	20.63	6.34	P762
MW013			14.29	20.63	6.34	P762
MW014			13.85	20.47	6.62	P839
MW016			12.44	18.27	5.83	P839
MW202				21.53		P01006
MW265			16.5	25.03	8.53	P01006
MW815			13.38	19.72	6.34	Ninguno
MW816			14	22.91	8.91	Ninguno
MW817			14	22.91	8.91	Ninguno
MW853			13.54	20.47	6.93	P00986
MW871			13.42	19.68	6.26	Ninguno
MW872			13.42	19.68	6.26	Ninguno
MW873			14.88	23.07	8.19	Ninguno
MW874			14.88	23.07	8.19	Ninguno
MW933			13.54	20.47	6.93	P00986



# INTERCAMBIOS

MONROE	KYB	BOGE
1000	343240	32184
1089	443375	32034
1195	441110	32472
1401		35096
1406	444255	35053
1407	444245	35054
1408	443078	32219
1409	344046	32194
1412	444323	35004
1414	444240	35039
1415	444243	35038
1419		35016
1420		35016
1538	443367	32065
2545	444256	32058
2592	443375	32057
3116	442035	32236
3147	443403	32291
3155	32163	
3272		32165
5505	348019	
5506	348041	832730
5507	343328	832683
5507	343328	832683
5509	348062	
5510	349087	
5515	349246	
5520	349228	
5525	349212	
5530	349219	
5533	553308	
5536	343464	
5537	348036	832691
5540	553389	
5546	349219	
5546	349219	
5600	344450	
5601	343426	
5604	349052	832538
5605	341480	
5605	343381	
5606	341237	
5607	343412	832608
5609	343479	832616
5611	344459	832542
5612	341419	930 110
5613	341327	930 109

MONROE	KYB	BOGE
5617	5510000	
5618	5510001	
5621	348002	832604
5624	343442	832535
5626	343458	832601
5629	551134	
5630	348018	
5637	349093	832594
5639	341658	832595
5645	349194	
5647	349136	
5648	341404	
5652	343304	832385
5656	349107	
5660	348014	832616
5661	343478	832620
5663	348032	832694
5667	3440022	
5672	349098	
5673	348029	
5678	349194	
5682	348021	832713
5682	3440007	
5683	343413	
5695	343432	32482
5696	343307	832471
5697	343413	
5698	348019	
5751	343137	
5753	344098	
5753	KG4613A	
5754	343128	
5754	KG4515	
5756	343127	
5765	KG4550	
5778	343454	832546
5778	343455	832291
5779	349043	832610
5780	343454	832546
5781	343319	832534
5783	349026	832568
5784	344363	832609
5785	343455	832291
5788		832564
5791	343328	832536
5792	555700	832537
5794	343423	832603

MONROE	KYB	BOGE
5796	348038	832395
5798	343346	930 134
5801	343128	832276
5803	341164	
5811	KG4507	
5818	343135	32165
5820	KG5508	
5821	343129	
5821	KG4513	
5826	341271	832370
5831	343131	
5837		32090
5839	343135	
5839	KG5519	
5843	KG4531	
5845	343161	
5861	343162	832271
5867	343211	
5868	333304	MP8358
5870	341070	
5870	343042	
5870	KG3765	
5870	KG4766	
5870	KG5561	
5877	342014	
5877	KG4192	
5896		832257
5897	343160	832244
5921	KG4538	
5928	KG5787A	
5930	344270	
5947	KG4539	
5948	334266	MP8459
5960	343128	832272
5961	343135	832272
5962		832221
5966	334184	
5967	334185	
5968	344433	832286
5969	344424	
5974	343255	
5984	343348	832430
5986	343291	832154
5989	343385	832498
5990	344395	832580
5997	334364	
5998	334365	



# INTERCAMBIOS

MONROE	KYB	BOGE
5999	335040	950 010
31000	344429	835020
31029	KG4616	
31069	343219	32002
31089	343144	832034
31094	344090	832408
31125		32036
31131	554163	32032
31162	344046	32194
31176	553311	32091
31197	343462	832480
31538	343143	832141
31542	343144	
31542	KG5529	
32022		32031
32066	343128	832276
32067	554209	
32073	554233	
32073		32032
32075		835016
32080		835115
32113	343208	835039
32118	345626	
32118		32067
32127	344066	835090
32128		832036
32132	344040	
32132	344083	832025
32143	343135	
32143	KG5524	
32164		835020
32186	344041	835097
32191		32075
32194	344042	835096
32196	344435	835104
32197	344089	835105
32202	343161	
32202	743020	
32206	343208	832279
32212	344082	832633
32214	344094	
32215	344096	
32217	344430	832637
32224	344265	835091
32225	344263	835092
32227	344049	835053
32231	344077	835054

MONROE	KYB	BOGE
32233	344080	835106
32235	344268	835232
32237	344396	835188
32238	344079	835189
32239	344077	835054
32242	KG4521	
32243	344049	835053
32245	344202	
32250	344093	
32251	344095	32290
32252	344088	835104
32253	344269	835054
32254	344266	835091
32254		835101
32258	344047	
32258	KG4611A	
32258	KG5433	
32259	344381	835091
32259	344388	835107
32260	344369	835115
32260	344381	
32263	344266	835091
32264	344041	835093
32265	344263	835093
32267	344370	
32268	344371	835115
32269	344396	835105
32271	565022	
32271	KG54304	
32271	KG5477	
32272	565023	
32272	KG54308	
32275	344291	835194
32277	344372	835099
32278	344365	835216
32278	344384	835092
32279	344376	835101
32280	344049	
32283		835183
32284		835115
32285	344272	
32285	KG5406	
32286		835115
32287		835227
32290	344080	835106
32292	343410	832625
32293	344448	832632

MONROE	KYB	BOGE
32294	344448	832632
32295	344448	832632
32296	341302	835107
32297	343160	32244
32300	344042	835096
32302	344367	835184
32303	344268	835187
32304	344267	835231
32306	344403	
32315	344359	
32315	KG5745	
32316	343247	
32318	344081	835222
32319	344378	835196
32322	344267	835185
32323		835183
32324	344374	
32325	344079	
32326	344380	835206
32327	344365	835241
32328	344381	835206
32329	344385	835241
32330	344396	835189
32333	344338	832438
32335	343388	
32335	KG54318	
32336	344298	
32336	KG54337	
32337	344299	
32337	KG54338	
32338	344341	835104
32339	344342	835105
32340	344402	835206
32341	344385	835207
32345	344436	
32346	341302	835107
32347	344381	
32348	344384	835092
32350	344381	835091
32355		832286
32356	344370	835190
32357	344382	835115
32358		835213
32359	344419	
32362	344266	835091
32363		835174
32365	344373	835211



# INTERCAMBIOS

MONROE	KYB	BOGE
32366	344364	835101
32370		835213
32372	344077	
32373		835206
32377	344085	
32377	KG5420	
32381	344076	835053
32382		835053
32383	343209	
32385	344086	835074
32388	344294	
32389	344295	
32390	344398	835099
32391	344385	835100
32392	344399	
32400	349123	835100
32403	343348	832430
32404	348038	832395
32405	553345	930 106
32406	553346	930 105
32407	344496	
32410	344395	832580
33033	344068	835039
33033		835185
33049	343135	832277
33050	KG5508	
33059		32001
33076		835213
33084	344072	835038
33086	344073	835097
33095	343164	832221
33095	344384	835092
33101	KG4501	
33108	343160	832244
33127	343128	832272
33128	343135	832272
33134	344110	832271
33134		835115
33137		835115
33146	349031	32382
33154	343308	835099
33154		832471
33156	344408	832547
33157	343470	832387
33158	348004	832386
33159	345059	832600
33160	348015	832607

MONROE	KYB	BOGE
33178		835179
33179		835101
33181		835211
33182		835101
33187	344356	
33193	349125	
33195	343454	832546
33196	349093	
33274	344081	835222
33274	344353	
33275	344378	835196
34501	344381	
34504	344381	835091
34514	344398	
34515	344093	
34519		835101
34520	349123	835100
34521	344385	835099
34522		835107
34528	341302	835107
34655	344267	835184
34656	344268	835187
34657	344267	835231
34672		835185
34674		35008
34675	344380	835206
34676	344365	835241
34677	344381	835206
34678	344385	835241
34681	344267	835184
34684	344370	835190
34685	344382	835115
34686		835120
34686		835213
34687		35085
34689		835090
34690		835074
34692	344384	835092
34692		835115
34694		835054
34729	344049	835053
34730		35111
34730		835020
34732		32058
34736		835115
34736		835120
34740		835096

MONROE	KYB	BOGE
34741	344266	
34750	344066	835090
34754		835053
34755	554233	
34759		835115
34760		835097
34761		835115
34762	344041	835093
34763	344263	835093
34766	344341	835104
34767		35097
34769	344342	835105
34770	344371	835054
34776		835099
34777		835020
34777		835179
34778		835101
34778		835227
34781		835211
34782		835101
34785	344081	835222
34785	344305	32289
34786	344304	32288
34786	344378	835196
34790	344093	
34794		835101
34796		835107
34798	344266	835091
34802	KG4026	
34803	344429	835020
34804	341302	835107
34817	344068	835039
34824	344072	835038
34831	344066	835090
34832	344266	35008
34839		835120
34853		35085
34854		835090
34868		835074
34899	343247	835115
34900		35016
34901		835054
34904		835020
34905	344085	
34906	344272	
34909		835115
34910	344073	835097





# INTERCAMBIOS

MONROE	KYB	BOGE
34911		835115
34926		835053
34927	344077	835214
34934		835097
34944		835039
34945		835096
34953	343209	
34958		835020
34959		835227
34960		35034
34963	344077	835054
34968	343208	832279
34983	344265	835091
34985	344263	835092
37011	344049	835053
37013	344396	835189
37014	344079	835189
37015	344269	835054
37016	344305	32289
37017	344304	32288
37019	344083	832025
37021	344041	835097
37022	344430	832637
37024	343135	832277
37026	344088	
37027	344089	835105
37029	344090	832408
37030	341372	835227
37031	344054	
37032	344202	
37033	344081	835222
37036	344076	
37037	344077	835214
37040	344067	
37041	344072	835038
37046	344086	35084
37047	343208	832219
37047	343208	832279
37049	344068	835039
37052	344077	835054
37053	344264	
37060	554184	835236
37061	553257	835234
37062	344266	
37063	344081	832276
37064	344082	832633
37065	344080	835106

MONROE	KYB	BOGE
37066	344094	
37067	345022	950 075
37068	345023	930 129
37069	344095	
37070	343247	
37072		832483
37073	344046	832280
37074	344431	
37077	343208	832279
37078	344429	835020
37081	344088	835104
37082	344396	835105
37083	344088	835104
37086	344263	835093
37091		950 034
37094	344294	930 065
37096	344295	930 066
37098	344055	835235
37099	344042	835096
37100	344430	
37101	343403	
37108	344430	
37109	344469	835236
37110	344291	835194
37111	343410	832625
37112	344448	832632
37113	344448	832632
37114	344448	832632
37116		930 077
37117	344371	
37120	344091	
37121	344092	
37121	344300	
37122	341302	835107
37123	344080	835106
37129	344042	835096
37130	344266	835091
37131	344267	835184
37135	344479	
37137	344081	835222
37137	344308	930 068
37138	344378	835196
37138		835105
37140	344378	
37144	344267	835185
37147	349054	
37148	344308	

MONROE	KYB	BOGE
37153	344397	835188
37154	344377	
37156	344338	832438
37157	349040	
37158	343388	
37159	344298	
37160	344299	
37161	344341	835104
37162	344342	835105
37163	349092	
37171	554184	835236
37172	553257	835234
37172		835211
37177	341302	835107
37183	345022	950 075
37184	345023	930 129
37195		832484
37196		832483
37199	343272	930 135
37203	554185	930 011
37204	343379	930 089
37217	344356	930 072
37218	344353	930 077
37219		950 034
37220	553236	
37225	344294	930 065
37225	553238	
37226	344295	930 066
37226	553237	
37231	553245	
37238	554243	
37239	554242	
37240	344358	
37241	343395	930 073
37242	343395	930 073
37244	345024	
37245	344469	835236
37246		930 077
37250	344300	
37251	345042	930 117
37252	345042	930 117
37253	345066	930 117
37269	344440	
37270	341340	950 047
37270	349185	950 047
37273	345067	
37274	345056	



# INTERCAMBIOS

MONROE	KYB	BOGE
37275	345075	
37275	555060	
37276	345068	
37279	349010	930 145
37280	349010	930 145
37282	344439	930 095
37283	344479	
37284	344308	930 068
37285		835105
37289	349024	930 159
37290	349117	
37298	349054	
37301	344308	
37301	344480	
37302	349068	930143
37302	349068	
37308	343435	
37310	341454	
37310	349040	
37312	349027	
37315	349125	
37316	339220	
37317	349092	
37318	344356	930 072
37319	344456	930 150
37320	344463	835239
37321	343425	835239
37326	349095	
37327	349142	
37328	349097	930 163
37331	349070	
37336	349198	
37338	349076	
37339	349151	
37345	3440067	
37355		930 021
37356	343470	832387
37363	349237	
37366	345059	
37368	339398	
37368	339399	
37368	554095	
37369	554354	
37370	349078	
37371	343827	
37372	344493	
37372	554395	

MONROE	KYB	BOGE
37373	344204	
37373	554396	
39001	553177	
39001	553178	
39001	KG4548	
39002	KG4530	
39006	KG5533	
39006	KG5554	
39020	KG4727	
39020	KG4742	
39021	KG4726	
39021	KG4743	
39028	KG5783	
39028	KG6796	
39028	KG6797	
39044	553237	
39045	553245	
39102	343281	
39104	554234	930 040
39105	341493	950 077
39129	553389	
39130	553381	
39131	551130	
39132	551131	
39134	551608	
39135	551606	
40038	344381	
40044		MP8377
40046		MP8376
40047		MP8384
40049	344611	
40050	551104	
58263	341198	MP8169
58523	341341	MP8461
58645	344353	
71026	333755	MP8334
71027	333756	MP8335
71029	334835	MP8380
71030	333310	MP8320
71030	335041	950 011
71031	333311	MP8319
71032	341282	832496
71033	334947	MP8378
71036	339758	MP8311
71038		MP8384
71039	333765	MP8382
71040		MP8383

MONROE	KYB	BOGE
71042	333729	
71054		950 135
71055		MP8702
71056	338741	MP8297
71058	339741	MP8613
71058	339741	MP8613
71059	332144	
71060	332145	
71061	332502	MP8570
71062	332503	MP8571
71063	332144	
71100	340019	
71102	341467	
71105	334367	
71105	551104	
71106	334367	
71112	341924	
71113	341276	
71114	341376	
71119	341480	
71124	341419	930 110
71124	341474	
71125	341327	930 109
71126	341479	MP8295
71128	339246	
71130	339247	MP8564
71131	339248	MP8563
71138	5510000	
71139	5510001	
71140	551134	
71143	334338	
71144	334339	
71146	341361	930 147
71147	341348	930 148
71202	341007	32161
71265	343191	832237
71266	341094	
71267	341179	
71267	741032	
71276	341164	
71278	341194	832322
71281	341244	832295
71285	341126	
71285	341127	
71285	341143	
71285	741015	
71285	741016	



# INTERCAMBIOS

MONROE	KYB	BOGE
71286	341176	
71292	341198	MP8169
71293	341271	832370
71296	335022	950 038
71297	335023	950 037
71299	341258	MP8325
71302	335030	950 036
71304	341207	
71309	334945	
71311	341651	MP8295
71312	341279	832322
71313	334946	
71321	341326	
71322	341327	
71326	341281	
71326	341478	
71327	334195	MP8357
71327	341341	MP8461
71332	341814	
71335	341207	
71339	341258	
71339	741050	
71340	341311	MP8418
71341	331016	950 020
71347	551093	
71351	551083	
71353	341374	950 060
71357	341251	
71358	341600	930 120
71359	341279	832454
71361	341661	930 054
71362	341662	930 054
71363	341277	
71363	741041	
71371	341340	950 046
71373	341382	832553
71377	341603	
71379	341368	832606
71380	341463	930 078
71381	341437	
71400	333304	MP8358
71401	333305	MP8357
71404	333205	
71405	333206	
71406	334228	MP8273
71410	334191	
71416		MP8172

MONROE	KYB	BOGE
71417	341245	
71417	341477	
71418	334265	MP8460
71424	333320	
71424	333350	
71425	333321	
71425	333351	
71426	334336	MP8454
71427	334337	MP8453
71429	334184	
71430	334185	
71433	331021	MP8391
71434	331022	MP8390
71435	334479	
71436	334265	
71437	235624	
71437	334266	
71451	334364	
71451	339072	
71452	334365	
71452	339072	
71453	335040	950 010
71454	335041	950 011
71461	334366	
71462	334367	
71490	334338	
71492	334340	
71493	334341	
71494	344399	
71496	334428	
71497	334429	
71498	334263	
71498	334269	
71499	334264	
71499	334270	
71504	333348	MP8264
71505	333349	MP8265
71515	333909	
71515	333919	
71525	334812	MP8241
71549	333119	
71557	334378	
71559	334125	
71565	341650	MP8294
71566	333219	MP8206
71567	333220	MP8207
71568	334321	

MONROE	KYB	BOGE
71570	335022	950 038
71571	334158	
71571	335023	950 037
71572	334335	MP8308
71573	334159	
71573	335030	950 036
71577	331017	930 010
71580	235950	MP8259
71581	334945	
71582	334946	
71584	332108	MP8360
71584	332109	
71586	333275	
71587	333274	
71588	333277	
71589	333276	
71590	334195	MP8357
71590	334195	
71590		950 062
71591	334196	MP8357
71591		950 062
71592	235626	MP8321
71593	334333	950 018
71594	334334	950 017
71597	334317	950 030
71598	334318	950 031
71612	334115	
71613	334116	
71617	334466	MP8178
71642	341140	
71642	741033	
71650	334170	
71654	333209	
71655	333210	
71661	334227	MP8274
71662	334228	MP8273
71662	341174	
71664		MP8143
71665		MP8143
71667		MP8144
71667		MP8214
71668		MP8213
71669		MP8172
71672	334229	MP8279
71676	334227	
71678	339086	
71681	334479	



## INTERCAMBIOS

MONROE	KYB	BOGE
71684	339016	
71685	335037	
71686	334295	MP8275
71687	235620	
71691	341257	MP8324
71694	333183	
71696	334268	
71697	341163	
71698	341141	
71716	235002	
71728	236001	
71750	334386	
71751	234016	
71771	234019	
71780	235054	
71781	334325	
71781	633115	MP104
71782	633116	MP105
71795	334431	950 013
71803	235008	
71803	235009	
71808	235021	
71814	234005	
71828		MP8374
71829		MP8375
71844	341135	
71846	333051	
71847	333052	
71851	333331	
71852	333332	
71853	333340	MP8020
71857	333118	
71859	339023	
71860	339024	
71861	339025	
71862	339026	
71871	633115	MP104
71872	633116	MP105
71873	632072	MP106
71874	632073	MP107
71893	334433	
71894	235038	
71897	341650	
71898	234053	
71899	234054	
71900	334486	MP8352
71901	334487	MP8351

MONROE	KYB	BOGE
71918	339100	
71920	235903	MP8211
71926		MP8080
71927		MP8081
71932	334015	
71933	333340	MP8020
71942	334467	MP8177
71943	339019	MP8180
71944	339020	MP8179
71945	335057	
71946	335058	
71951	333114	MP8480
71952	333115	MP8481
71953	333116	MP8483
71954	333117	MP8482
71959	234902	
71960	234901	
71962	235060	MP8226
71963		MP8226
71964	334188	MP8225
71968	333219	MP8206
71969	333220	MP8207
71972	339081	950 066
71979	334170	
71984	333357	
71985		MP8145
71986		MP8146
71987	333431	
71989	341174	
71992		950 093
71992		MP8143
72105	333345	MP8251
72106	333344	MP8251
72107	333310	MP8251
72108	333311	MP8251
72114	339114	MP8406
72115	339115	MP8407
72118	339242	
72119	339243	
72120		-
72123	341330	MP8389
72125	339206	
72127	235625	
72130	339088	
72136	340089	
72138	235920	MP8434
72139	332131	

MONROE	KYB	BOGE
72141	333382	832605
72142	334420	MP8531
72143	331048	950 028
72144	331049	950 029
72147	334267	
72148	334268	
72179	339084	MP8538
72185	331027	MP8506
72186	331028	MP8505
72191	333508	
72192	333509	
72193	333510	
72194	333511	
72195	341351	
72199	339051	MP8387
72200	339052	MP8387
72205	334386	
72205	340044	
72207	334389	
72207	341449	MP8635
72208	334388	MP8035
72209	339057	950 024
72210	339058	950 025
72211		MP8035
72215	235908	
72215	334394	
72215	339210	
72216	235909	
72216	334395	
72216	339211	
72217	339188	
72218	339189	
72219	334502	
72220	334503	
72221	334504	
72222	334505	
72229	339072	
72230	339073	
72231	335061	
72237	334431	950 013
72237		MP8420
72238	331601	
72243	341449	MP8635
72245	333385	
72248	341439	832369
72248	341666	
72257	334840	MP8561



# INTERCAMBIOS

MONROE	KYB	BOGE
72258	334841	MP8562
72261	341405	MP8553
72263	334700	MP8533
72264	334701	MP8534
72265		MP8374
72266		MP8375
72267	334380	
72268	334381	
72269	334644	950 064
72270	334644	950 064
72271	334454	
72272	334455	
72275	339031	950 010
72276	339032	950 011
72281	340022	
72281	340024	
72281	341476	
72283	334477	
72286	339074	MP8555
72287	339075	MP8556
72288	334472	MP8379
72289	334473	MP8379
72290	333331	MP8656
72291	333332	MP8655
72295	333418	MP8536
72296	333417	MP8537
72297	333516	MP8528
72298	333517	MP8529
72301	333490	
72307	339023	
72308	339024	
72309	339025	
72310	339026	
72311	335808	MP8419
72312	335808	MP8419
72317	334360	950 056
72318	334361	950 057
72319	334362	950 058
72320	334363	950 059
72343	339039	
72347	334433	MP8485
72348	334433	MP8485
72351	333390	MP8520
72352	333390	MP8521
72355	339082	MP8572
72356	339083	MP8573
72362	551097	-

MONROE	KYB	BOGE
72363	339100	
72364	339100	
72365	339100	
72366	339100	
72367	334658	MP8495
72368	334659	MP8496
72369	340047	
72371	333316	
72372	333317	
72374	333365	
72378	333602	MP8502
72379	333603	MP8501
72384	340048	
72392	339190	MP8500
72393	339191	MP8499
72397	341373	-
72398	341402	-
72399	341425	832621
72401	341668	832590
72408	341666	MP8632
72418	341348	930 148
72423	334464	950 108
72424	334465	950 109
72431	335057	-
72433	335058	
72435	335057	
72437	339080	950 066
72437	339124	950 088
72438	339081	950 066
72438	339125	950 089
72443	339140	
72444	339141	
72450	333420	MP8525
72451	333419	MP8524
72465	333356	
72468	333432	-
72469	333431	-
72476		950 093
72477		950093
72489	334846	MP8174
72490	334847	MP8173
72491	339261	
72492	339262	
72493	339155	
72494	339156	
72496		MP8173
72497	341492	930 078

MONROE	KYB	BOGE
72509	333420	MP8525
72510	333420	MP8524
72511	341499	930 160
72517	340089	
72517	341176	
72518	339272	
72519	335839	950 067
72520	332130	
72521	332131	
72522	341499	
72523	341499	
72526	335095	
72526	335845	
72527	335094	
72527	335844	
72531		MP8295
72534	341203	MP8168
72536	339220	
72537	339221	
72538	341198	MP8169
72539	341202	832370
72541	339263	
72542	339264	
72544	341258	
72545	341258	
72549	334834	
72562	340040	
72562	340041	
72563	340044	
72568	341449	MP8635
72568	341450	
72569	341449	MP8635
72589	235952	MP8035
72591	235901	MP8136
72593	334337	MP8453
72593		MP8035
72594	235624	
72596	340038	MP8553
72596	340039	
72597	339114	
72598	339115	
72599	341363	
72601	333741	MP8559
72602	332504	MP8567
72603	332505	MP8568
72608	339196	950 085
72609	339197	950 086



## INTERCAMBIOS

MONROE	KYB	BOGE
72614	334317	950 030
72614		MP8421
72618		MP8303
72619		MP8305
72621	339293	
72623	332113	
72623	333225	
72623	333319	
72624	341449	MP8635
72625	341449	MP8635
72626	339381	MP8646
72627	339382	MP8645
72633	334835	MP8274
72634	341439	832369
72638	334983	
72641	339086	
72642	339087	
72645	333718	MP8398
72647	339361	
72648	339362	
72652	334478	
72653	334986	
72654	334985	
72659	334480	MP8167
72659	338009	MP8656
72660	334481	MP8166
72660	338010	MP8655
72663	339381	MP8646
72664	339382	MP8645
72668	341257	MP8354
72699	551117	
72706	333516	
72707	333517	
72745	334835	
72756		MP8142
72765		-
72766		-
72770	340047	-
72774	3357500	
72775	3357501	
72780	235041	
72781	339292	
72782	339293	
72783	339292	
72784	339293	
72785	235041	
72786	235042	

MONROE	KYB	BOGE
72789	235043	
72826	361005	MP002
72888	334692	
72889	334693	
72890	333298	MP307
72891	333299	MP307
72892	334846	MP8173
72893	334847	MP8174
72894	341499	930 160
72895	341499	930 160
72896	340093	
72899		MP8630
72901	339331	
72902	339332	
72902	341174	
72903		MP8143
72909		MP8144
72915		MP8294
72925	3340053	
72926	3340054	
72927	3340053	
72928	3340054	
72936	339311	
72937	339312	
72938	339404	
72939	339405	
72947	339367	-
72948	339367	-
72949	339422	
72950	3340063	
72951	3340064	
72952	3410018	
72955	339311	
72956	339312	
72957	340115	
72970	3340140	
72971	3340141	
72974	334364	
72975	334365	
72978	339336	
72978	339368	
72979	339337	
72984	340044	
72989	3340047	
72990	3340048	
72991	3410014	
72997	339199	

MONROE	KYB	BOGE
72998	339198	
73004	338737	
73005	338737	
73009	333425	
73009	338094	
73009	3330018	
73010	333426	
73010	338095	
73010	3330019	
73015	338087	
73016	338088	
73017	333415	
73018	333414	
73019	3330080	MP8673
73020	3330079	MP8674
73044	335619	
73044	335620	
73045	339365	
73046	339366	
73049	339292	
73050	339293	
73244	365075	
73312	366005	
73951	341138	
81265	343191	832237
81278	341194	832322
81281	341244	832295
81291	343160	832244
81299	343164	832221
81311	341651	MP8295
81312	341279	832322
81504	333348	MP8264
81505	333349	MP8265
81525	334812	MP8241
81565	341650	MP8294
81570	344072	-
81571	344072	835038
81572	334335	MP8308
81661	334227	MP8274
81662	344395	832580
81672	334229	MP8279
81673	334230	MP8284
81679	344399	
81680	344385	835100
81681	344398	835099
81682	344295	
81683	344294	



# INTERCAMBIOS

MONROE	KYB	BOGE
81686	334295	MP8275
81691	344086	835074
81771		835174
81772	344266	835091
81831	344079	-
81859	344081	835222
81861	343247	
81875	344403	
81878	344267	835231
81897	341650	
81920	235903	MP8211
81925	344376	835101
81942	344371	835115
81945	344370	
81951	333114	MP8480
81952	333115	MP8481
81953	333116	MP8483
81954	333117	MP8482
81959	234902	
81960	234901	
81962	344095	32290
81963	344093	
81964	334188	MP8225
81973	334316	MP8122
81992	344077	835054
82591	235901	MP8136
550010	344081	
550011	343135	
553002	335810	
801001	333702	MP8283
801002	341953	MP8291
801003	333702	MP8261
801006	333700	MP8176
801007	334846	MP8174
801008	334847	MP8173
801012	341712	MP8175
801017	333708	MP8298
801018	333701	MP8283
801019	333702	MP8283
801023	234902	MP8139
801023		MP8174
801024	234902	MP8140
801024		MP8173
801025	338741	MP8297
801028	338742	MP8292
801050	333755	MP8498
801051	333756	MP8497

MONROE	KYB	BOGE
801052	339711	MP8532
801241	341176	
801256	341125	
801265	343191	832237
801278	341194	832322
801281	341244	832295
801282		MP8295
801291	341203	MP8168
801292	341198	MP8169
801293	341202	832370
801297	341191	
801299	341258	
801311	341651	MP8295
801312	341279	832322
801326	341281	
801340	341311	MP8418
801351	564002	
801351	KG9025	
801352	343410	
801377	334170	
801426	334336	MP8454
801427	334337	MP8453
801433	331021	MP8390
801434	331022	MP8391
801452	339072	-
801504	333348	MP8264
801505	333349	MP8265
801525	334812	MP8241
801565	341650	MP8294
801566	333219	MP8252
801567	333220	MP8251
801570	344072	
801571	344072	835038
801572	334335	MP8308
801578	235951	MP8260
801580	235950	MP8259
801592	235626	MP8321
801615	334292	MP8303
801616	334294	MP8305
801661	334227	MP8274
801662		MP8274
801672	334229	MP8279
801673	334230	MP8284
801678	339086	
801679	339087	
801680	334478	
801681	334479	

MONROE	KYB	BOGE
801682	334480	MP8167
801683	334481	MP8166
801686	334295	MP8275
801691	341257	MP8354
801771	234019	MP8008
801772	344266	835091
801803	235009	
801803	734013	
801845		MP8142
801853	333340	MP8020
801859	235041	
801860	235041	
801861	235042	
801862	235043	
801871	333089	MP8104
801872	333090	MP8105
801873	332056	MP8106
801874	332057	MP8107
801875	341174	
801878		MP8143
801897		MP8294
801900	334486	
801901	334487	
801920	235903	MP8211
801925	344376	835101
801933	333340	MP8020
801945	341138	
801946	341139	
801951	333114	MP8480
801952	333115	MP8481
801953	333116	MP8483
801954	333117	MP8482
801959	234902	MP8139
801960	234901	MP8140
801962	344095	32290
801963	344093	
801964	334188	MP8225
801968	333219	MP8207
801969	333220	MP8206
801973	334316	MP8122
801979	334170	
801980	334171	
801989	341174	MP8170
801992		MP8143
802105	333344	MP8252
802106	333345	MP8251
802143	331048	



# INTERCAMBIOS

MONROE	KYB	BOGE
802143	331050	
802144	331049	
802144	331051	
802199	339051	
802200	339052	
802248	344110	832271
802263	334700	
802264	334701	
802275	339031	-
802295	333418	-
802296	333417	-
802591	235901	MP8136
902034	340054	
902972	SM5276	
902972	SM5435	
902972	SM5436	
902998	SM5334	
903947	SM5152	
903947	SM5311	
903947	SM5320	
903983	SM5243	
903997	SM5205	
904958	SM5458	
904983	SM5427	
904983	SM5429	
904987	SM5332	
904988	SM5472	
904988	SM5473	
904988	SM5561	
904988	SM5562	
905916	SM5661	
905930	SM5597	
905934	SM5565	
905935	SM5566	
905936	SM5491	
906973	SM5663	
906974	SM5662	
907985	SM5767	
908948	SM5609	
911034	344049	835053
911043	344266	835091
911044	344263	835092
911050	344265	835091
911085	344041	835093
911086	343219	32002
911091	344073	835097
911096	344066	835090

MONROE	KYB	BOGE
911128	344388	
911131	344267	835184
911132	344268	835187
911133	344367	
911134	344375	
911140	344379	
911149	344380	835206
911150	344365	835241
911151	344381	835206
911152	344385	835241
911164	344385	
911166	344384	835092
911168	344384	
911173	344370	835190
911178	343160	832244
911178	344381	
911181	344381	835091
911186		835099
911187	344385	
911188		835101
911191	344372	
911192	343162	832271
911193	344364	
911194	344382	835115
911220	344093	
911221	349123	835100
911222	344385	835099
911228	344464	930 113
911229	344465	930 114
911230	344466	930 113
911256		832564
911258	345055	930 075
911259	553345	930 106
911260	553346	930 105
911261	344414	930 057
911262	344415	930 055
911265	344371	835054
911277	344378	930 107
911278	344496	
911304	345626	
911304	3440054	
911332	348029	
911334	554373	
911335	554373	
911501	554246	835206
911502	554249	835241
911503	554233	

MONROE	KYB	BOGE
911504	554209	
911505	554234	930 040
911506	554248	930 041
911508	348032	832694
911514	343304	832385
911514	554163	
911520	554186	
911521	554187	
911530	343381	
911533	345074	930 041
911537	344450	
911540	554231	
911541	554232	
MA791	KG5573	
MA822	SR1002	
MA822	SR4116	
MC888	664024	CR273
MW004	333157	MP148
MW005	441126	32369
MW009	633227	MP020
MW013	441135	32294
MW014	441134	32593
MW016	634821	MP8288
MW202	341007	32161
MW265	443219	32237
MW815	632040	MP068
MW816	632047	MP069
MW817	632046	MP069
MW853	633227	MP020
MW853	633227	MP900
MW871	633115	MP104
MW872	633116	MP105
MW873	632072	MP106
MW874	632073	MP107
MW933	633227	MP020
MW933	633227	MP900

MONROE	SYD	GROB
250089	7000001	G2034
250132	7000395	G5096
250147	7000005	G2291
250157	7000032	4009011
250158	7000033	
250186	7000023	G5097
250194	7000024	G5096
250197	7000021	G2480
250224	7000025	G5091





## INTERCAMBIOS

MONROE	SYD	GROB
250290	7000027	
250300	7000028	G5096
250302		G5184
250303		
250322	7000239	G5185
250410	7000019	6709005
250538	7000004	G2141
250791	7000014	9309001
250794	7000016	2709033
250984	7000018	G2430
400004	7000096	GP148
400005	7000139	G2369
400014	7000142	G2593
400017	7000125	GP298
400025	7000126	4009010
400028	7000127	
400029	7000071	9309002
400105	7000097	GP251
400106	7000098	GP252
400265	7000144	G2237
400295	7000105	2709031
400296	7000106	2709032
400312	7000076	G2454
400426	7000078	6709003
400427	7000079	6709004
400525	7000082	GP241
400871	7000145	GP104
400872	7000146	GP105
400873	7000147	GP106
400874	7000148	GP107
400888	7000137	GC273
400933	7000149	
400964	7000134	GP225

# INSTRUCCIONES IMPORTANTES PARA LA INSTALACIÓN

## UNIDADES DELANTERAS

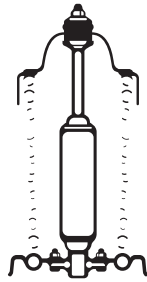

Generalmente se deben de instalar los amortiguadores y las unidades estabilizadoras en la misma posición y en la misma forma que los usados originalmente en el auto. Si las unidades se tuvieran que instalar en forma distinta, se suministran las instrucciones.

**IMPORTANTE:** En algunos casos, al instalar amortiguadores o unidades estabilizadoras delanteras pudiera ser necesario agrandar ligeramente el agujero en el brazo inferior de la suspensión, para permitir el pasaje de la unidad. Esto se puede lograr roscando la orilla interna del agujero, limando o rectificando. Agrande los agujeros sólo lo suficiente para permitir el pase de la unidad.

**CUIDADO:** No lime ni rectifique la unidad.

## UNIDADES TRASERAS

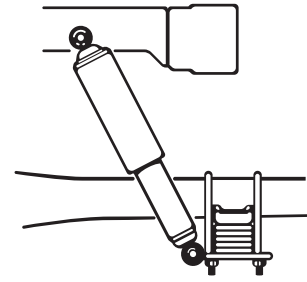

**IMPORTANTE:** Al instalar amortiguadores o unidades estabilizadoras traseras, asegúrese que todas las líneas hidráulicas del freno, las líneas de combustible y los caños de escape, estén libres de la unidad. Todas las distancias se deben verificar con la carrocería del auto arriba y abajo (con las ruedas colgando y la carrocería empujada hacia abajo). Cuando es necesario, mueva todas las líneas y los caños de escape para obtener distancias.

## VASTAGO CON RESALTO

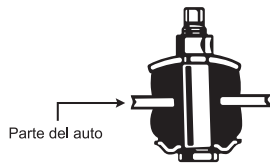

APRIETE LA TUERCA HASTA QUE EL RETÉN ASIENTE EN EL RESALTO

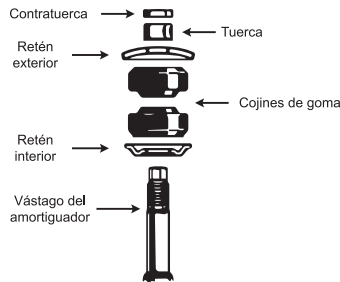

## VASTAGO SIN RESALTO

APRIETE LA TUERCA HASTA QUE LOS COJINES SOBRESALGAN CASI HASTA LA ORILLA EXTERIOR DEL RETÉN. NO APRIETE EXCESIVAMENTE.

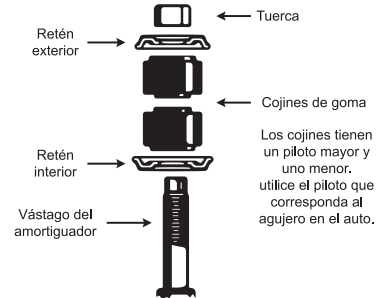
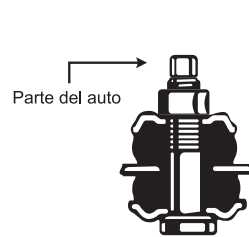

Los cojines tienen un piloto mayor y uno menor. utilice el piloto que corresponda al agujero en el auto.

## ARMADO CON PASADOR CRUZADO

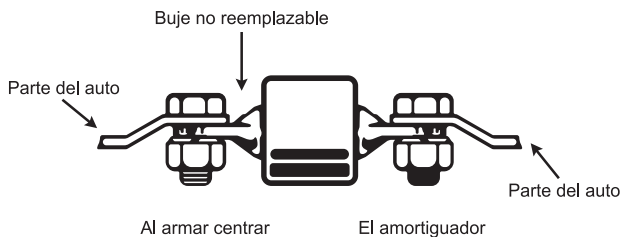

LOS EXTREMOS ACHATADOS DEL PASADOR ESTÁN DISEÑADOS PARA CALZAR EN ESCUADRA CONTRA LA PLACA DE MONTAJE A LA ALTURA NORMAL DEL AUTO. AL INSTALAR, SI LAS PARTES ACHATADAS NO ESTÁN EN ESCUADRA CON LA PLACA, GIRE EL AMORTIGUADOR MEDIA VUELTA PARA MEJOR ALINEACIÓN.

## USE PIEZAS DE MONTAJE DEL PASADOR NUEVAS PARA REEMPLAZAR EL PASADOR ORIGINAL

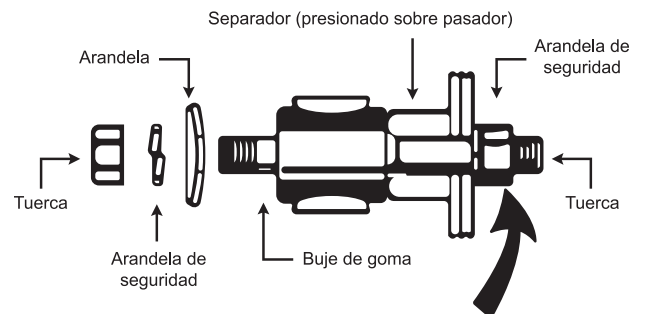

ASEGÚRESE QUE EL PASADOR DE MONTAJE QUEDE APRETADO PARA EVITAR QUE SE AFLOJE.

# INSTRUCCIONES IMPORTANTES PARA LA INSTALACIÓN

## MONTAJE SIN CASQUILLO INTERIOR

SE PUEDE USAR ARANDELA PLANA O CURVA CONTRATUERCA, TOMA NOTA DE LA ARANDELA CURVA CUANDO SE RETIRE EL AMORTIGUADOR ORIGINAL.

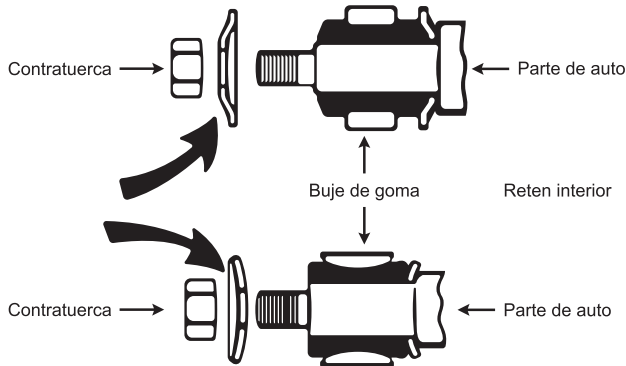

## MONTAJE CON MANGUITO INTERIOR

EL PERNO DE MONTAJE DEBE ESTAR BIEN APRETADO PARA EVITAR RUIDOS EN ESTE TIPO DE MONTAJE.

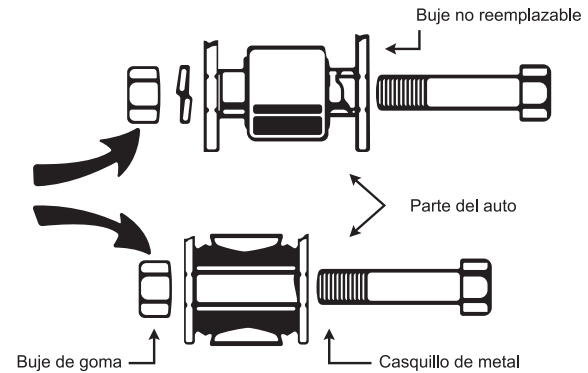

ASEGÚRESE QUE EL MANGUITO DE METAL ESTÁ AISLADO EN EL BUJE DE GOMA, VUELVA A EMPLEAR EL PERNO, LA TUERCA Y LA ARANDELA DE SEGURIDAD DE MONTAJE.

### SE DEBE:

- 1. OBSERVAR LA UBICACIÓN** de todas las piezas de montaje, arandelas, al retirarlas y asegúrese de volver a armar estas piezas en las mismas posiciones.
- 2. PROCEDA CON CUIDADO** al instalar las unidades nuevas. Asegúrese que todos los pernos y las tuercas estén bien apretadas. Verifique las distancias.
- 3. SIGA LAS INSTRUCCIONES ESPECIALES QUE ACOMPAÑAN LAS UNIDADES.**

### NO SE DEBE:

- 1. NO RETUERZA LAS TUERCAS.** Si las tuercas están oxidadas, use un aceite de penetración sobre la rosca, deje pasar unos minutos para que penetre el aceite antes de desenroscar. Si las tuercas se han oxidado al punto que el aceite de penetración no funcione, se recomienda el empleo de un partidor de tuercas; cuidando de no dañar la rosca en el montaje, si es parte del auto.
- 2. NO SUJETE EL VASTAGO PULIDO DEL PISTON** con herramientas durante la instalación. Esto dañará al vástago y hará que falle la unidad.
- 3. NO DEJE COLGAR LAS RUEDAS** al cambiar los amortiguadores de los autos que tienen muelles en espiral traseros o muelles neumáticos.

**MONROE**  
AMORTIGUADORES Y STRUTS

**SIENTE LA DIFERENCIA**

# PUNTOS SORPRENDENTES MONROE

La mayoría de la gente cree que los amortiguadores y struts son necesarios solamente para mejorar el confort en el manejo de su vehículo. En realidad, hacen mucho más que eso. Aquí están varios puntos sorprendentes. ¿Sabía usted que...?

- Bajo condiciones normales de manejo, los amortiguadores y struts golpean un promedio de **1,087 veces** cada kilómetro que usted conduce – **eso es mas de 65 millones de veces en 60,000 kilómetros!**
- Los amortiguadores y struts rara vez se dañan repentinamente por completo. En cambio, se deterioran gradualmente con el tiempo y los kilómetros recorridos, lo que permite que el conductor se acostumbre al cambio en el manejo y al control.
- **Los amortiguadores y struts ayudan a mantener su vehículo en contacto firme con el camino.** Unos amortiguadores y struts desgastados producirán que las llantas boten excesivamente, disminuyendo el control del conductor y la habilidad al frenar.
- **Un vehículo con sólo un amortiguador desgastado puede incrementar la distancia del frenado hasta por 3 metros.**
- Los amortiguadores no pueden ser reparados. Son unidades selladas que deben ser reemplazados una vez dañados.
- **¡Los amortiguadores y struts SON equipo de seguridad!** - Los amortiguadores y struts juegan un papel vital en proteger los componentes de fallas prematuras debido a que minimizan la cantidad de vibraciones a las que son sujetas los vehículos diariamente.
- Ahora que cuenta con los datos, ¿no esta de acuerdo en que los amortiguadores y struts proveen más que solo un viaje confortable? **Proteja su inversión y obtenga una Inspección del Triangulo de Seguridad hoy!**

# GARANTÍA AUTOMÓVILES Y CAMIONETAS

LOS AMORTIGUADORES, CARTUCHOS Y STRUTS OESPECTRUM®, REFLEX®, RANCHO®, GAS-MAGNUM®, MONRO-MATIC PLUS®, MONRO-MATIC®, MONRO-ROADMATIC® Y MONROE® BASES DE AMORTIGUADOR están garantizados contra cualquier defecto de material, fabricación o mal funcionamiento que se presente durante el uso del vehículo operando en condiciones normales; la garantía no cubre el mal uso de los mismos.

## LA GARANTÍA ES LA SIGUIENTE:

- › OESpectrum®, Reflex®, Sensa-Trac®, Gas-Magnum®, Amortiguadores Electrónicos y Amortiguadores autonivelables (Nivomat), CUATRO AÑOS Ó 300,000 kms., lo que suceda primero.
- › Rancho® RS5000, RS5000X, RS7000MT, RS9000XL y QuickLift® Loaded, están garantizados por CUATRO años ó 350,000 kms., lo que suceda primero.
- › Monro-Matic Plus®, CUATRO AÑOS Ó 300,000 kms., lo que suceda primero.
- › Monro-Matic®, DOS AÑOS Ó 150,000 kms., lo que suceda primero.
- › Monro-RoadMatic®, DOS AÑOS Ó 100,000 kms., lo que suceda primero.
- › Max-Lift®, Max-Air®, Monroe® Bases de Amortiguador, DOS AÑOS Ó 50,000 kms., lo que suceda primero.
- › La garantía para vehículos comerciales es de UN AÑO Ó 50,000 kms., (para todas las líneas en autos o camionetas) lo que suceda primero.

## ESTA GARANTÍA NO CUBRE DESGASTE NORMAL OCASIONADO POR USO, NI SE HARÁ EFECTIVO CUANDO LOS AMORTIGUADORES, CARTUCHOS O STRUTS:

- Hayan sido instalados incorrectamente.
- Presenten rayas o marcas en las flechas, ocasionadas por alguna herramienta usada para detener el giro de la misma en la instalación.
- Muestren daños o golpes originados por motivos ajenos al funcionamiento.
- Presenten alguna modificación o alteración en su diseño original de fabricación.
- Presenten signos vitales de abuso en el uso.
- Presenten fallas ocasionadas por la rotura o no instalación de los topes de la suspensión.
- Se instalen en vehículos para los cuales no fueron diseñados y que no correspondan a lo indicado en nuestro catálogo.
- Sean instalados en vehículos que han sido modificados con respecto a su diseño original.

La garantía consiste en la reposición de la pieza por una nueva y no incluye gastos de desmontaje o instalación. Sólo se cambia la pieza dañada y no el PAR.

Para que el usuario goce de esta garantía, deberá entregar los amortiguadores, cartuchos o struts defectuosos junto con la factura original que cumpla con lo establecido en el artículo 29 de la CFF, firmar el Formato de Reclamo de Garantía Último Consumidor debidamente llenado (véase pág. IX) y tapa(s) de la(s) caja(s) de las(s) pieza(s) de reemplazo, estos requisitos son indispensables para el procesamiento de la garantía y para verificar que el producto está dentro de su tiempo de garantía para su reposición.



# FORMATO DE SOLICITUD DE GARANTÍA

Esta sección debe ser completada para asegurar el cambio de producto.

Nombre Instalador \_\_\_\_\_ Teléfono \_\_\_\_\_  
 Nombre Refaccionario \_\_\_\_\_ Teléfono \_\_\_\_\_  
 Dirección \_\_\_\_\_  
 Ciudad/Estado \_\_\_\_\_ Código Postal \_\_\_\_\_

Esta sección debe ser llenada para poder recibir el reemplazo de la pieza ó piezas defectuosas.

## A. INFORMACIÓN DEL CONSUMIDOR

Los requisitos mínimos para ser candidato a garantía son:

- ▶ Ser el comprador original del producto Tenneco (Monroe, Rancho, Walker, Dynamax/Thrush).
- ▶ Presentar la Factura Original de compra del producto Tenneco.

Nota: El cliente conserva el recibo original y documentación para futuras reclamaciones.

Firma del consumidor \_\_\_\_\_ Nombre \_\_\_\_\_  
 Fecha de reemplazo (DD/MM/AA) \_\_\_\_\_ Teléfono consumidor ( ) \_\_\_\_\_

## B. NÚMERO DE PARTE DE REEMPLAZO

Número de Parte Reclamado	Cantidad Piezas	Código de Defecto*	Kilometraje Instalación	Fecha Compra	Fecha Actual	Kilometraje Actual

\*CÓDIGO DE DEFECTO:

- 01) Fuga de aceite
- 02) Unidad rota
- 03) Ruidoso
- 04) Se atora
- 05) Sin gas
- 06) Ajuste
- 07) Otro

Si utiliza "Otro" (07) como código de defecto, por favor describa detalladamente.

\_\_\_\_\_

\_\_\_\_\_

\_\_\_\_\_

\_\_\_\_\_

\_\_\_\_\_



# MONROE®

## AMORTIGUADORES

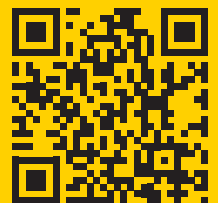

© 2022 DRiV Automotive Inc. All trademarks shown are owned by DRiV Automotive Inc or one of its affiliates in one or more countries.

© 2022 DRiV Automotive Inc. Las marcas que se muestran son propiedad de DRiV Automotive Inc o de una de sus subsidiarias en uno o más países